

PCB LAYOUT

Material

Screw: M2.5, Steel,Zn plated

Shrapnel: Phosphor bronze ,Nickel plated

Pin header: Brass , Tin plated

Housing: PA66, UL94V-0

Electrical

Rated voltage:125V

Rated current: 10A

Wire range:24~18AWG 1.0mm²

Contact Resistance: 20 mΩ

Insulation resistance: 500MΩ/DC500V

Withstand voltage: AC2000V/1min

Mechanical

Temp.Range: -40℃~+105℃

Soldering: 250℃±5℃ for 5S

Torque: 0.2 N.m (1.77Lb. in)

Strip length: 4.5~5mm

Order Information

RHTBY50R-3.50-XXP-4 S XX

Terminal Block

Pitch

No. of Pole

Product Cde:00~99

Screw:S-Slot Screw

C-Cross Screw

Color:4-Green

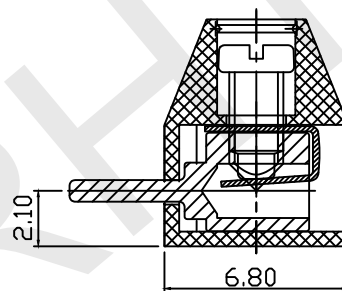
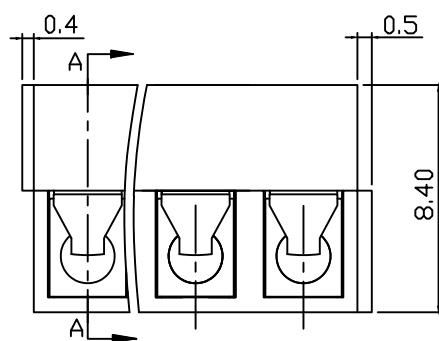

SECTION A-A

RHTECP NINGBO RHT ELECTRONIC CO.,LTD

UNITS:mm

SHEET SIZE: A4

SCALE:---

DRWN BY PAN

Screw Conn Term Block 3.50mm

0~3

3~18

18~50

50~120

CHK'D BY FENG

THIRD ANGLE PROJECTION

±0.12

±0.15

±0.3

±0.5

APPR BY ZHAN

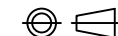

RHTBY50R-3.50-XXP-4S

1

2

3

4

5

6

7

8

9

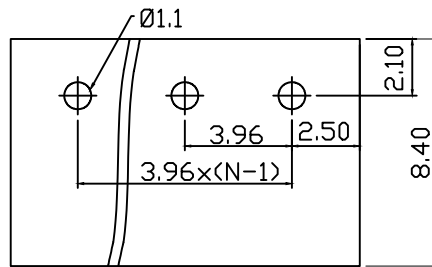
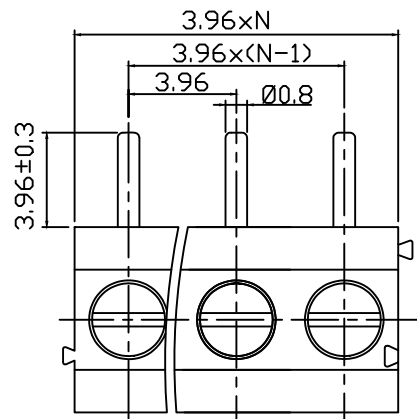

PCB LAYOUT

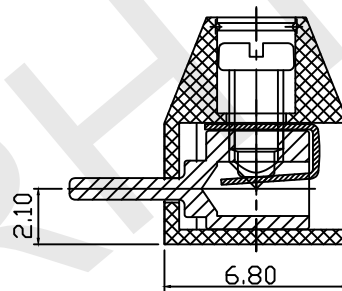
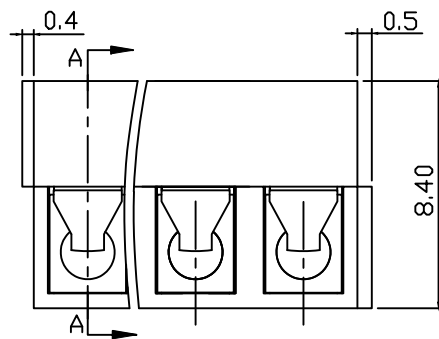

SECTION A-A

Material

Screw: M2.5, Steel,Zn plated
 Shrapnel: Phosphor bronze ,Nickel plated
 Pin header: Brass , Tin plated
 Housing: PA66, UL94V-0

Electrical

Rated voltage:125V
 Rated current: 10A
 Wire range:24~18AWG 1.0mm²
 Contact Resistance: 20 mΩ
 Insulation resistance: 500MΩ/DC500V
 Withstand voltage: AC2000V/1min

Mechanical

Temp.Range: -40℃~+105℃
 Soldering: 250℃±5℃ for 5S
 Torque: 0.2 N.m (1.77Lb. in)
 Strip length: 4.5~5mm

Order Information

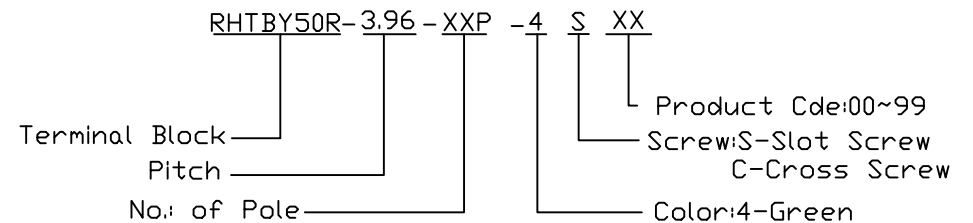

RHTECP NINGBO RHT ELECTRONIC CO.,LTD

UNITS:mm	SHEET SIZE: A4			SCALE:---	DRWN BY PAN
0~3	3~18	18~50	50~120	CHK'D BY FENG	
±0.12	±0.15	±0.3	±0.5	APPR BY ZHAN	

Screw Conn Term Block 3.96mm	
THIRD ANGLE PROJECTION	RHTBY50R-3.96-XXP-4S