

SECTION A-A

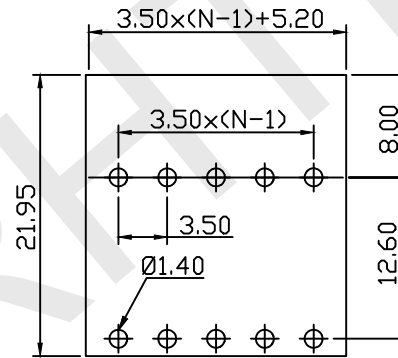
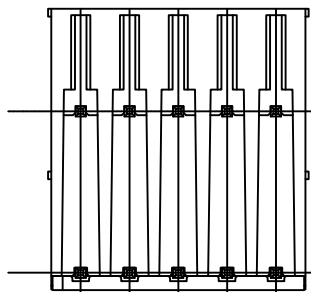

PCB LAYOUT

Material

Housing: PA66, UL94V-0

Pin header: Brass, Tin plated

Electrical

Rated voltage: 300V

Rated current: 8A

Contact Resistance: 20mΩ

Insulation resistance: 500MΩ/DC500V

Withstand voltage: A2000V/1min

Mechanical

Temp. Range: -40°C+105°C

Order Information

RHTBYDBR-3.50-XXP-4 00

Terminal Block

Pitch

No. of Pole

Color: 4-Green

Code: Product Code: 00~99

RHTECP NINGBO RHT ELECTRONIC CO.,LTD

UNITS:mm	SHEET SIZE: A4			SCALE: ---	DRWN BY PAN
0~3	3~18	18~50	50~120	CHK'D BY FENG	
±0.12	±0.15	±0.3	±0.5	APPR BY ZHAN	

Pluggable Terminal Block 3.5MM	
THIRD ANGLE PROJECTION	RHTBYDBR-3.50-XXP-4-00

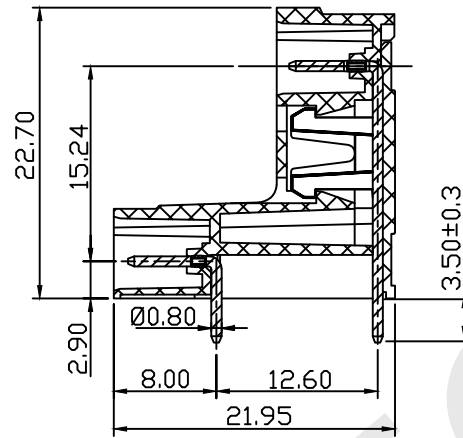
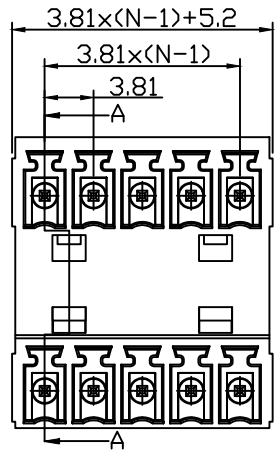

SECTION A-A

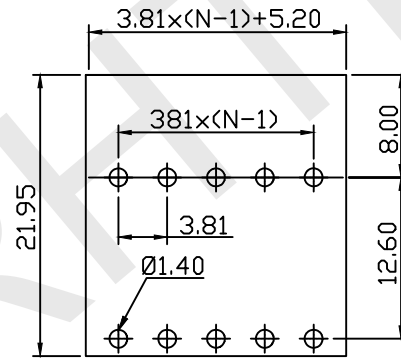
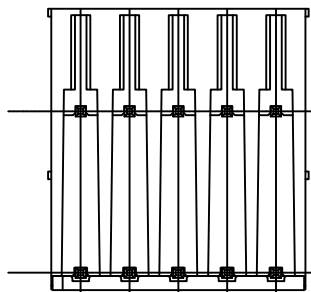

PCB LAYOUT

Material

Housing: PA66, UL94V-0

Pin header: Brass, Tin plated

Electrical

Rated voltage: 300V

Rated current: 8A

Contact Resistance: 20mΩ

Insulation resistance: 500MΩ/DC500V

Withstand voltage: A2000V/1min

Mechanical

Temp. Range: -40°C+105°C

Order Information

RHTBYDBR-3.81-XXP-4 00

Terminal Block

Pitch

No. of Pole

Color: 4-Green

Code: Product Code: 00~99

RHTECP NINGBO RHT ELECTRONIC CO.,LTD

UNITS:mm	SHEET SIZE: A4				SCALE:---	DRWN BY PAN
0~3	3~18	18~50	50~120	CHK'D BY FENG	THIRD ANGLE PROJECTION	
±0.12	±0.15	±0.3	±0.5	APPR BY ZHAN	RHTBYDBR-3.81-XXP-4-00	

Pluggable Terminal Block 3.5MM

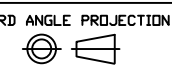

RHTBYDBR-3.81-XXP-4-00