

SECTION A-A

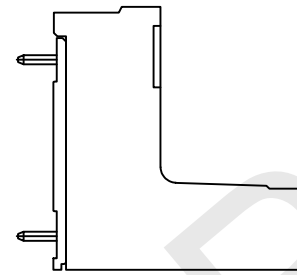

Material

Housing: PA66, UL94V-0

Pin header: Brass, Tin plated

Electrical

Rated voltage: 300V

Rated current: 8A

Contact Resistance: 20mΩ

Insulation resistance: 500MΩ/DC500V

Withstand voltage: AC2000V/1min

Mechanical

Temp. Range: -40°C ~ +105°C

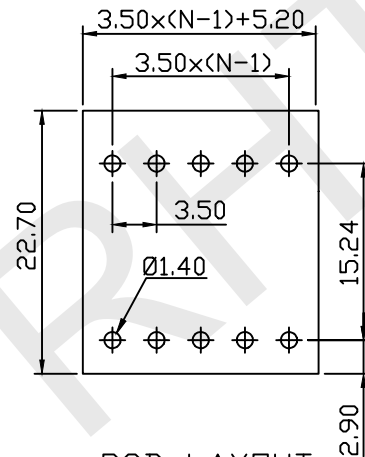
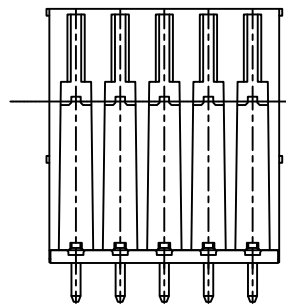

PCB LAYOUT

Order Information

RHTBYDBV-3.50-XXP-4 00

Terminal Block

Pitch

No. of Pole

Color: 4-Green

Product Code: 00~99

RHTECP NINGBO RHT ELECTRONIC CO.,LTD

UNITS:mm	SHEET SIZE: A4		SCALE:---	DRWN BY PAN
0~3	3~18	18~50	50~120	CHK'D BY FENG
±0.12	±0.15	±0.3	±0.5	APPR BY ZHAN

Pluggable Terminal Block 3.5MM

THIRD ANGLE PROJECTION

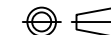

RHTBYDBV-3.50-XXP-4-00

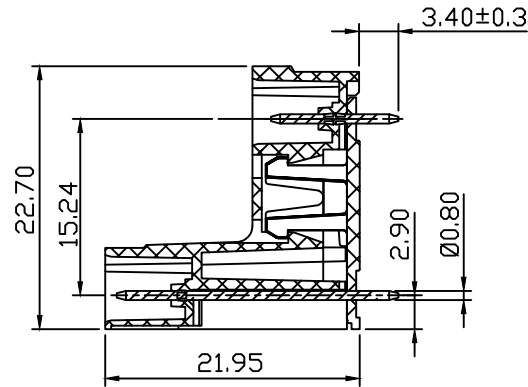
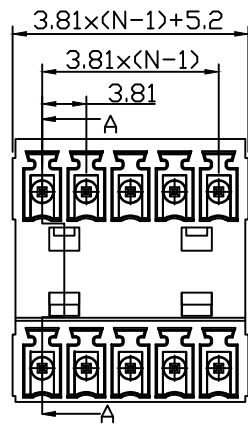

SECTION A-A

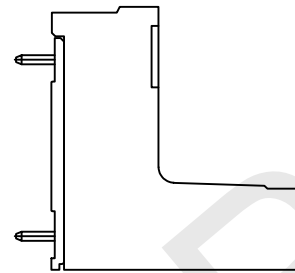

Material

Housing: PA66, UL94V-0

Pin header: Brass, Tin plated

Electrical

Rated voltage: 300V

Rated current: 8A

Contact Resistance: 20mΩ

Insulation resistance: 500MΩ/DC500V

Withstand voltage: AC2000V/1min

Mechanical

Temp. Range: -40°C ~ +105°C

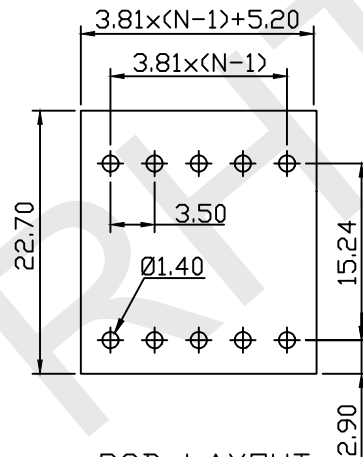
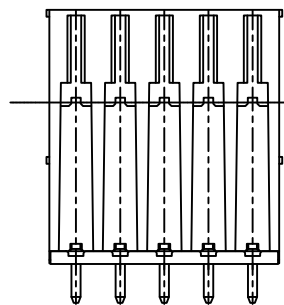

PCB LAYOUT

Order Information

RHTBYDBV-3.81-XXP-4 00

Terminal Block

Pitch

No. of Pole

Color: 4-Green

Product Code: 00~99

RHTECP NINGBO RHT ELECTRONIC CO.,LTD

UNITS:mm	SHEET SIZE: A4			SCALE:---	DRWN BY PAN
0~3	3~18	18~50	50~120	CHK'D BY FENG	
±0.12	±0.15	±0.3	±0.5	APPR BY ZHAN	

Pluggable Terminal Block 3.81MM

THIRD ANGLE PROJECTION

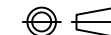

RHTBYDBV-3.81-XXP-4-00