

Recommended P.C.B Layout(Top Side)  
(PCB BOARD TOLERANCE±0.05)

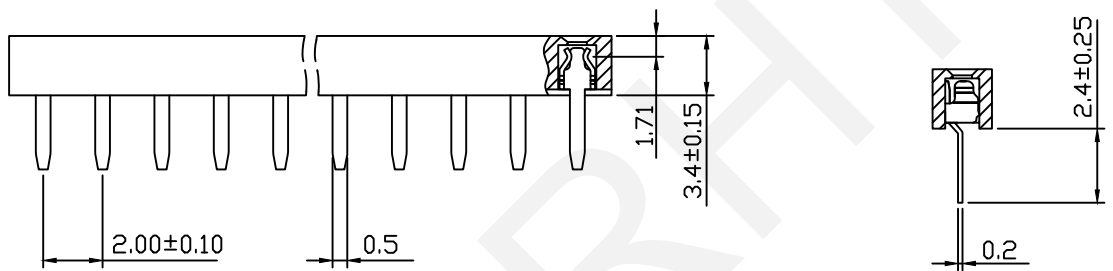

Material:  
Standard: PBT/PA6T  
Contact:Phosphor Bronze  
Plating: Au or Sn Over Ni  
Insulator: Polyester, UL94V-0

Electrical Characteristics:  
Rated Current: 1.5AMP  
Contact Resistance: 20mΩ Max  
Withstand Voltage: 500V AC/DC  
Insulator Resistance: 1000MΩ Min

Mechanical  
Operating Temperature: -40°C~+105°C  
Max.Processing Temp:230°C for 30-60 seconds  
(260°C for 10 seconds)

Order Information:  
RHTAY08B-3.4-1-XX-S-B  
Female Header Series  
08B:2.00mm  
Plastics Height:3.4mm  
Per Row:Single layer  
Pin: No.of Pins [1x40]  
Type: Straight Pin  
Material:A=PBT B=PA6T C=LCP

UNITS:mm	SHEET SIZE: A4				SCALE:---	DRWN BY PAN
0~3	3~18	18~50	50~120	CHK'D BY FENG	2.0x3.4mm Female Header Single Layer, Straight Pin, 1xN Pin	
±0.12	±0.15	±0.3	±0.5	APPR BY ZHAN	THIRD ANGLE PROJECTION	RHTAY08B-3.4-1-XX-S-B

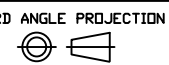

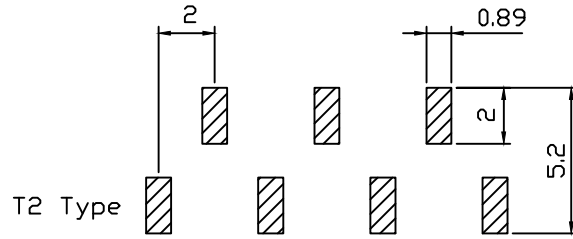
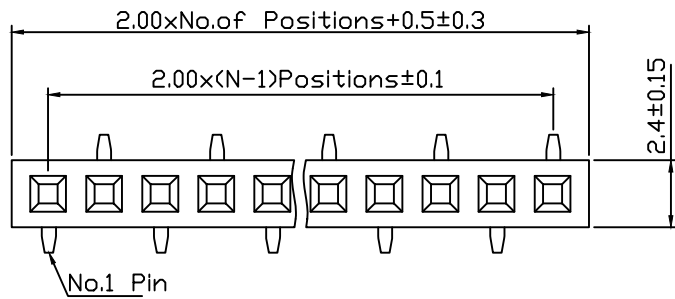

Material:  
 Standard: PBT/PA6T  
 Contact: Phosphor Bronze  
 Plating: Au or Sn Over 40n"  
 Insulator: Polyester, UL94V-0  
 Electrical Characteristics:  
 Rated Current: 1.5AMP  
 Contact Resistance: 20mΩ Max  
 Withstand Voltage: 500V AC/DC  
 Insulator Resistance: 1000MΩ Min  
 Mechanical  
 Operating Temperature: -40°C~+105°C  
 Max. Processing Temp: 230°C for 30-60 seconds  
 (260°C for 10 seconds)

Recommended P.C.B Layout (Top Side)  
 (PCB BOARD TOLERANCE ±0.05)

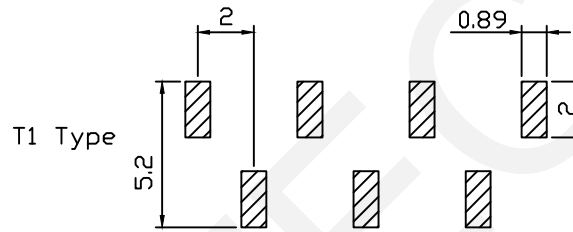
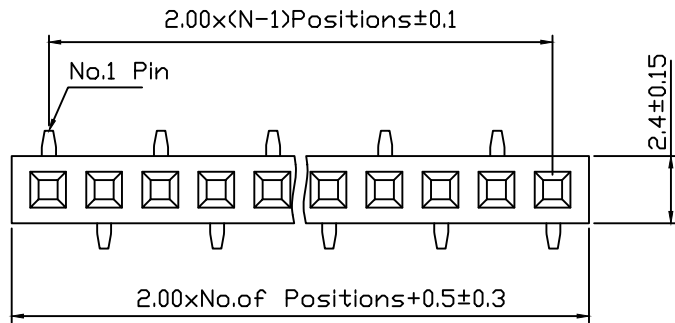

Order Information:

RHTAY08B-3.4-1-XX-T2-L1xL2-N-B-R

Female Header Series  
 08B: 2.00mm  
 Plastics Height: 3.4mm  
 Per Row: Single layer  
 Pin: No. of Pins [1x40]  
 SMT Pin: T1 Type, T2 Type  
 Size: L1xL2  
 Post: W=With Post N=W/0 Post  
 Material: A=PBT B=PA6T C=LCP  
 Packing:  
 0=PE Bag A=Tray T=Tube  
 P=Tube+Cap R=Reel+Cap

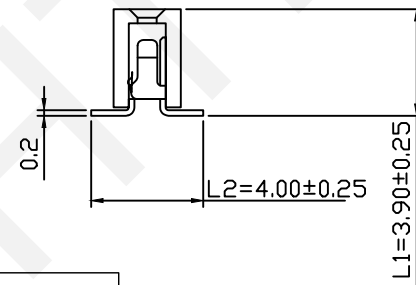
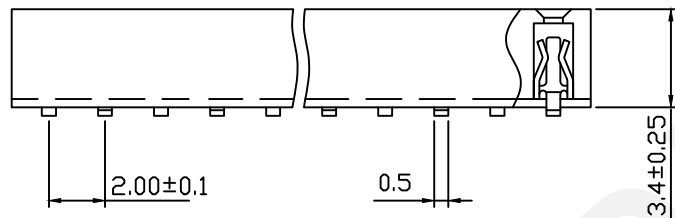

Dimension Antitheses List (mm)			
ITEM	L1	L2	Plastic Height
Standard	3.90	4.00	3.40
Nonstandard	---	---	---

UNITS:mm	SHEET SIZE: A4	SCALE: ---	DRWN BY PAN
0~3	3~18	18~50	50~120
±0.12	±0.15	±0.3	±0.5
CHK'D BY FENG		APPR BY ZHAN	

2.0x3.4mm Female Header Single Layer, SMT Pin, 1xN Pin	
THIRD ANGLE PROJECTION 	RHTAY08B-3.4-1-XX-T2-L1xL2-N-B-R



NINGBO RHT ELECTRONIC CO.,LTD

1 2 3 4 5 6 7 8 9

A

B

C

D

E

F

A

B

C

D

E

F

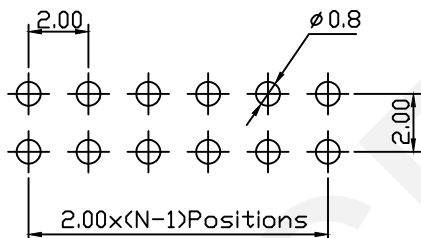
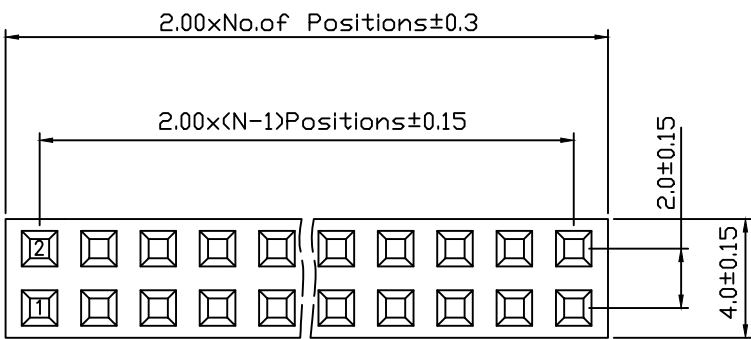

Recommended P.C.B Layout(Top Side)  
(PCB BOARD TOLERANCE±0.05)

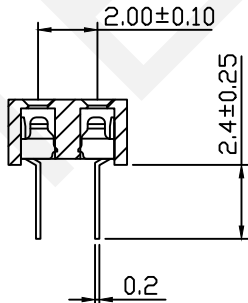
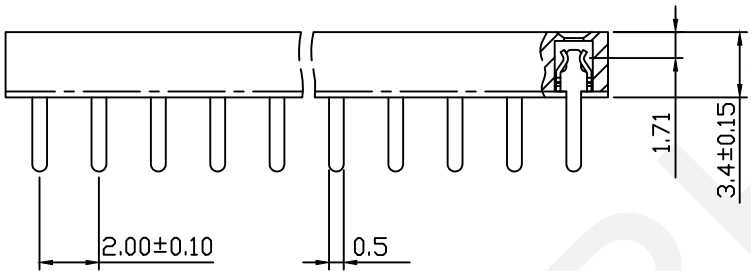

Material:  
Standard: PBT/PA6T  
Contact: Phosphor Bronze  
Plating: Au or Sn Over Ni  
Insulator: Polyester, UL94V-0

Electrical Characteristics:  
Rated Current: 1.5AMP  
Contact Resistance: 20mΩ Max  
Withstand Voltage: 500V AC/DC  
Insulator Resistance: 1000MΩ Min

Mechanical  
Operating Temperature: -40°C~+105°C  
Max. Processing Temp: 230°C for 30-60 seconds  
(260°C for 10 seconds)

Order Information:  
RHTAY08B-3.4-2-XX-S-B  
Female Header Series  
08B: 2.00mm  
Plastics Height: 3.4mm  
Per Row: Double layer  
Pin: No. of Pins [2x40]  
Type: Straight Pin  
Material: A=PBT B=PA6T C=LCP



NINGBO RHT ELECTRONIC CO.,LTD

UNITS:mm	SHEET SIZE: A4	SCALE:---	DRWN BY PAN
0~3	3~18	18~50	50~120
±0.12	±0.15	±0.3	±0.5

CHK'D BY FENG  
APPR BY ZHAN

2.0x3.4mm Female Header  
Double Layer, Straight Pin, 2xN Pin  
THIRD ANGLE PROJECTION  
RHTAY08B-3.4-2-XX-S-B

1 2 3 4 5 6 7 8 9

G

G

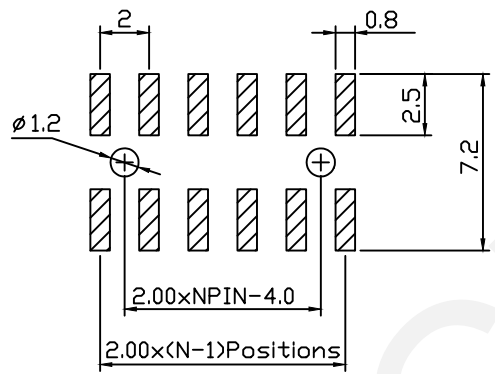
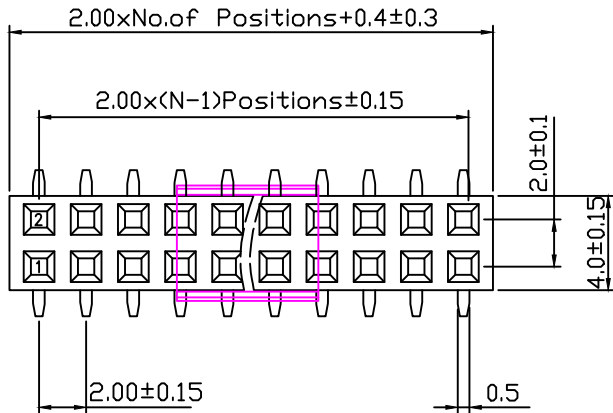

Recommended P.C.B Layout(Top Side)  
(PCB BOARD TOLERANCE±0.05)

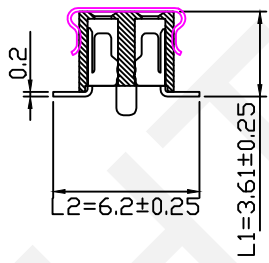
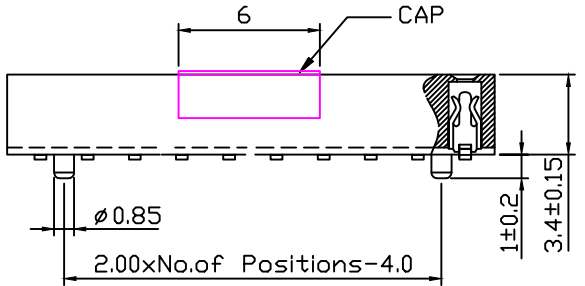

T3=With Post

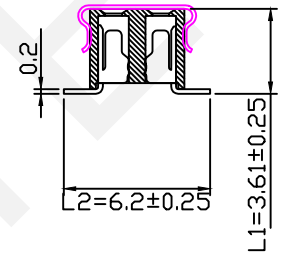

Without Post

Dimension Antitheses List (mm)			
ITEM	L1	L2	Plastic Height
Standard	3.61	6.20	3.40
Nonstandard	---	---	---

Material:  
Standard: PA6T  
Contact:Brass  
Plating: Au or Sn Over Ni  
Insulator: Polyester, UL94V-0  
Electrical Characteristics:  
Rated Current: 1.5AMP  
Contact Resistance: 20mΩ Max  
Withstand Voltage: 500V AC/DC  
Insulator Resistance: 1000MΩ Min  
Mechanical  
Operating Temperature: -40°C~+105°C  
Max.Processing Temp: 230°C for 30-60 seconds  
(260°C for 10 seconds)

Order Information:  
RHTAY08B-3.4-2-XX-T-L1xL2-B-R  
Female Header Series  
08B:2.00mm  
Plastics Height:3.4mm  
Per Row:Double layer  
Pin: No.of Pins [2x40]  
SMT:T=Without Post,T3=With Post  
Size:L1xL2 \_\_\_\_\_  
Material:A=PBT B=PA6T C=LCP \_\_\_\_\_  
Packing: \_\_\_\_\_  
0=PE Bag A=Tray T=Tube  
P=Tube+Cap R=Reel+Cap

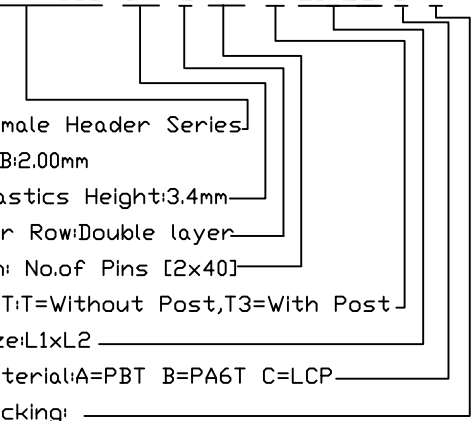

NINGBO RHT ELECTRONIC CO.,LTD

UNITS:mm	SHEET SIZE: A4		SCALE:---	DRWN BY PAN
0~3	3~18	18~50	50~120	CHK'D BY FENG
±0.12	±0.15	±0.3	±0.5	APPR BY ZHAN

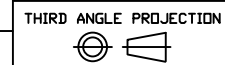

RHTAY08B-3.4-2-XX-T-L1xL2-B-R

2.0x3.4mm Female Header  
Double Layer,SMT Pin, 2xN Pin