

RoHS Compliance

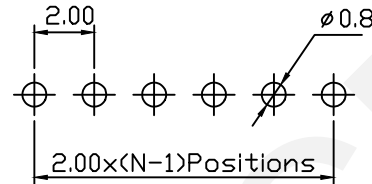

Recommended P.C.B Layout(Top Side)  
(PCB BOARD TOLERANCE±0.05)

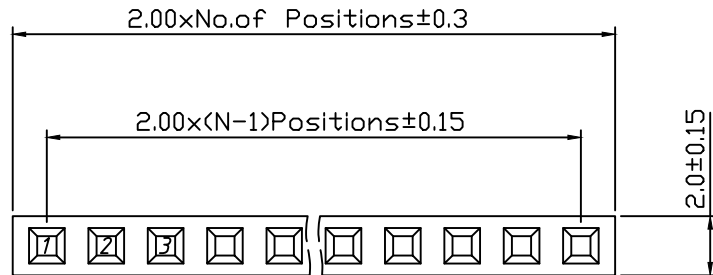
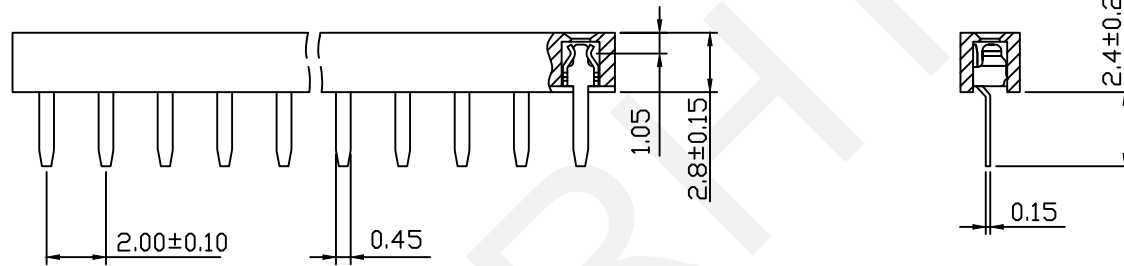

Material:  
Standard:PBT/PA6T  
Contact:Phosphor Bronze  
Plating:Au Or Sn Over Ni  
Insulator:Polyester,UL94V-0

Electrical Characteristics:  
Rated Current: 1.5AMP  
Contact Resistance: 20mΩ Max  
Withstand Voltage: 500V AC/DC  
Insulator Resistance: 1000MΩ Min

Mechanical  
Operating Temperature:-40°C~+105°C  
Max.Processing Temp:230°C For 30-60  
Seconds (260°C For 10 Seconds)

Order Information:  
RHTAY08B-2.8-1-XX-S-B  
Female Header Series  
08B:2.00mm  
Plastics Height:2.8mm  
Per Row:Single Layer  
Pin: No.of Pins (1x40)  
Type:Straight Pin  
Material:A=PBT B=PA6T C=LCP

**RHTECP** NINGBO RHT ELECTRONIC CO.,LTD

UNITS:mm	SHEET SIZE: A4				SCALE:---	DRWN BY PAN
0~3	3~18	18~50	50~120	CHK'D BY FENG	2.0x2.8mm Female Header Single Layer, Straight Pin, 1xN Pin	
±0.12	±0.15	±0.3	±0.5	APPR BY ZHAN	THIRD ANGLE PROJECTION	RHTAY08B-2.8-1-XX-S-B

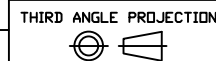

RoHS Compliance

Recommended P.C.B Layout(Top Side)  
(PCB BOARD TOLERANCE±0.05)

Material:  
Standard:PA6T  
Contact:Brass  
Plating:Au Or Sn Over Ni  
Insulator:Polyester,UL94V-0  
Electrical Characteristics:  
Rated Current: 1.5AMP  
Contact Resistance: 20mΩ Max  
Withstand Voltage: 500V AC/DC  
Insulator Resistance: 1000MΩ Min  
Mechanical  
Operating Temperature:-40℃~+105℃  
Max.Processing Temp:230℃ For 30-60  
Seconds (260℃ For 10 Seconds)

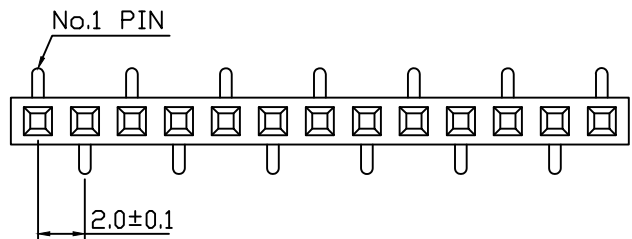

T1 Type

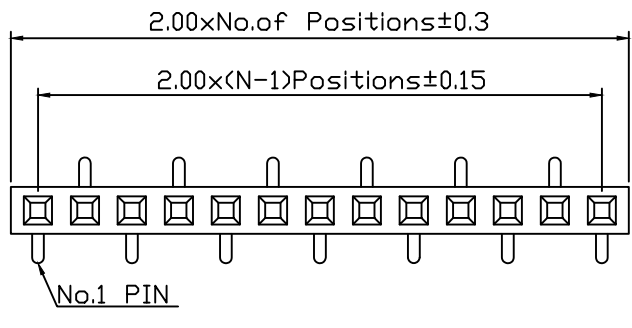
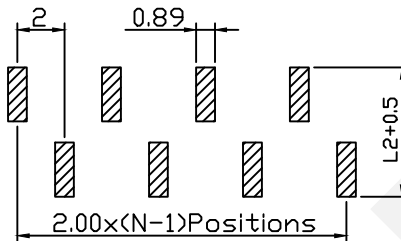

T2 Type

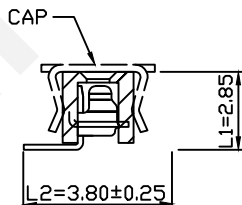
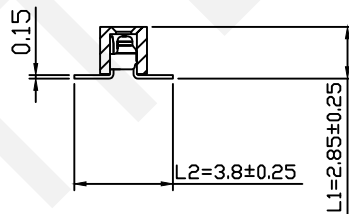
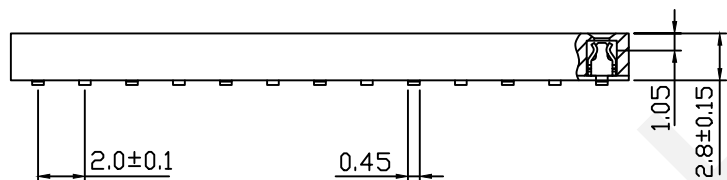
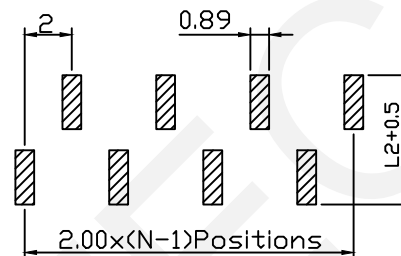

Order Information:

RHTAY08B-2.8-1-XX-T1-L1xL2-N-B-R

Female Header Series-  
08B:2.00mm  
Plastics Height:2.8mm  
Per Row:Single Layer  
Pin: No.of Pins (1x40)  
SMT Pin:T1 Type,T2 Type  
Size:L1xL2  
Post:W=With Post N=W/0 Post  
Material:A=PBT B=PA6T C=LCP  
Packing:  
A=Tray T=Tube M=Reel+Mylar  
P=Tube+Cap R=Reel+Cap

Dimension Antitheses List (mm)

ITEM	L1	L2	Plastic Height
Standard	2.85	3.80	2.80
Nonstandard	---	---	---

UNITS:mm	SHEET SIZE: A4	SCALE:---	DRWN BY PAN
0~3	3~18	18~50	50~120
±0.12	±0.15	±0.3	±0.5
CHK'D BY FENG		APPR BY ZHAN	

2.00mm Female Header Single Layer,SMT Pin, 1xN Pin	
THIRD ANGLE PROJECTION 	RHTAY08B-2.8-1-XX-T1-L1xL2-N-B-R



NINGBO RHT ELECTRONIC CO.,LTD

RoHS Compliance

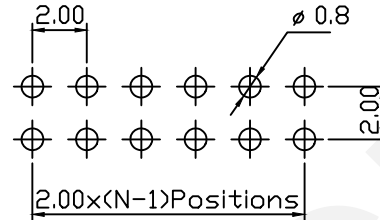
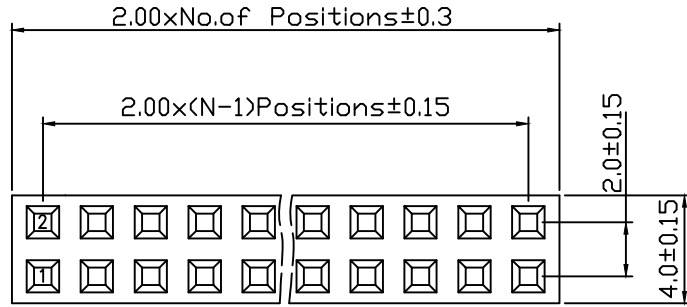

Recommended P.C.B Layout(Top Side)  
(PCB BOARD TOLERANCE±0.05)

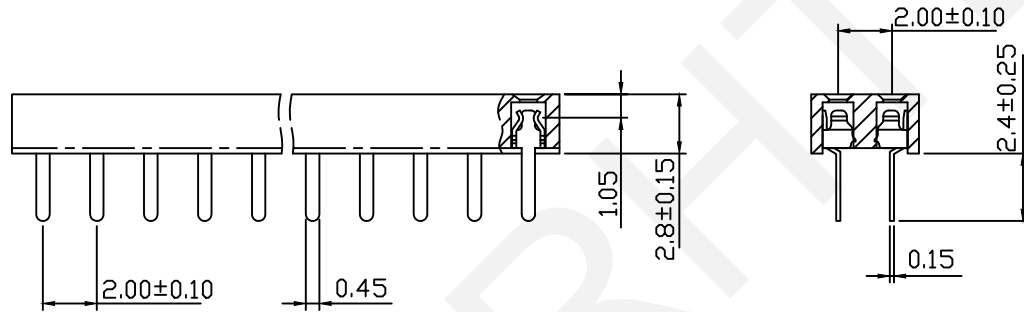

Material:  
Standard:PBT/PA6T  
Contact:Phosphor Bronze  
Plating:Au Or Sn Over Ni  
Insulator:Polyester,UL94V-0

Electrical Characteristics:  
Rated Current: 1.5AMP  
Contact Resistance: 20mΩ Max  
Withstand Voltage: 500V AC/DC  
Insulator Resistance: 1000MΩ Min

Mechanical  
Operating Temperature:-40°C~+105°C  
Max.Processing Temp:230°C For 30-60  
Seconds (260°C For 10 Seconds)

Order Information:  
RHTAY08B-2.8-2-XX-S-B  
Female Header Series  
08B:2.00mm  
Plastics Height:2.8mm  
Per Row:Double Layer  
Pin: No.of Pins (02~80)  
Type:Straight Pin  
Material:A=PBT B=PA6T C=LCP

NINGBO RHT ELECTRONIC CO.,LTD

UNITS:mm	SHEET SIZE: A4	SCALE:---	DRWN BY PAN
0~3	3~18	18~50	50~120
±0.12	±0.15	±0.3	±0.5
			CHK'D BY FENG
			APPR BY ZHAN

2.0x2.8mm Female Header  
Double Layer,Straight Pin, 2xN Pin

THIRD ANGLE PROJECTION

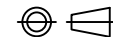

RHTAY08B-2.8-2-XX-S-B

RoHS Compliance

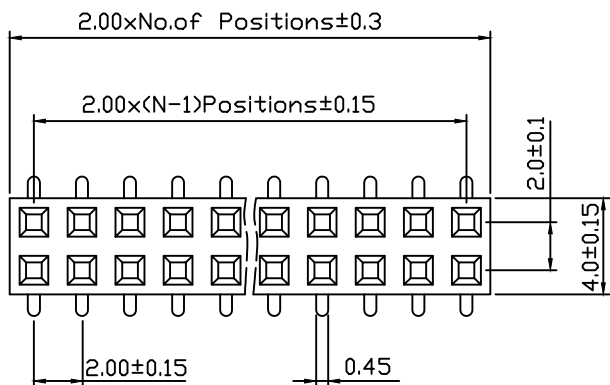

Recommended P.C.B Layout(Top Side)  
(PCB BOARD TOLERANCE±0.05)

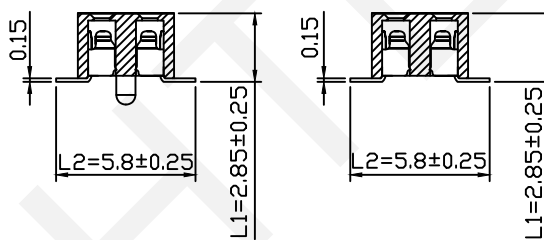
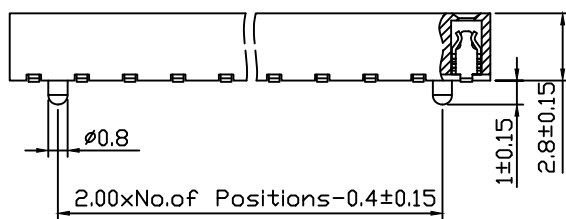
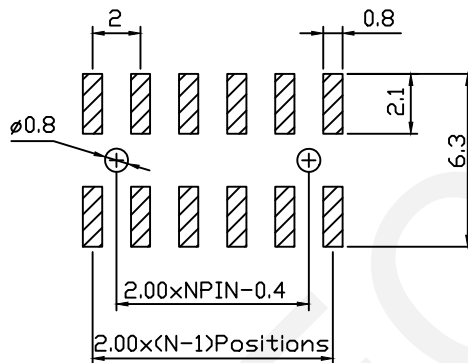

T3=With Post

T=Without Post

Dimension Antitheses List (mm)

ITEM	L1	L2	Plastic Height
Standard	2.85	5.80	2.80
Nonstandard	---	---	---

Material:

Standard:PA6T

Contact:Phosphor Bronze

Plating:Au Or Sn Over Ni

Insulator:Polyester,UL94V-0

Electrical Characteristics:

Rated Current: 1.5AMP

Contact Resistance: 20mΩ Max

Withstand Voltage: 500V AC/DC

Insulator Resistance: 1000MΩ Min

Mechanical

Operating Temperature:-40℃~+105℃

Max.Processing Temp:230℃ For 30-60

Seconds (260℃ For 10 Seconds)

Order Information:

RHTAY08B-2.8-2-XX-T-L1xL2-B-R

Female Header Series-

08B:2.00mm

Plastics Height:2.8mm

Per Row:Double Layer

Pin: No.of Pins (02~80)

SMT:T=Without Post

T3=With Post

Size:L1xL2

Material:A=PBT B=PA6T C=LCP

Packing:

A=Tray T=Tube M=Reel+Mylar

P=Tube+Cap R=Reel+Cap

NINGBO RHT ELECTRONIC CO.,LTD

UNITS:mm	SHEET SIZE: A4			SCALE:---	DRWN BY PAN
0~3	3~18	18~50	50~120	CHK'D BY FENG	THIRD ANGLE PROJECTION 
±0.12	±0.15	±0.3	±0.5	APPR BY ZHAN	

2.00 Female Header  
Double Layer,SMT Pin, 2xN Pin  
RHTAY08B-2.8-2-XX-T-L1xL2-B-R