

1 2 3 4 5 6 7 8 9

A

A

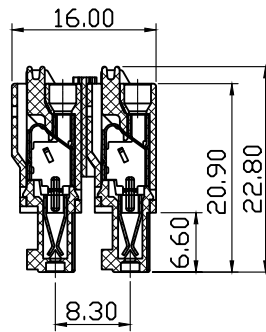
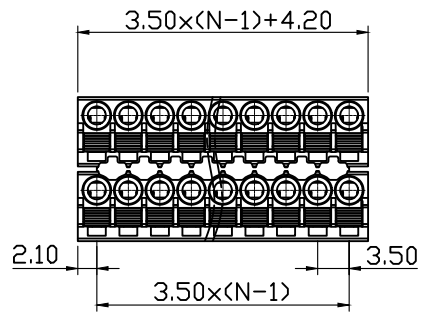

Material
 Housing:PA66,UL94V-0
 Shrapnel:Stainless steel
 Clamp:Phosphor bronze, Tin plated

Electrical
 Rated voltage:300V
 Rated current:8A
 Contact Resistance:20 mΩ
 Withstand voltage:AC2000V/1Min
 Insulation resistance:500MΩ/DC500V
 Wire Range:24~16AWG 10mm²

Mechanical
 Temp.Range:-40°C~+105°C
 Strip length:9-10mm

Order Information

RHTBYMCC-3.50-XXP-4 00

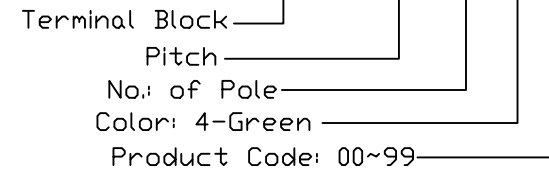

B

B

C

C

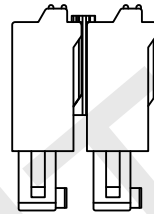
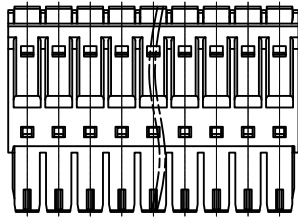

D

D

E

E

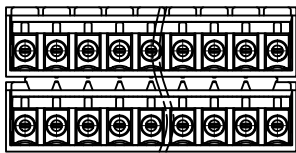

F

F

G

G

RHTECP NINGBO RHT ELECTRONIC CO.,LTD

UNITS:mm	SHEET SIZE: A4				SCALE:---	DRWN BY PAN
0~3	3~18	18~50	50~120	CHK'D BY FENG	Pluggable Terminal Block 3.50MM	
±0.12	±0.15	±0.3	±0.5	APPR BY ZHAN	THIRD ANGLE PROJECTION	RHTBYMCC-3.50-XXP-4-00

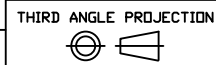

1 2 3 4 5 6 7 8 9