

RoHS Compliance

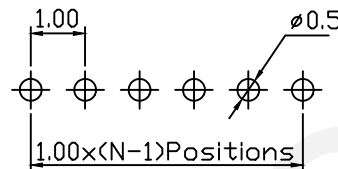

Recommended P.C.B Layout(Top Side)
(PCB BOARD TOLERANCE±0.05)

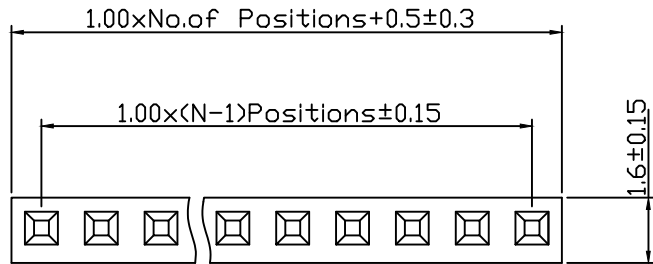
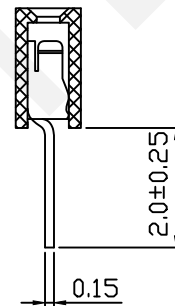
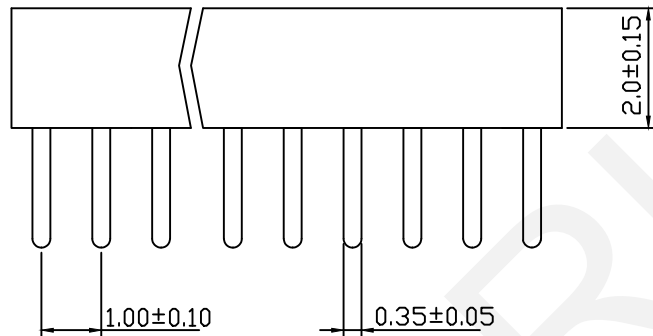

Material:
Standard:PA6T/LCP
Contact:Phosphor Bronze
Plating:Au Or Sn Over Ni
Insulator:Polyester,UL94V-0

Electrical Characteristics:
Rated Current: 0.75AMP
Contact Resistance: 30mΩ Max
Withstand Voltage: 500V AC/DC
Insulator Resistance: 1000MΩ Min

Mechanical
Operating Temperature:-40℃~+105℃
Max.Processing Temp:240℃ For 30-60
Seconds (260℃ For 10 Seconds)

Order Information:

RHTAY08F-2.0-1-XX-S-B

Female Header Series

08F:1.00mm

Plastics Height:2.0mm

Per Row:Single Layer

Pin: No.of Pins (1x40)

Type:Straight Pin

Material: B=PA6T C=LCP

NINGBO RHT ELECTRONIC CO.,LTD

UNITS:mm	SHEET SIZE: A4	SCALE:---	DRWN BY PAN
0~3	3~18	18~50	50~120
±0.12	±0.15	±0.3	±0.5

CHK'D BY FENG
APPR BY ZHAN

1.0x2.0mm Female Header
Single Layer,Straight Pin, 1xN Pin
THIRD ANGLE PROJECTION
 RHTAY08F-2.0-1-XX-S-B

RoHS Compliance

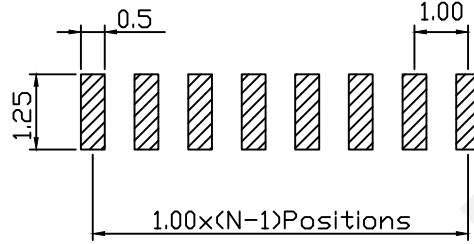
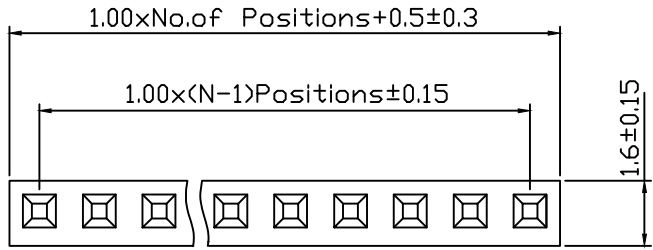

Recommended P.C.B Layout (Top Side)
(PCB BOARD TOLERANCE±0.05)

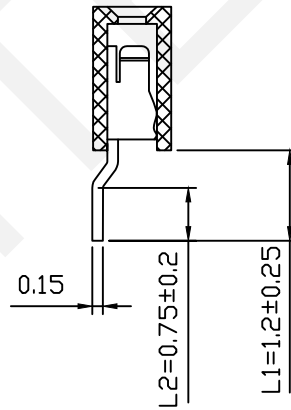
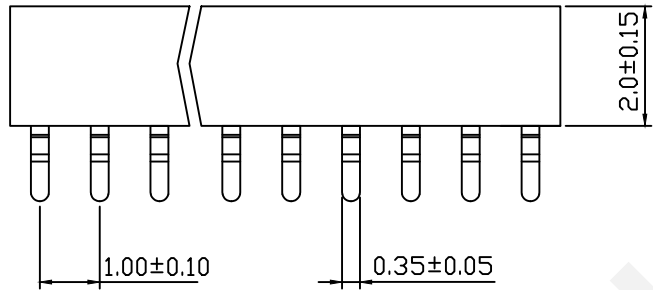

Dimension Antitheses List (mm)			
ITEM	L1	L2	Plastic Height
Standard	1.20	0.75	2.00
Nonstandard	---	---	---

Material:
Standard:PA6T/LCP
Contact:Phosphor Bronze
Plating:Au Or Sn Over Ni
Insulator:Polyester,UL94V-0
Electrical Characteristics:
Rated Current: 0.75AMP
Contact Resistance: 30mΩ Max
Withstand Voltage: 500V AC/DC
Insulator Resistance: 1000MΩ Min
Mechanical
Operating Temperature:-40℃~+105℃
Max.Processing Temp:240℃ For 30-60
Seconds (260℃ For 10 Seconds)

Order Information:
RHTAY08F-2.0-1-XX-RM-L1xL2-N-B-R

Female Header Series-
08F:1.00mm
Plastics Height:2.0mm
Per Row:Single Layer
Pin: No.of Pins (1x40)
SMT Pin: Horizontal SMT
Size:L1xL2
Post:W=With Post N=W/0 Post
Material:B=PA6T C=LCP
Packing:
A=Tray T=Tube M=Reel+Mylar
P=Tube+Cap R=Reel+Cap

NINGBO RHT ELECTRONIC CO.,LTD

UNITS:mm	SHEET SIZE: A4	SCALE:---	DRWN BY PAN
0~3	3~18	18~50	50~120
±0.12	±0.15	±0.3	±0.5

CHK'D BY FENG
APPR BY ZHAN

1.0x2.0mm Female Header
Single Layer,Horizontal SMT, 1xN Pin
THIRD ANGLE PROJECTION
 RHTAY08F-2.0-1-XX-RM-L1xL2-N-B-R

RoHS Compliance

Recommended P.C.B Layout (Top Side)
(PCB BOARD TOLERANCE ±0.05)

Material:

Standard: PA6T/LCP

Contact: Phosphor Bronze

Plating: Au Or Sn Over Ni

Insulator: Polyester, UL94V-0

Electrical Characteristics:

Rated Current: 0.75AMP

Contact Resistance: 30mΩ Max

Withstand Voltage: 500V AC/DC

Insulator Resistance: 1000MΩ Min

Mechanical

Operating Temperature: -40°C ~ +105°C

Max. Processing Temp: 240°C For 30-60

Seconds (260°C For 10 Seconds)

Order Information:

RHTAY08F-2.0-1-XX-T1-L1xL2-N-B-R

Female Header Series-

08F: 1.00mm

Plastics Height: 2.0mm

Per Row: Single Layer

Pin: No. of Pins (1x40)

SMT Pin: T1 Type T2 Type

Size: L1xL2

Post: W=With Post N=W/0 Post

Material: B=PA6T C=LCP

Packing:

A=Tray T=Tube M=Reel+Mylar

P=Tube+Cap R=Reel+Cap

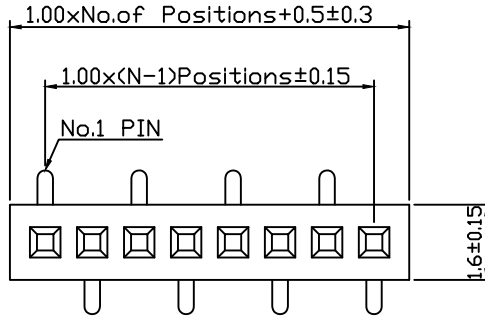

T1 Type

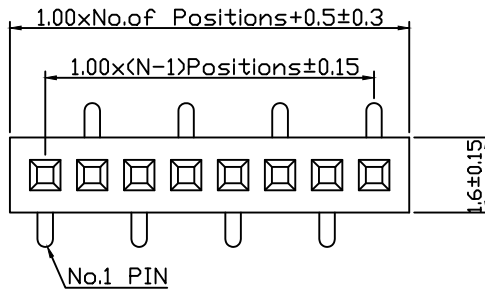
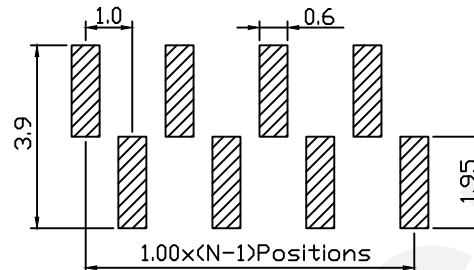

T2 Type

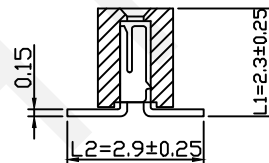
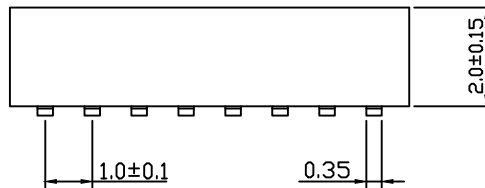
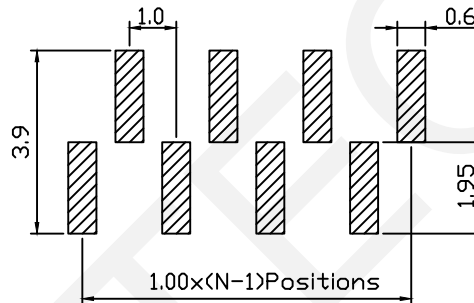

Dimension Antitheses List (mm)			
ITEM	L1	L2	Plastic Height
Standard	2.30	2.90	2.00
Nonstandard	---	---	---

UNITS: mm	SHEET SIZE: A4	SCALE: ---	DRWN BY PAN
0~3	3~18	18~50	50~120
±0.12	±0.15	±0.3	±0.5
CHK'D BY FENG		APPR BY ZHAN	

1.0mm Female Header Single Layer, SMT Pin, 1xN Pin	
THIRD ANGLE PROJECTION	RHTAY08F-2.0-1-XX-T1-L1xL2-N-B-R



NINGBO RHT ELECTRONIC CO., LTD

RoHS Compliance

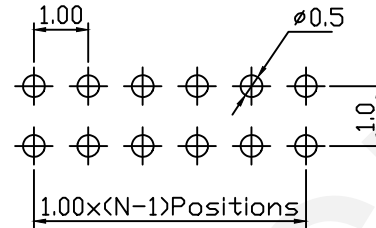
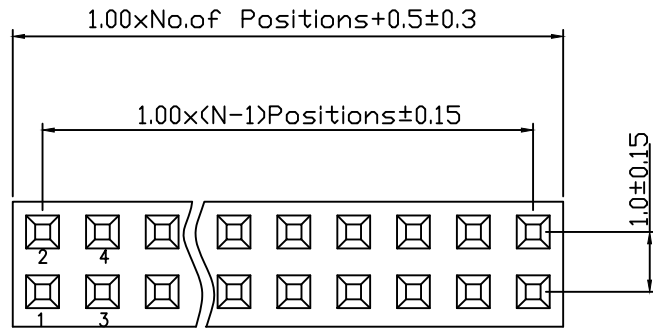

Recommended P.C.B Layout(Top Side)
(PCB BOARD TOLERANCE±0.05)

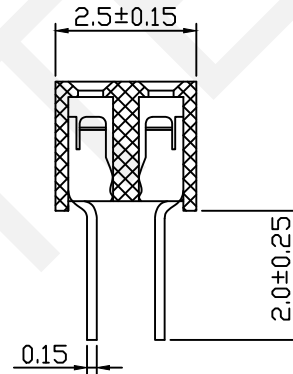
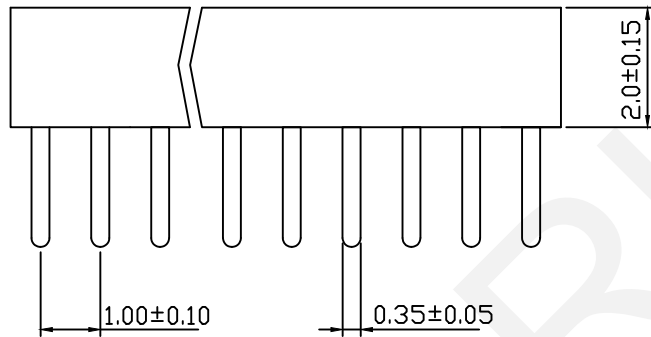

Material:
Standard:PA6T/LCP
Contact:Phosphor Bronze
Plating:Au Or Sn Over Ni
Insulator:Polyester,UL94V-0

Electrical Characteristics:
Rated Current: 0.75AMP
Contact Resistance: 30mΩ Max
Withstand Voltage: 500V AC/DC
Insulator Resistance: 1000MΩ Min

Mechanical
Operating Temperature:-40°C~+105°C
Max.Processing Temp:230°C For 30-60
Seconds (260°C For 10 Seconds)

Order Information:

RHTAY08F-2.0-2-XX-S-B

Female Header Series

08F:1.00mm

Plastics Height:2.0mm

Per Row:Double Layer

Pin: No.of Pins (02~80)

Type:Straight Pin

Material:B=PA6T C=LCP

 NINGBO RHT ELECTRONIC CO.,LTD

UNITS:mm	SHEET SIZE: A4	SCALE:---	DRWN BY PAN
0~3	3~18	18~50	50~120
±0.12	±0.15	±0.3	±0.5

CHK'D BY FENG
APPR BY ZHAN

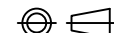
1.0x2.0mm Female Header
Double Layer,Straight Pin, 2xN Pin
THIRD ANGLE PROJECTION
 RHTAY08F-2.0-2-XX-S-B

RoHS Compliance

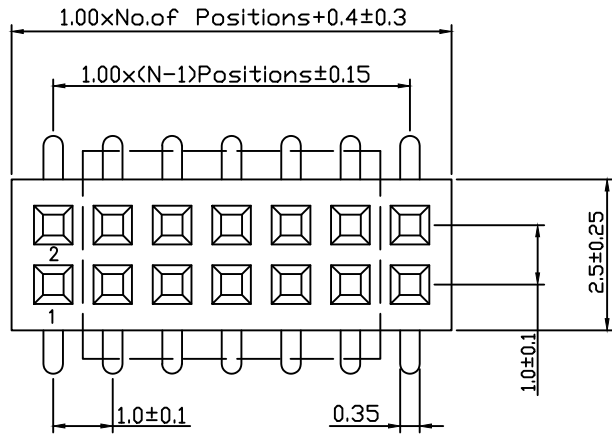

Recommended P.C.B Layout(Top Side)
(PCB BOARD TOLERANCE±0.05)

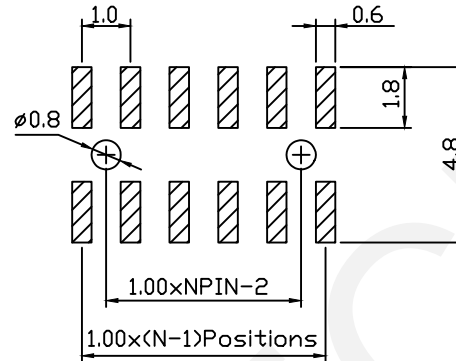

Material:

Standard:PA6T/LCP

Contact:Phosphor Bronze

Plating:Au Or Sn Over Ni

Insulator:Polyester,UL94V-0

Electrical Characteristics:

Rated Current: 0.75AMP

Contact Resistance: 30mΩ Max

Withstand Voltage: 500V AC/DC

Insulator Resistance: 1000MΩ Min

Mechanical

Operating Temperature:-40℃~+105℃

Max.Processing Temp:230℃ For 30-60

Seconds (260℃ For 10 Seconds)

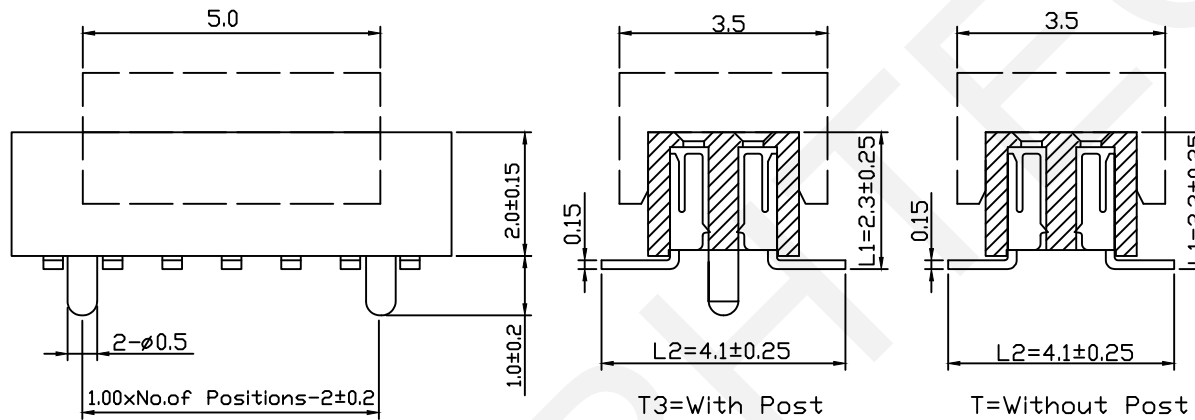

Dimension Antitheses List (mm)			
ITEM	L1	L2	Plastic Height
Standard	2.30	4.10	2.00
Nonstandard	---	---	---

Order Information:

RHTAY08F-2.0-2-XX-T-L1xL2-B-R

Female Header Series-

08F:1.00mm

Plastics Height:2.0mm

Per Row:Double Layer

Pin: No.of Pins (02~80)

SMT:T=Without Post

T3=With Post

Size:L1xL2

Material:B=PA6T C=LCP

Packing:

A=Tray T=Tube M=Reel+Mylar

P=Tube+Cap R=Reel+Cap

NINGBO RHT ELECTRONIC CO.,LTD

UNITS:mm	SHEET SIZE: A4	SCALE:---	DRWN BY PAN
0~3	3~18	18~50	50~120
±0.12	±0.15	±0.3	±0.5

CHK'D BY FENG
APPR BY ZHAN

1.00 Female Header
Double Layer,SMT Pin, 2xN Pin
THIRD ANGLE PROJECTION
 RHTAY08F-2.0-2-XX-T-L1xL2-B-R