

SECTION A-A

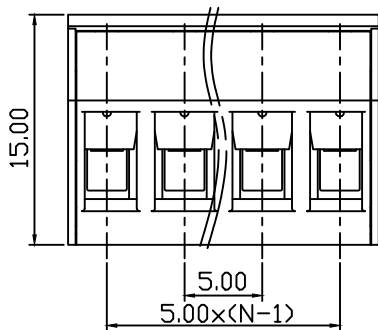

Material
 Housing:PA66,UL94V-0
 Cage:Brass, Nickel plated
 Clamp:Phosphor Bronze, Nickel plated
 Screw:M3.0 steel,Zn plated

Electrical
 Rated voltage: 300V
 Rated current:15A
 Contact Resistance: 20 mΩ
 Insulation resistance:500MΩ/DC500V
 Withstand voltage:AC2000V/1min
 Wire Range:28~14AWG/2.5mm²

Mechanical
 Temp.Range:-40℃~+ 105℃
 Strip length:7~8mm
 Torque:5.1kgf-cm(0.5Nm/4.43Lbin)

Order Information

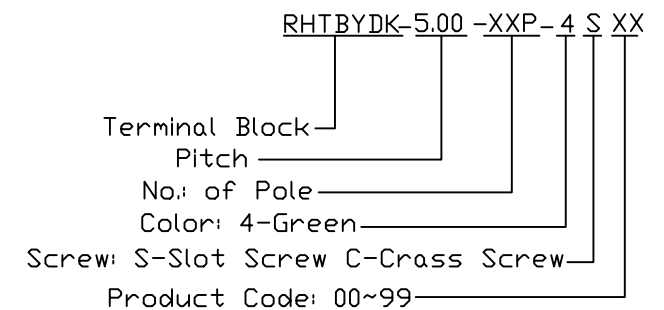

RHTECP NINGBO RHT ELECTRONIC CO.,LTD

UNITS:mm	SHEET SIZE: A4			SCALE:---	DRWN BY PAN
0~3	3~18	18~50	50~120	CHK'D BY FENG	
±0.12	±0.15	±0.3	±0.5	APPR BY ZHAN	

Plug-in TERM BLOCK 5.00MM
 THIRD ANGLE PROJECTION
 RHTBYDK-5.00-XXP-4X

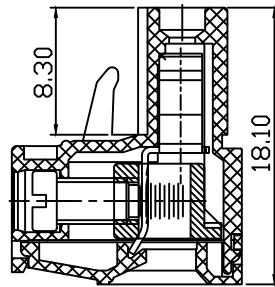
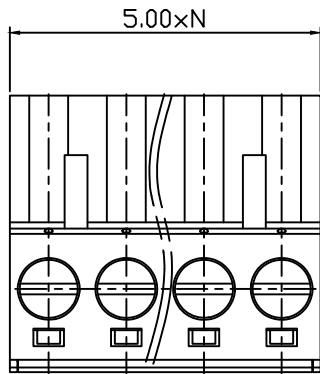

SECTION A-A

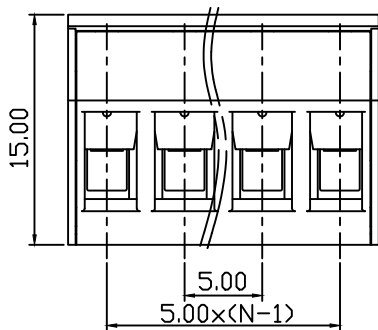

Material
 Housing:PA66,UL94V-0
 Cage:Iron, Nickel plated
 Clamp:Phosphor Bronze, Nickel plated
 Screw:M3.0 steel,Zn plated

Electrical
 Rated voltage: 300V
 Rated current:15A
 Contact Resistance: 20 mΩ
 Insulation resistance:500MΩ/DC500V
 Withstand voltage:AC2000V/1min
 Wire Range:28~14AWG/2.5mm²

Mechanical
 Temp.Range:-40℃~+ 105℃
 Strip length:7~8mm
 Torque:5.1kgf-cm(0.5Nm/4.43Lbin)

Order Information

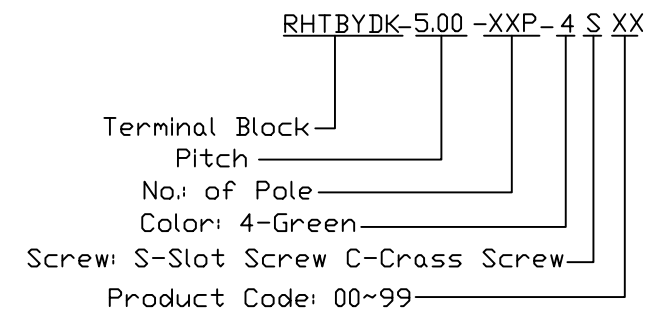

RHTECP NINGBO RHT ELECTRONIC CO.,LTD

UNITS:mm	SHEET SIZE: A4			SCALE:---	DRWN BY PAN
0~3	3~18	18~50	50~120	CHK'D BY FENG	
±0.12	±0.15	±0.3	±0.5	APPR BY ZHAN	

Plug-in TERM BLOCK 5.00MM(Iron)
 THIRD ANGLE PROJECTION
 RHTBYDK-5.00-XXP-4X

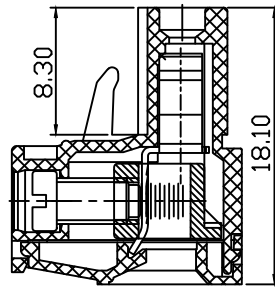
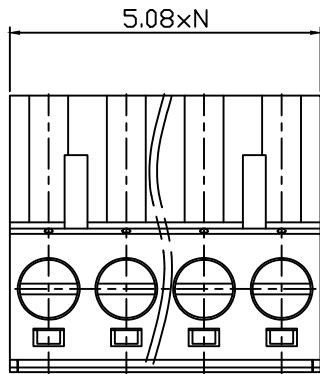

SECTION A-A

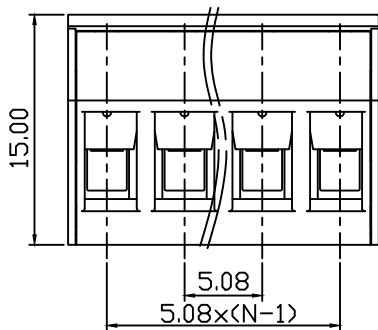

Material
 Housing:PA66,UL94V-0
 Cage:Brass Nickel plated
 Clamp:Phosphor Bronze, Nickel plated
 Screw:M3.0 steel,Zn plated

Electrical
 Rated voltage: 300V
 Rated current:15A
 Contact Resistance: 20 mΩ
 Insulation resistance:500MΩ/DC500V
 Withstand voltage:AC2000V/1min
 Wire Range:28~14AWG/2.5mm²

Mechanical
 Temp.Range:-40℃~+ 105℃
 Strip length:7~8mm
 Torque:5.1kgf-cm(0.5Nm/4.43Lbin)

Order Information

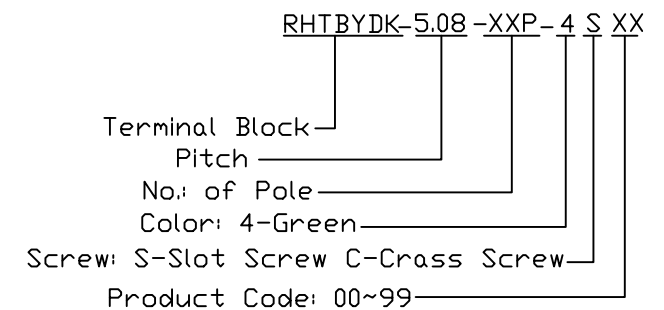

RHTECP NINGBO RHT ELECTRONIC CO.,LTD

UNITS:mm	SHEET SIZE: A4			SCALE:---	DRWN BY PAN
0~3	3~18	18~50	50~120	CHK'D BY FENG	
±0.12	±0.15	±0.3	±0.5	APPR BY ZHAN	

Plug-in TERM BLOCK 5.08MM
 THIRD ANGLE PROJECTION
 RHTBYDK-5.08-XXP-4X

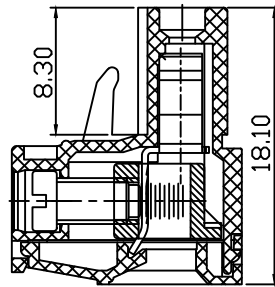
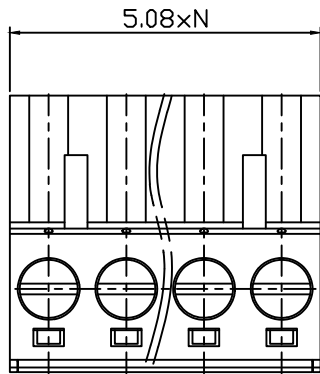

SECTION A-A

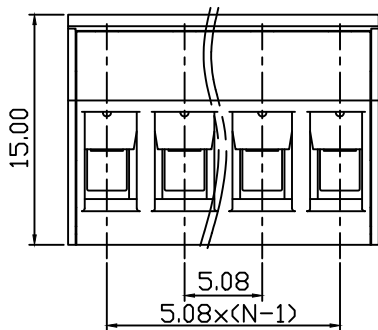

Material
 Housing:PA66,UL94V-0
 Cage:Iron Nickel plated
 Clamp:Phosphor Bronze, Nickel plated
 Screw:M3.0 steel,Zn plated

Electrical
 Rated voltage: 300V
 Rated current:15A
 Contact Resistance: 20 mΩ
 Insulation resistance:500MΩ/DC500V
 Withstand voltage:AC2000V/1min
 Wire Range:28~14AWG/2.5mm²

Mechanical
 Temp.Range:-40℃~+ 105℃
 Strip length:7~8mm
 Torque:5.1kgf-cm(0.5Nm/4.43Lbin)

Order Information

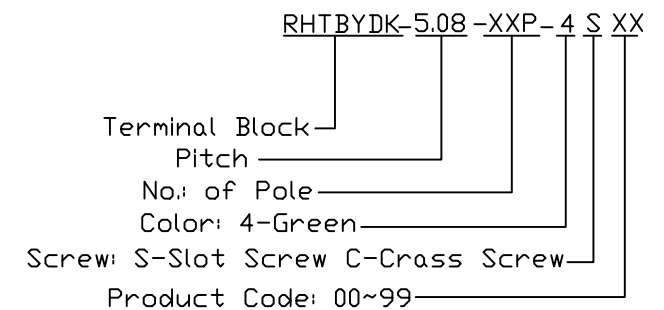

RHTECP NINGBO RHT ELECTRONIC CO.,LTD

UNITS:mm	SHEET SIZE: A4			SCALE:---	DRWN BY PAN
0~3	3~18	18~50	50~120	CHK'D BY FENG	
±0.12	±0.15	±0.3	±0.5	APPR BY ZHAN	

Plug-in TERM BLOCK 5.08MM(Iron)
 THIRD ANGLE PROJECTION
 RHTBYDK-5.08-XXP-4X