

RoHS Compliance

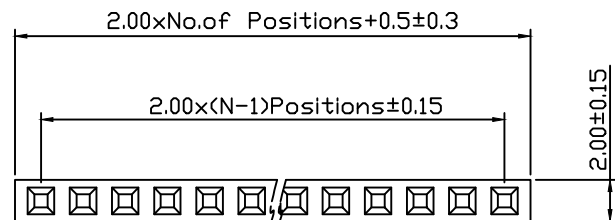

Recommended P.C.B Layout(Top Side)
(PCB BOARD TOLERANCE±0.05)

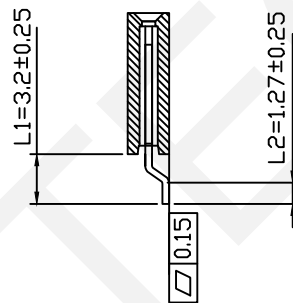
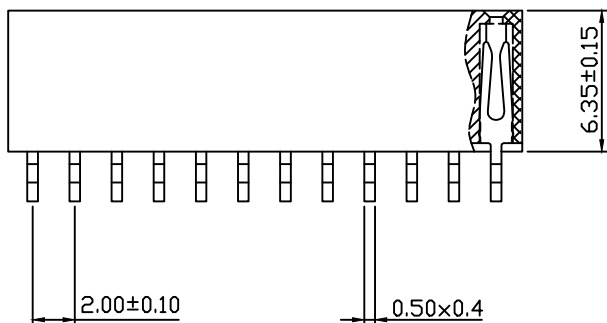
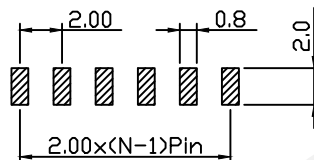

Dimension Antitheses List (mm)			
ITEM	L1	L2	Plastic Height
Standard	3.20	1.27	6.35
Nonstandard	---	---	---

Material:
Standard:PA6T
Contact: Brass
Plating: Au Or Sn Over Ni
Insulator: Polyester, UL94V-0
Electrical Characteristics:
Rated Current: 1.5AMP
Contact Resistance: 20mΩ Max
Withstand Voltage: 500V AC/DC
Insulator Resistance: 1000MΩ Min
Mechanical
Operating Temperature: -40℃~+105℃
Max.Processing Temp: 230℃ For 30-60 Seconds (260℃ For 10 Seconds)

Order Information:
RHTAY08BG-6.35-1-XX-TR-L1xL2-B-R

Pin Header Series
08BG: 2.00mm
Plastics Height: 6.35mm
Per Row: Single Layer
Pin: No. of Pins (1x40)
Type: Horizontal SMT
Size: L1xL2
Material: A=PBT B=PA6T C=LCP
Packing:
A=Tray T=Tube M=Reel+Mylar
P=Tube+Cap R=Reel+Cap

NINGBO RHT ELECTRONIC CO.,LTD

UNITS:mm	SHEET SIZE: A4	SCALE:---	DRWN BY PAN
0~3	3~18	18~50	50~120
±0.12	±0.15	±0.3	±0.5
CHK'D BY FENG		APPR BY ZHAN	

2.0x6.35mm Female Header
Single Layer, Horizontal SMT, 1xN Pin
THIRD ANGLE PROJECTION
 RHTAY08BG-6.35-1-XX-TR-L1xL2-B-R

RoHS Compliance

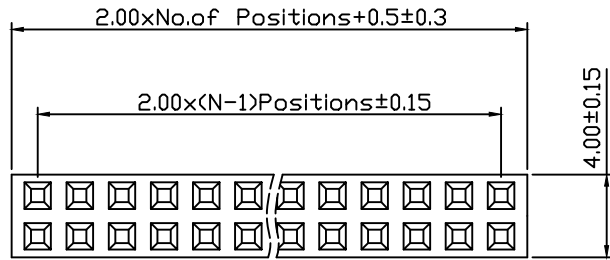

Recommended P.C.B Layout(Top Side)
(PCB BOARD TOLERANCE±0.05)

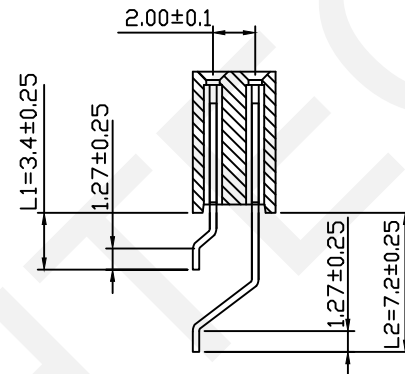
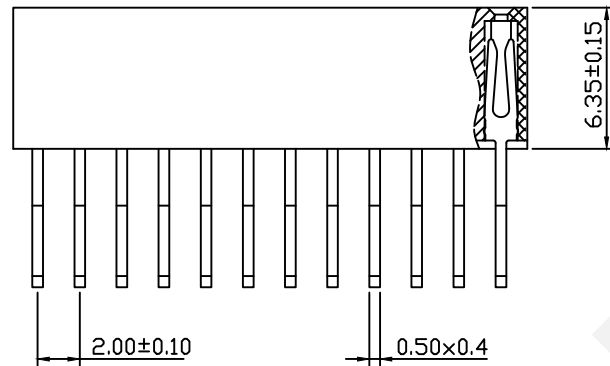
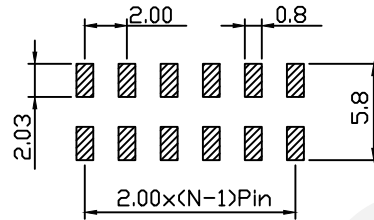

Dimension Antitheses List (mm)			
ITEM	L1	L2	Plastic Height
Standard	3.40	7.20	6.35
Nonstandard	---	---	---

Material:
Standard:PA6T
Contact: Brass
Plating: Au Or Sn Over Ni
Insulator: Polyester, UL94V-0
Electrical Characteristics:
Rated Current: 1.5AMP
Contact Resistance: 20mΩ Max
Withstand Voltage: 500V AC/DC
Insulator Resistance: 1000MΩ Min
Mechanical
Operating Temperature: -40℃~+105℃
Max.Processing Temp: 230℃ For 30-60
Seconds (260℃ For 10 Seconds)

Order Information:

RHTAY08BG-6.35-2-XX-TR-L1xL2-B-R

Pin Header Series
08BG: 2.00mm
Plastics Height: 6.35mm
Per Row: Double Layer
Pin: No. Of Pins (02~80)
Type: Horizontal SMT
Size: L1xL2
Material: A=PBT B=PA6T C=LCP
Packing:
A=Tray T=Tube M=Reel+Mylar
P=Tube+Cap R=Reel+Cap

NINGBO RHT ELECTRONIC CO.,LTD

UNITS:mm	SHEET SIZE: A4	SCALE: ---	DRWN BY PAN
0~3	3~18	18~50	50~120
±0.12	±0.15	±0.3	±0.5

CHK'D BY FENG
APPR BY ZHAN

2.0x6.35mm Female Header
Double Layer, Horizontal SMT, 2xN Pin
THIRD ANGLE PROJECTION
 RHTAY08BG-6.35-2-XX-TR-L1xL2-B-R