

RoHS Compliance

Recommended P.C.B Layout(Top Side)
(PCB BOARD TOLERANCE±0.05)

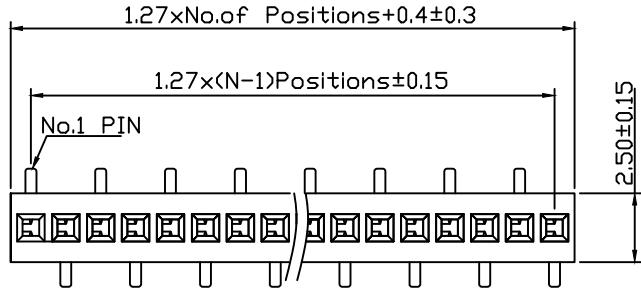

T1 Type

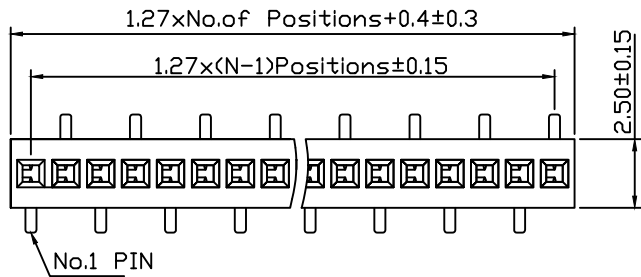
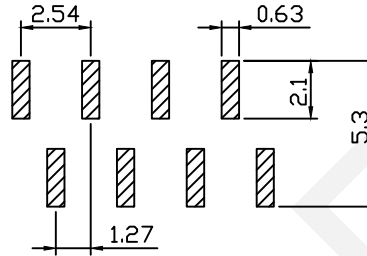

T2 Type

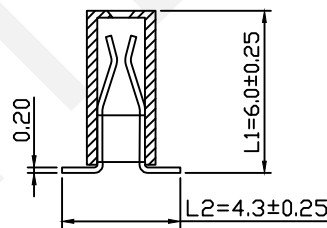
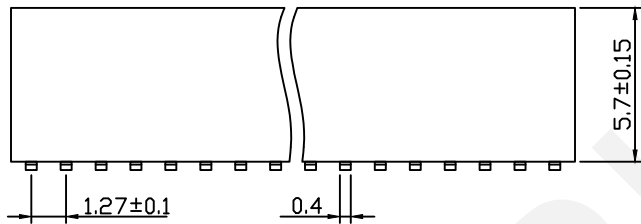
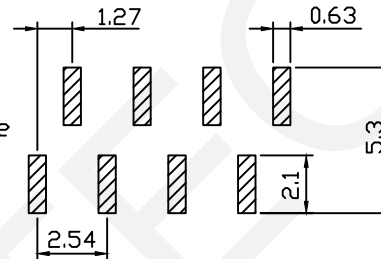

Dimension Antitheses List (mm)			
ITEM	L1	L2	Plastic Height
Standard	6.00	4.30	5.70
Nonstandard	---	---	---

Material:
Standard:PA6T/LCP
Contact: Phosphor Bronze
Plating:Au Or Sn Over Ni
Insulator:Polyester,UL94V-0
Electrical Characteristics:
Rated Current: 1.0AMP
Contact Resistance: 20mΩ Max
Withstand Voltage: 500V AC/DC
Insulator Resistance: 1000MΩ Min
Mechanical
Operating Temperature:-40℃~+105℃
Max.Processing Temp:230℃ For 30-60 Seconds (260℃ For 10 Seconds)

Order Information:
RHTAY08C-5.7-1-XX-T1-L1xL2-N-B-R

Female Header
Series 08C:1.27mm
Plastics Height:5.7mm
Per Row:Single Layer
Pin:No. Of Pins(1x40)
SMT Pins:T1 Type T2 Type
Size:L1xL2
Post:W=With Post N=W/0 Post
Material:B=PA6T C=LCP
Packing:
A=Tray T=Tube M=Reel+Mylar
P=Tube+Cap R=Reel+Cap

NINGBO RHT ELECTRONIC CO.,LTD

UNITS:mm	SHEET SIZE: A4	SCALE:---	DRWN BY PAN
0~3	3~18	18~50	50~120
±0.12	±0.15	±0.3	±0.5
CHK'D BY FENG		APPR BY ZHAN	

1.27mm Female Header
Single Layer, SMT Pin, 1xN Pin
THIRD ANGLE PROJECTION
 RHTAY08C-5.7-1-XX-T1-L1xL2-N-B-R

RoHS Compliance

Recommended P.C.B Layout(Top Side)
(PCB BOARD TOLERANCE±0.05)

Material:
Standard:PA6T/LCP
Contact: Phosphor Bronze
Plating: Au Or Ni
Insulator: Polyester, UL94V-0
Electrical Characteristics:
Rated Current: 1.0AMP
Contact Resistance: 20mΩ Max
Withstand Voltage: 500V AC/DC
Insulator Resistance: 1000MΩ Min
Mechanical
Operating Temperature: -40℃~+105℃
Max.Processing Temp: 230℃ For 30-60
Seconds (260℃ For 10 Seconds)

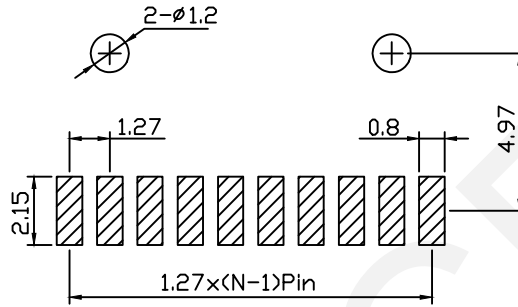
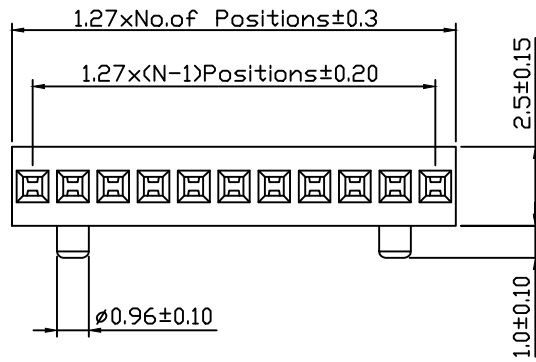

W=With Post N=Without Post

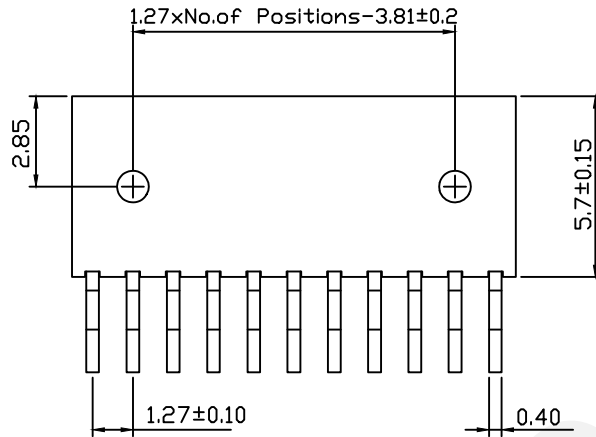
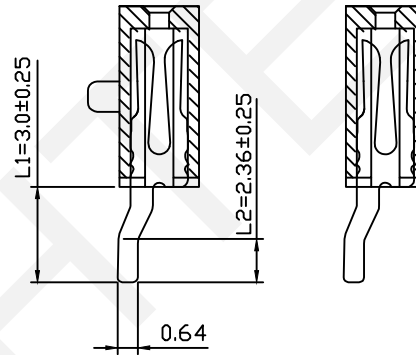

Dimension Antitheses List (mm)			
ITEM	L1	L2	Plastic Height
Standard	3.00	2.36	5.70
Nonstandard	---	---	---

Order Information:
RHTAY08C-5.7-1-XX-RM-L1xL2-N-B-R

Female Header
Series 08C:1.27mm
Plastics Height:5.7mm
Per Row:Single Layer
Pin:No. Of Pins(1x40)
Type: Horizontal SMT
Size:L1xL2
Post:W=With Post
N=Without Post
Material:B=PA6T C=LCP
Packing:
A=Tray T=Tube M=Reel+Mylar
P=Tube+Cap R=Reel+Cap

NINGBO RHT ELECTRONIC CO.,LTD

UNITS:mm	SHEET SIZE: A4	SCALE:---	DRWN BY PAN
0~3	3~18	18~50	50~120
±0.12	±0.15	±0.3	±0.5
CHK'D BY FENG		APPR BY ZHAN	

1.27mm Female Header
Single Layer, Horizontal SMT, 1xN Pin
THIRD ANGLE PROJECTION
 RHTAY08C-5.7-1-XX-RM-L1xL2-N-B-R