

RoHS Compliance

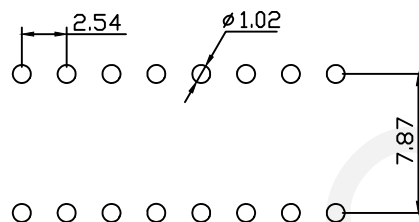

Recommended P.C.B Layout(Top Side)
(PCB BOARD TOLERANCE±0.05)

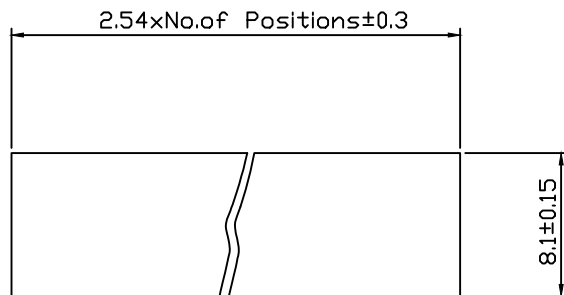
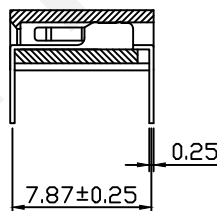
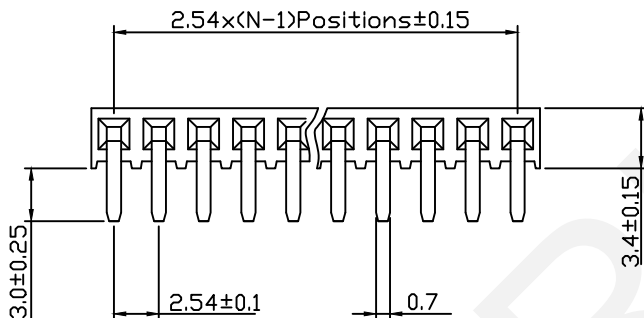

Material:
Standard:PBT/PA6T
Contact: Brass
Plating: Au Or Sn Over Ni
Insulator: Polyester, UL94V-0

Electrical Characteristics:
Rated Current: 3.0AMP
Contact Resistance: 20mΩ Max
Withstand Voltage: 1000V AC/DC
Insulator Resistance: 1000MΩ Min

Mechanical
Operating Temperature: -40℃~+105℃
Max.Processing Temp: 230℃ For 30-60
Seconds (260℃ For 10 Seconds)

Order Information:
RHTAY08A-8.1-1-XX-R-B

Female Header Series
08A: 2.54mm
Plastics Height: 3.4mm
Per Row: Single Layer
Pin: No.of Pins (1x40)
Type: Horizontal DIP
Material: A=PBT B=PA6T C=LCP

RHTECP NINGBO RHT ELECTRONIC CO.,LTD

UNITS:mm	SHEET SIZE: A4	SCALE:---	DRWN BY PAN
0~3	3~18	18~50	50~120
±0.12	±0.15	±0.3	±0.5
			CHK'D BY FENG
			APPR BY ZHAN

2.54x8.1x3.4mm Female Header
Horizontal DIP, 1xN Pin
THIRD ANGLE PROJECTION
 RHTAY08A-8.1-1-XX-R-B

RoHS Compliance

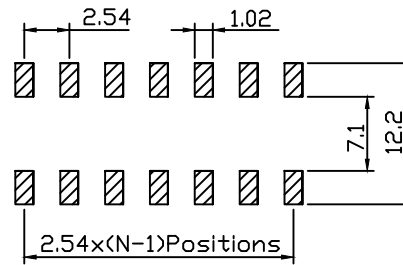
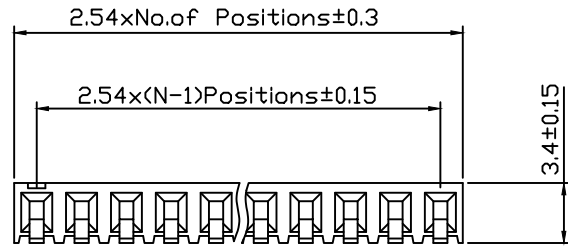

Recommended P.C.B Layout(Top Side)
(PCB BOARD TOLERANCE±0.05)

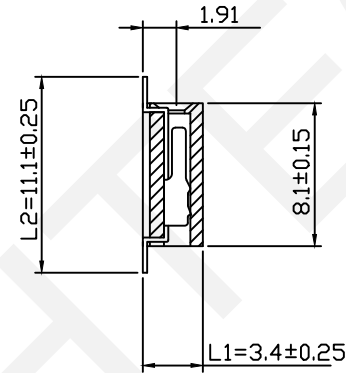
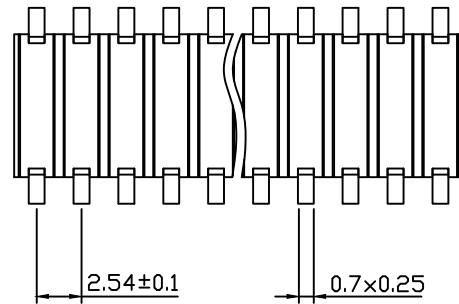

T=Without Post

Dimension Antitheses List (mm)			
ITEM	L1	L2	Plastic Height
Standard	3.40	11.10	3.40
Nonstandard	---	---	---

Material:
Standard: PA6T
Contact: Brass
Plating: Au Or Sn Over Ni
Insulator: Polyester, UL94V-0
Electrical Characteristics:
Rated Current: 3.0AMP
Contact Resistance: 20mΩ Max
Withstand Voltage: 1000V AC/DC
Insulator Resistance: 1000MΩ Min
Mechanical
Operating Temperature: -40℃~+105℃
Max. Processing Temp: 230℃ For 30-60 Seconds (260℃ For 10 Seconds)

Order Information:
RHTAY08A-8.1-1-XX-T-L1xL2-B-R

Female Header Series
08A: 2.54mm
Plastics Height: 3.4mm
Per Row: Single Layer
Pin: No. of Pins (1x40)
SMT Pin: _____
T=Without Post, T3=With Post
Size: L1xL2 _____
Material: A=PBT B=PA6T C=LCP _____
Packing: _____
A=Tray T=Tube M=Reel+Mylar
P=Tube+Cap R=Reel+Cap

NINGBO RHT ELECTRONIC CO.,LTD

UNITS:mm	SHEET SIZE: A4	SCALE:---	DRWN BY PAN
0~3	3~18	18~50	50~120
±0.12	±0.15	±0.3	±0.5

CHK'D BY FENG
APPR BY ZHAN

2.54x8.1x3.4mm Female Header
Horizontal SMT ,1xN Pin
THIRD ANGLE PROJECTION
 RHTAY08A-8.1-1-XX-T-L1xL2-B-R

RoHS Compliance

Material:
 Standard: PBT/PA6T
 Contact: Brass
 Plating: Au or Sn over 50u" Ni
 Insulator: Polyester, UL94V-0

Electrical Characteristics:
 Rated Current: 3.0AMP
 Contact Resistance: 20mΩ Max
 Withstand Voltage: 1000V AC/DC
 Insulator Resistance: 1000MΩ Min

Mechanical
 Operating Temperature: -40°C~+105°C
 Max. Processing Temp: 230°C For 30-60 Seconds (260°C For 10 Seconds)

Order Information:
 RHTAY08A-5.9-2-XX-R-B

Female Header Series
 08A: 2.54mm
 Plastics Height: 5.9mm
 Per Row: Double Layer
 Pin: No. of Pins (02~80)
 Type: Horizontal DIP
 Material: A=PBT B=PA6T C=LCP

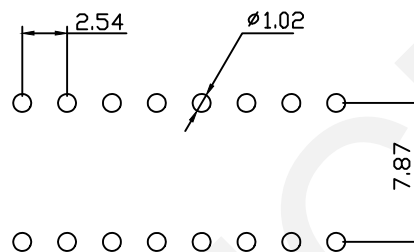
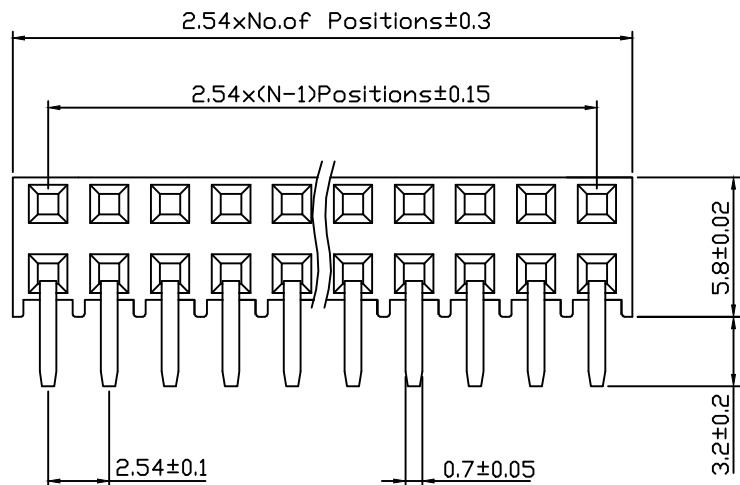

Recommended P.C.B Layout (Top Side)
 (PCB BOARD TOLERANCE ±0.05)

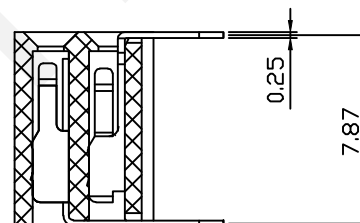
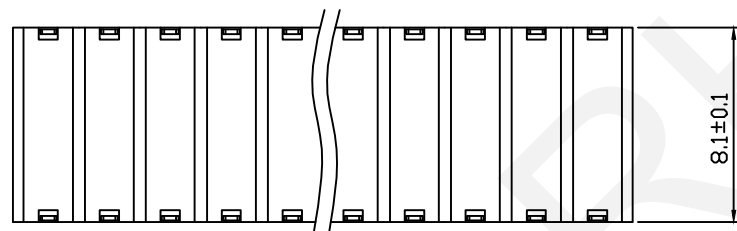

RHTECP NINGBO RHT ELECTRONIC CO.,LTD

UNITS:mm	SHEET SIZE: A4	SCALE:---	DRWN BY PAN
0~3	3~18	18~50	50~120
±0.12	±0.15	±0.3	±0.5
			CHK'D BY FENG
			APPR BY ZHAN

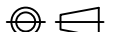
2.54x8.1x5.9mm Female Header
 Horizontal DIP, 2xN Pin
 THIRD ANGLE PROJECTION

 RHTAY08A-5.9-2-XX-S-B

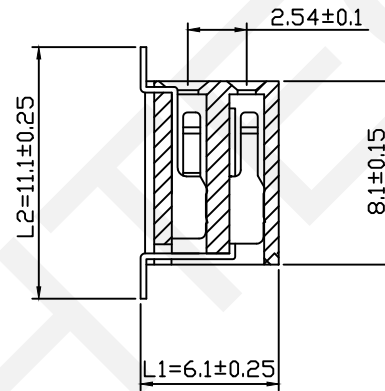
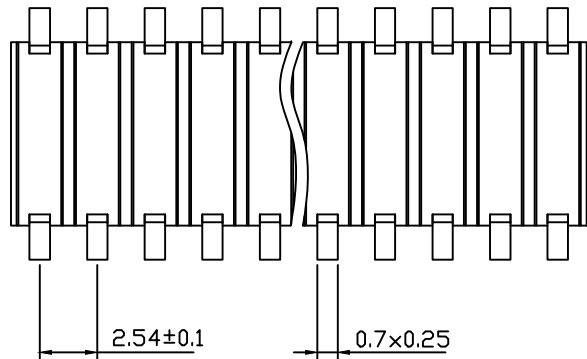
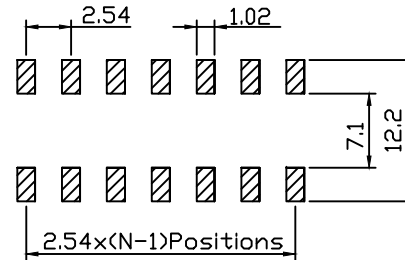
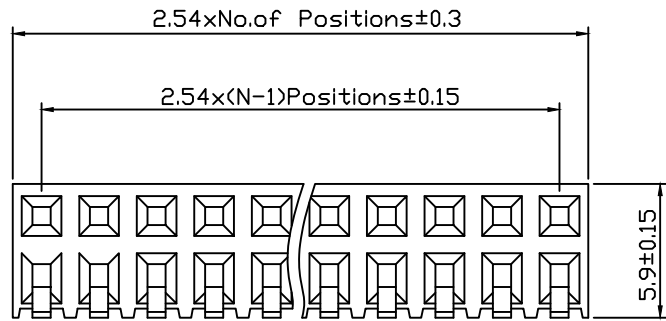
RoHS Compliance



T=Without Post

Dimension Antitheses List (mm)			
ITEM	L1	L2	Plastic Height
Standard	6.10	11.10	5.90
Nonstandard	---	---	---

Material:
 Standard:PA6T
 Contact: Brass
 Plating: Au Or Sn Over 50u" Ni
 Insulator: Polyester, UL94V-0
 Electrical Characteristics:
 Rated Current: 3.0AMP
 Contact Resistance: 20mΩ Max
 Withstand Voltage: 1000V AC/DC
 Insulator Resistance: 1000MΩ Min
 Mechanical
 Operating Temperature: -40℃~+105℃
 Max.Processing Temp: 240℃ For 30-60
 Seconds (260℃ For 10 Seconds)

Order Information:
 RHTAY08A-5.9-2-XX-T-L1xL2-B-R

Female Header Series-
 08A:2.54mm
 Plastics Height:5.9mm
 Per Row:Double Layer
 Pin: No.of Pins (02~80)
 SMT Pin: _____
 T=Without Post.T3=With Post
 Size:L1xL2 _____
 Material:A=PBT B=PA6T C=LCP _____
 Packing: _____
 A=Tray T=Tube M=Reel+Mylar
 P=Tube+Cap R=Reel+Cap

NINGBO RHT ELECTRONIC CO.,LTD

UNITS:mm	SHEET SIZE: A4	SCALE:---	DRWN BY PAN
0~3	3~18	18~50	50~120
±0.12	±0.15	±0.3	±0.5
CHK'D BY FENG		APPR BY ZHAN	

2.54x8.1x5.9mm Female Header
 Horizontal SMT ,2xN Pin
 THIRD ANGLE PROJECTION
 RHTAY08A-5.9-2-XX-T-L1xL2-B-R