

A-A

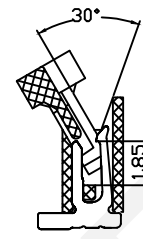

B-B

Material

Housing:LCP UL94V-0

Lock:LCP UL94V-0

Plug Spring:Phosphor Bronze,Gold/Tin

Soldering:Phosphor Bronze,Gold/Tin

Electrical

Voltage Rating: 50 V

Current Rating: 0.5 A

Withstanding Voltage:500V

Insulation Resistance: 800MΩ.Min.

Contact Resistance: 20mΩ.Max.

Mechanical

Temp.Range:-25℃~+85℃

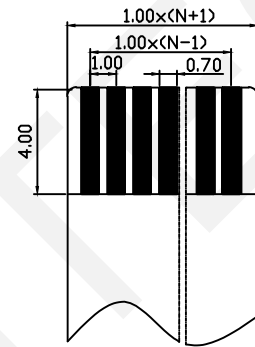
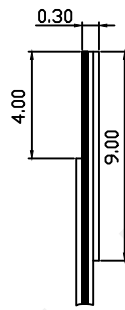
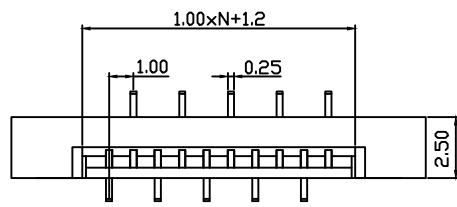

Proper Cable

Order Information

RHTAY240D-5.5-XX-T-P-R

Series No.]

No.0f Pins(04~30 Pins)

Vertical SMT Pin

Positive Needle

Packing:T-Tube R-Reel

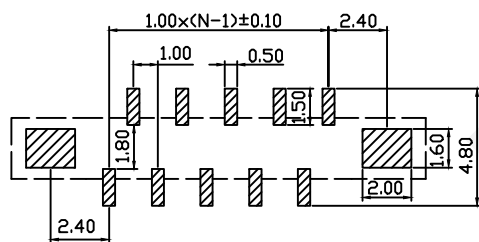

PCB Layout



NINGBO RHT ELECTRONIC CO.,LTD

UNITS:mm

SHEET SIZE: A4

SCALE:---

DRWN BY PAN

CONN FFC 1.00mm,Positive Needle,SMD, Vertical,With ZIF

0~3

3~18

18~50

50~120

CHK'D BY FENG

THIRD ANGLE PROJECTION

RHTAY240D-5.5-XX-T-P-R

±0.12

±0.15

±0.3

±0.5

APPR BY ZHAN

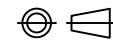

1

2

3

4

5

6

7

8

9

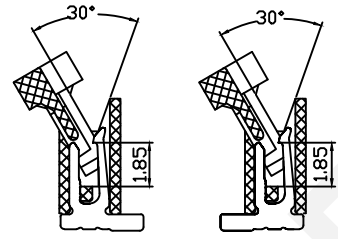
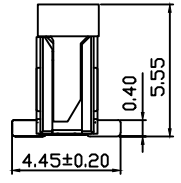
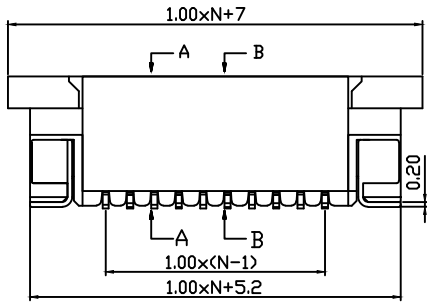

Material  
 Housing:LCP UL94V-0  
 Lock:LCP UL94V-0  
 Plug spring:Phosphor Bronze,Gold/Tin  
 Soldering:Phosphor Bronze,Gold/Tin

Electrical  
 Voltage Rating: 50 V  
 Current Rating: 0.5 A  
 Withstanding Voltage:500V  
 Insulation Resistance: 800MΩ,Min.  
 Contact Resistance: 20mΩ,Max.

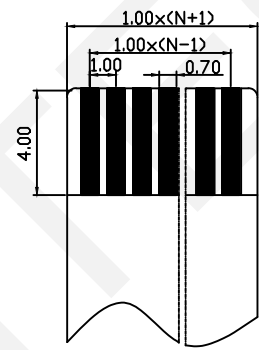
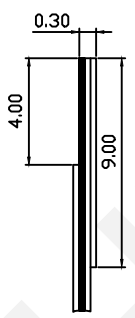
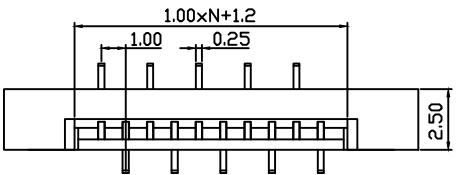

Mechanical  
 Temp.Range:-25℃~+85℃

Order Information

RHTAY240D-5.5-XX-T-A-R

Series No. ]  
 No. of Pins(04~30 Pins)  
 Vertical SMT Pin  
 Anti-Needle  
 Packing:T-Tube R-Reel

Proper Cable

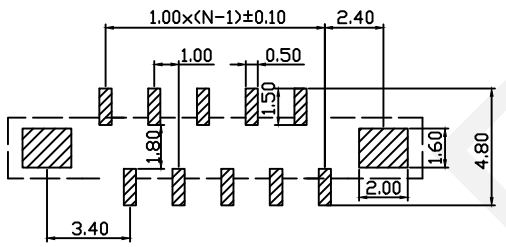

PCB Layout



NINGBO RHT ELECTRONIC CO.,LTD

UNITS:mm	SHEET SIZE: A4		SCALE:---		DRWN BY PAN
0~3	3~18	18~50	50~120	CHK'D BY FENG	
±0.12	±0.15	±0.3	±0.5	APPR BY ZHAN	

CONN FFC 1.00mm,Anti-Needle, SMD,Vertical,With ZIF	
THIRD ANGLE PROJECTION 	RHTAY240D-5.5-XX-T-A-R