

RoHS Compliance

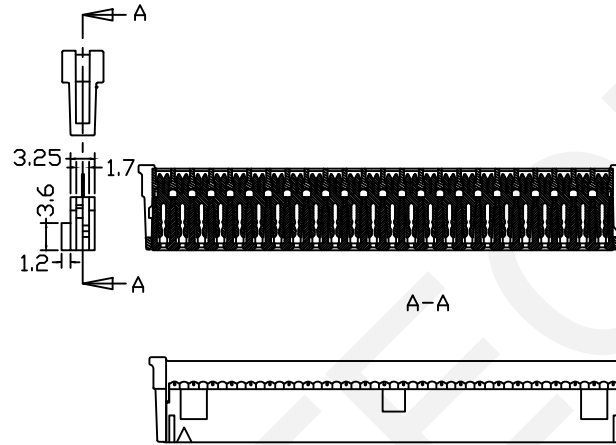
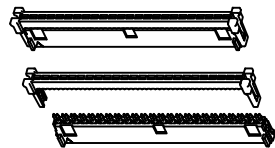
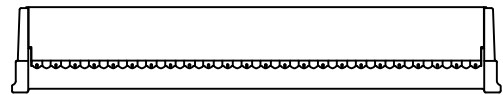
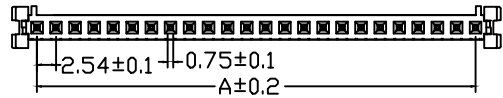
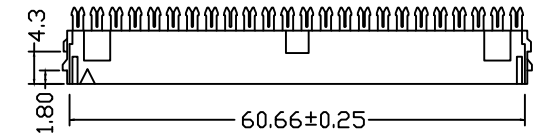
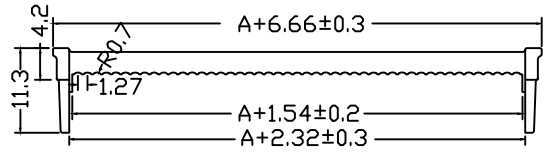

PART NO	Dim.A
8	17.78
10	22.86
14	33.02
16	38.10
24	58.42

MATERIAL&FINISH

Insulator:PBT Glass Fiber(UL94V-0)

Contact:Phosphorus Bronze

Contact:Gold-Plated Over Nickel

Contact Material:Phosphorus Bronze T=0.30

SPECIFICATIONS

Current Rating:1A

Voltage Rating:250V

Contact Resistance:20mΩMin

Insulator Resistance:1000mΩ

Operating Temperature: -45℃~+105℃

Order Information:

RHTAY04P-XX-B

I.D.C SOCKET 2.54mm Series

Number of Contacts: XX=08-24Pin

Insulator Color: B = Black

 NINGBO RHT ELECTRONIC CO.,LTD

UNITS:mm	SHEET SIZE: A4	SCALE:---	DRWN BY PAN
0~3	3~18	18~50	50~120
±0.12	±0.15	±0.3	±0.5
CHK'D BY FENG		APPR BY ZHAN	

2.54mm Pitch IDC Socket Connector

THIRD ANGLE PROJECTION

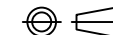

RHTAY04P-XX-B