

RoHS Compliant

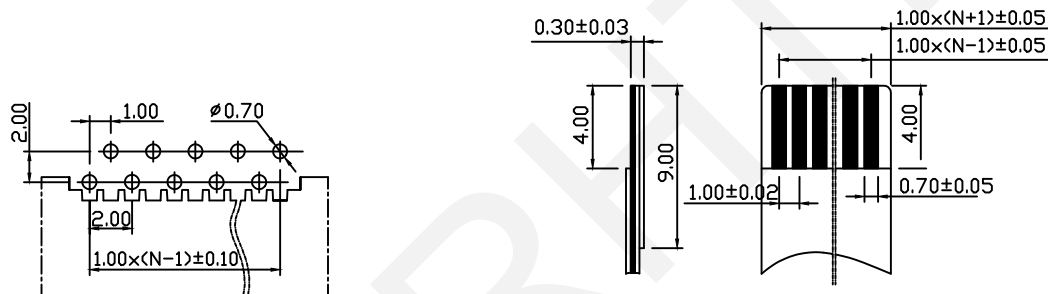
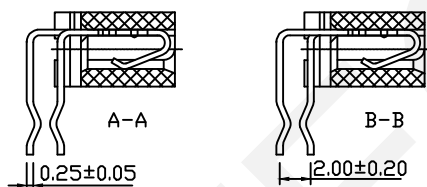
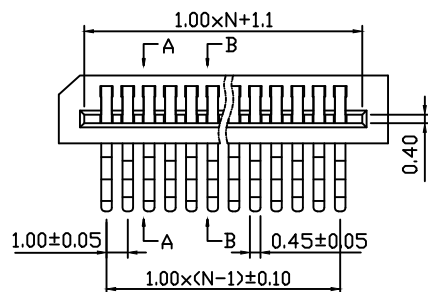
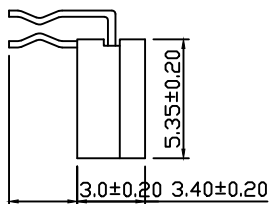
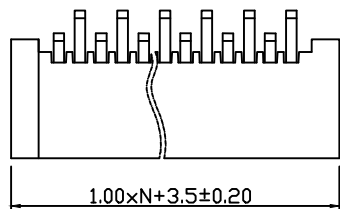

PCB Layout

Proper Cable

Material  
Housing:LCP UL94V-0  
Contact:Phosphor Bronze,Tin/Plated

Electrical  
Voltage Rating: 50V  
Current Rating: 0.5A  
Withstand Voltage:500V  
Insulation Resistance:500MΩ.Min.  
Contact Resistance:30mΩ.Max.

Mechanical  
Temp Range:-25℃~+85℃

Order Information

RHTAY40-XX-R-P-T

Series No. \_\_\_\_\_  
No. of Pins \_\_\_\_\_  
(04~30 Pins)  
R-Right Angle Pin \_\_\_\_\_  
P-Positive Needle \_\_\_\_\_  
Packing: T-Tube \_\_\_\_\_

**RHTECP** NINGBO RHT ELECTRONIC CO.,LTD

UNITS:mm	SHEET SIZE: A4			SCALE:---	DRWN BY PAN
0~3	3~18	18~50	50~120	CHK'D BY FENG	
±0.12	±0.15	±0.3	±0.5	APPR BY ZHAN	

CONN FFC 1.00mm,P-Positive Needle ,THR,90°

THIRD ANGLE PROJECTION

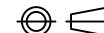

RHTAY40-XX-R-P-T

1  
RoHS Compliant

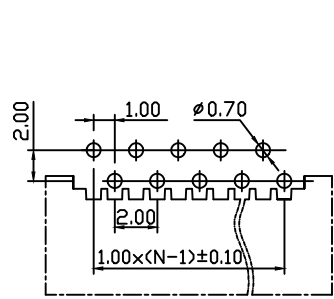
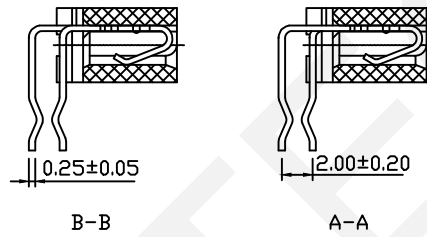
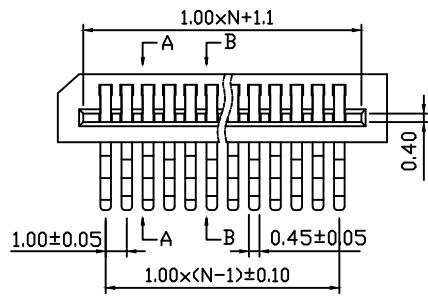
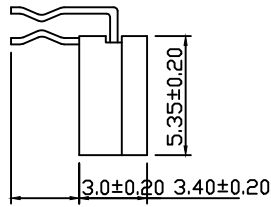
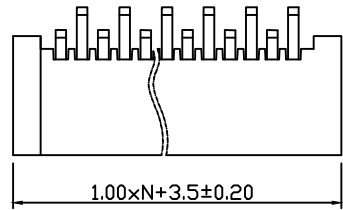

PCB Layout

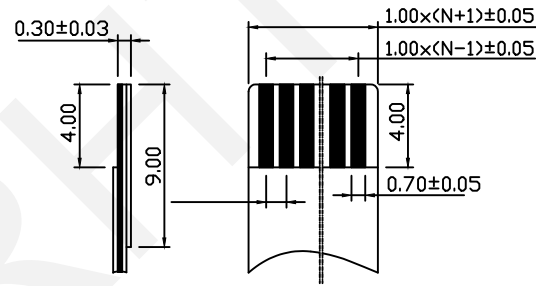

Proper Cable

Material

Housing:LCP UL94V-0

Contact:Phosphor Bronze,Tin/Plated

Electrical

Voltage Rating: 50V

Current Rating: 0.5A

Withstand Voltage:500V

Insulation Resistance:500MΩ.Min.

Contact Resistance:30mΩ.Max.

Mechanical

Temp Range:-25℃~+85℃

Order Information

RHTAY40-XX-R-A-T

Series No. \_\_\_\_\_

No.of Pins \_\_\_\_\_

(04~30 Pins)

R-Right Angle Pin \_\_\_\_\_

A-Anti-Needle \_\_\_\_\_

Packing: T-Tube \_\_\_\_\_

**RHTECP** NINGBO RHT ELECTRONIC CO.,LTD

UNITS:mm	SHEET SIZE: A4			SCALE:---	DRWN BY PAN
0~3	3~18	18~50	50~120	CHK'D BY FENG	
±0.12	±0.15	±0.3	±0.5	APPR BY ZHAN	

CONN FFC 1.00mm,Anti-Needle,THR,90°

THIRD ANGLE PROJECTION

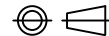

RHTAY40-XX-R-A-T

RoHS Compliant

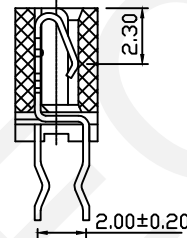
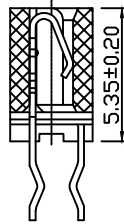
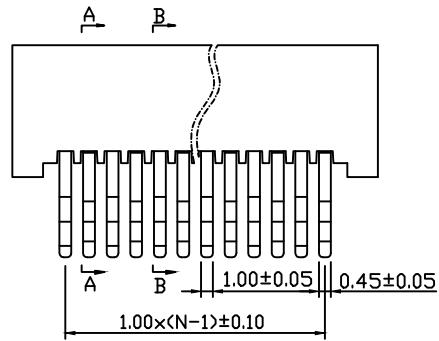
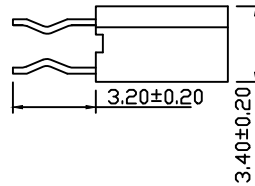
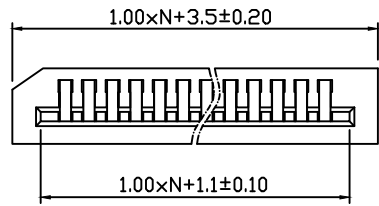

A-A

B-B

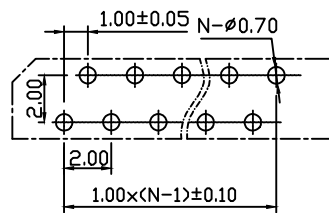

PCB Layout

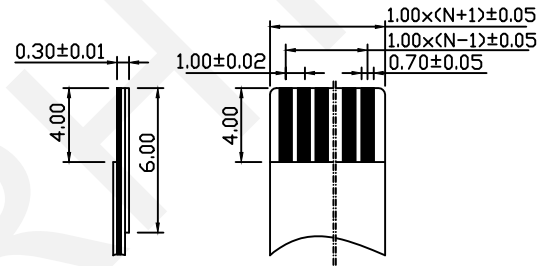

Proper Cable

Material  
Housing:LCP UL94V-0  
Contact:Phosphor Bronze,Tin/Plated

Electrical  
Voltage Rating: 50V  
Current Rating: 0.5A  
Withstand Voltage:500V  
Insulation Resistance:500MΩ.Min.  
Contact Resistance:30mΩ.Max.

Mechanical  
Temp Range:-25℃~+85℃

Order Information

RHTAY40-XX-S-P-T

Series No. \_\_\_\_\_

No.of Pins \_\_\_\_\_

(04~30 Pins)

S-Straight Pin \_\_\_\_\_

P-Positive Needle \_\_\_\_\_

Packing: T-Tube \_\_\_\_\_

**RHTECP** NINGBO RHT ELECTRONIC CO.,LTD

UNITS:mm	SHEET SIZE: A4			SCALE:---
0~3	3~18	18~50	50~120	
±0.12	±0.15	±0.3	±0.5	

DRWN BY PAN  
CHK'D BY FENG  
APPR BY ZHAN

CONN FFC 1.00mm,P-Positive Needle ,THR,180°

THIRD ANGLE PROJECTION

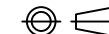

RHTAY40-XX-S-P-T

1  
RoHS Compliant

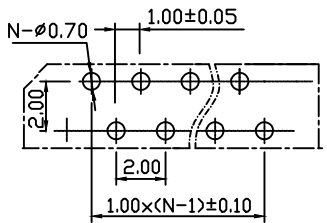
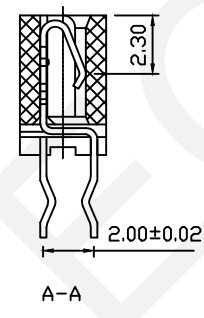
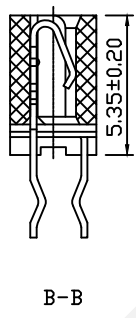
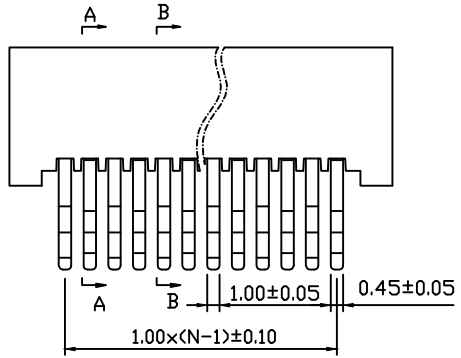
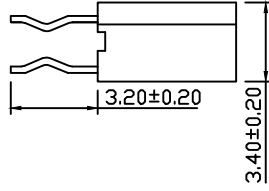
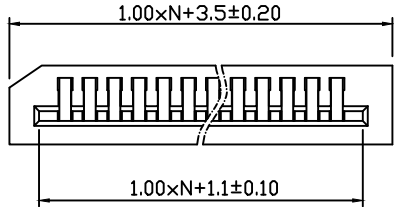

PCB Layout

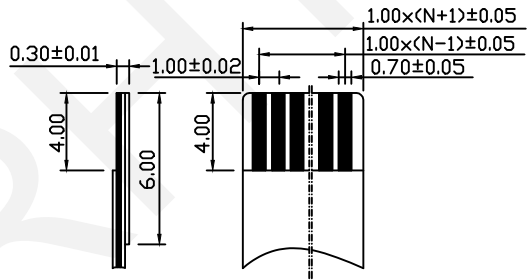

Proper Cable

Material  
Housing: LCP UL94V-0  
Contact: Phosphor Bronze, Tin/Plated

Electrical  
Voltage Rating: 50V  
Current Rating: 0.5A  
Withstand Voltage: 500V  
Insulation Resistance: 500MΩ.Min.  
Contact Resistance: 30mΩ.Max.

Mechanical  
Temp Range: -25°C~+85°C

Order Information  
RHTAY40-XX-S-A-T

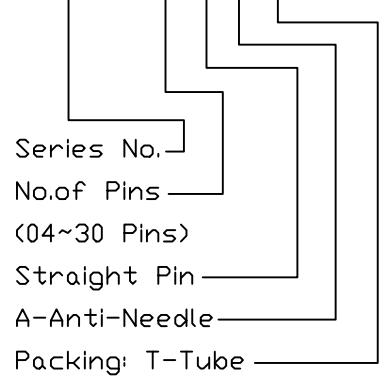

1  
RHTECP® NINGBO RHT ELECTRONIC CO.,LTD

UNITS:mm	SHEET SIZE: A4			SCALE:---	DRWN BY PAN
0~3	3~18	18~50	50~120	CHK'D BY FENG	
±0.12	±0.15	±0.3	±0.5	APPR BY ZHAN	

CONN FFC 1.00mm, Anti-Needle, THR, 180°  
THIRD ANGLE PROJECTION  
RHTAY40-XX-S-A-T

RoHS Compliant

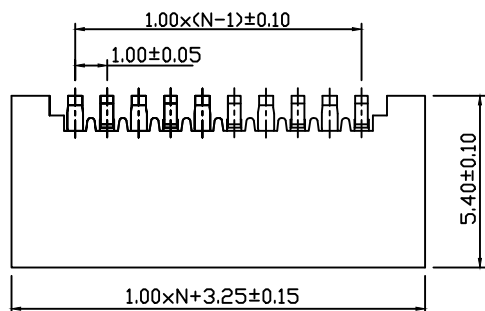
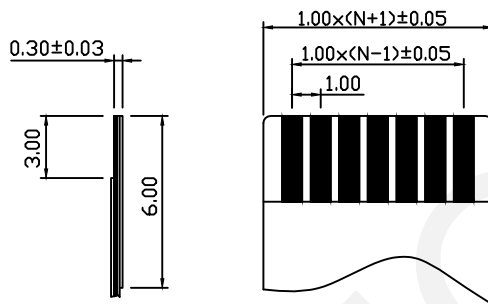
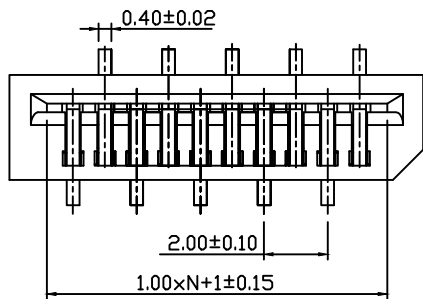

Accommodated FFC

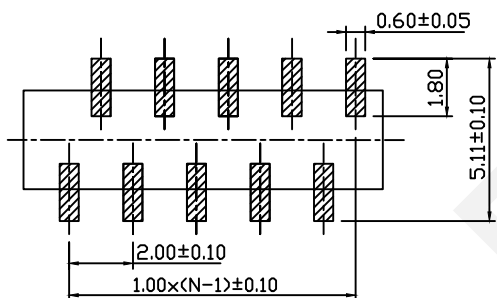

PCB LAYOUT  
Positive Needle

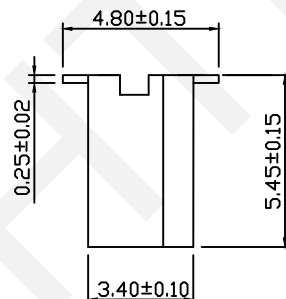

Material  
Housing:LCP UL94V-0  
Contact:Phosphor Bronze,Tin/Plated

Electrical  
Voltage Rating: 50V  
Current Rating: 0.5A  
Withstand Voltage:500V  
Insulation Resistance:500MΩ,Min.  
Contact Resistance:30mΩ,Max.

Mechanical  
Temp Range:-25℃~+85℃

Order Information  
RHTAY40-XX-T-P-R

Series No. \_\_\_\_\_  
No.of Pins \_\_\_\_\_  
(04~30 Pins)  
T-SMT Pin,Vertical  
P-Positive Needle  
Packing: T-Tube R-Reel

NINGBO RHT ELECTRONIC CO.,LTD

UNITS:mm	SHEET SIZE: A4			SCALE:---	DRWN BY PAN
0~3	3~18	18~50	50~120	CHK'D BY FENG	
±0.12	±0.15	±0.3	±0.5	APPR BY ZHAN	

CONN FFC 1.00mm,SMD Vertical,Positive Needle

THIRD ANGLE PROJECTION

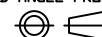

RHTAY40-XX-T-P-R

RoHS Compliant

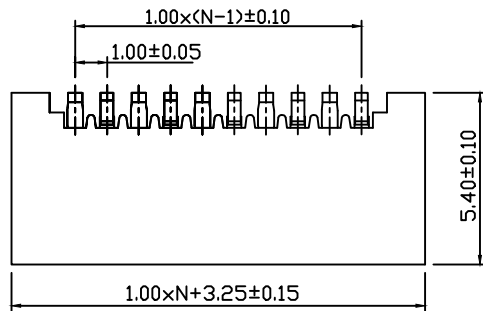
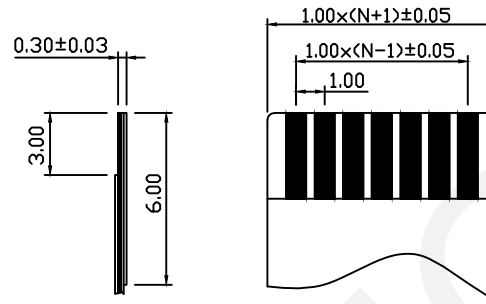
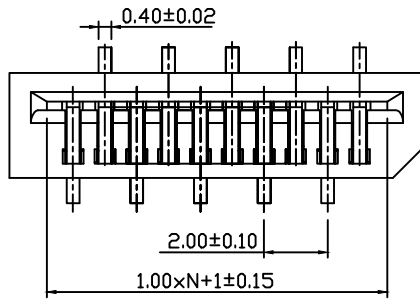

Accommodated FFC

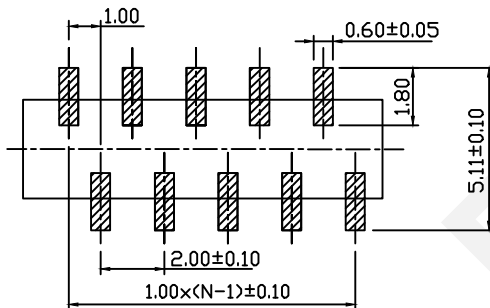

PCB LAYOUT  
Positive Needle

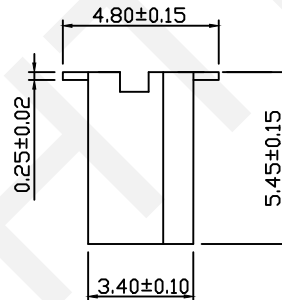

Material  
Housing:LCP UL94V-0  
Contact:Phosphor Bronze,Tin/Plated

Electrical  
Voltage Rating: 50V  
Current Rating: 0.5A  
Withstand Voltage:500V  
Insulation Resistance:500MΩ.Min.  
Contact Resistance:30mΩ.Max.

Mechanical  
Temp Range:-25℃~+85℃

Order Information  
RHTAY40-XX-T-A-R

Series No. \_\_\_\_\_  
No.of Pins \_\_\_\_\_  
(04~30 Pins)  
T-SMT Pin,Vertical  
A-Anti-Needle \_\_\_\_\_  
Packing: T-Tube R-Reel \_\_\_\_\_

NINGBO RHT ELECTRONIC CO.,LTD

UNITS:mm	SHEET SIZE: A4			SCALE:---	DRWN BY PAN
0~3	3~18	18~50	50~120	CHK'D BY FENG	
±0.12	±0.15	±0.3	±0.5	APPR BY ZHAN	

CONN FFC 1.00mm,SMD Vertical,Anti-Needle

THIRD ANGLE PROJECTION

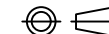

RHTAY40-XX-T-A-R