

RoHS Compliance

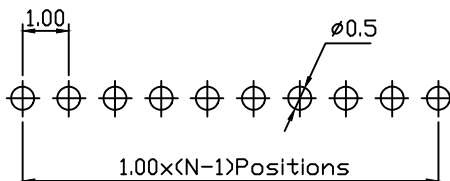

Recommended P.C.B Hole Layout

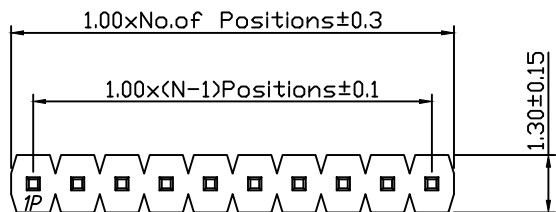
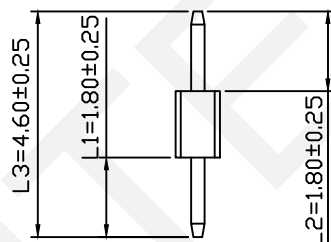
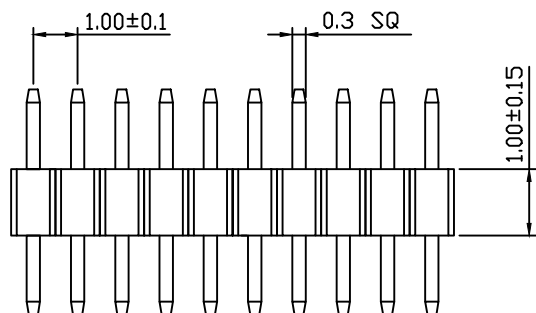

Dimension Antitheses List (mm)				
ITEM	L1	L2	L3	Plastic Height
Standard	1.80	1.80	4.60	1.00
Nonstandard	---	---	---	---

Material:
 Standard: PA6T
 Contact: Brass
 Insulator: Polyester,UL94V-0
 Electrical Characteristics:
 Rated Current: 0.75AMP
 Contact Resistance: 30mΩ Max
 Withstand Voltage: 500V AC/DC
 Insulator Resistance: 1000MΩ Min
 Mechanical
 Operating Temperature: -40°C~+105°C
 Max.Processing Temp:230°C For30-60 Seconds(260°C For10 Seconds)

Order Information:
 RHTAY07G-1.00-1-XX-S-L1xL2xL3-G0

Pin Header Series
 07G:1.00mm
 Plastics Height: 1.00,1.50mm
 Per Row:Single Layer
 Pin: No. Of Pins (1x50)
 Type: Straight Pin.
 Size:L1xL2xL3
 Plating:
 G0=Gold Flash G1=1u" Gold
 G10=10u" Gold G15=15u" Gold
 G30=30u" Gold

RHTECP NINGBO RHT ELECTRONIC CO.,LTD

UNITS:mm SHEET SIZE: A4 SCALE:---
 0~3 3~18 18~50 50~120
 ±0.12 ±0.15 ±0.3 ±0.5

DRWN BY PAN
 CHK'D BY FENG
 APPR BY ZHAN

1.00mm Pin Header
 Single Layer, Straight Pin, 1xN Pin
 THIRD ANGLE PROJECTION
 RHTAY07G-1.00-1-XX-S-L1xL2xL3-G0

RoHS Compliance

Material:
 Standard: PA6T
 Contact: Brass
 Insulator: Polyester,UL94V-0
 Electrical Characteristics:
 Rated Current: 0.75AMP
 Contact Resistance: 20mΩ Max
 Withstand Voltage: 500V AC/DC
 Insulator Resistance: 1000MΩ Min
 Mechanical
 Operating Temperature: -40°C~+105°C
 Max.Processing Temp:230°C For30-60
 Seconds(260°C For10 Seconds)

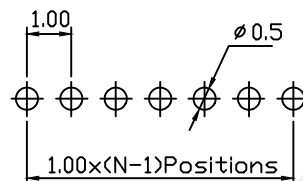
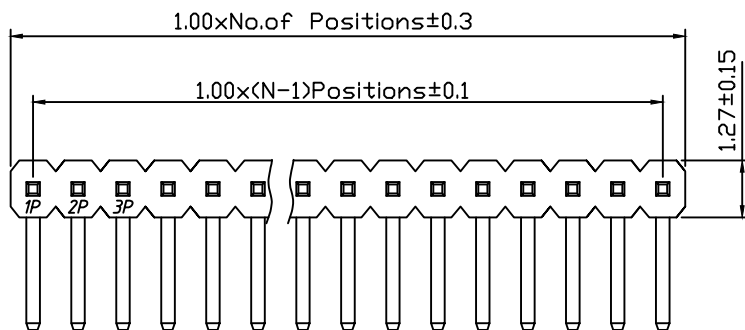

Recommended P.C.B Hole Layout

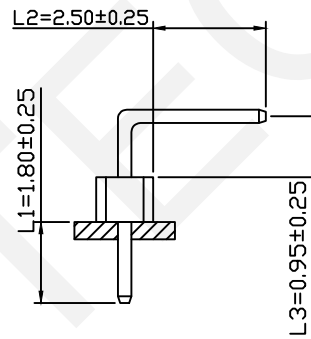
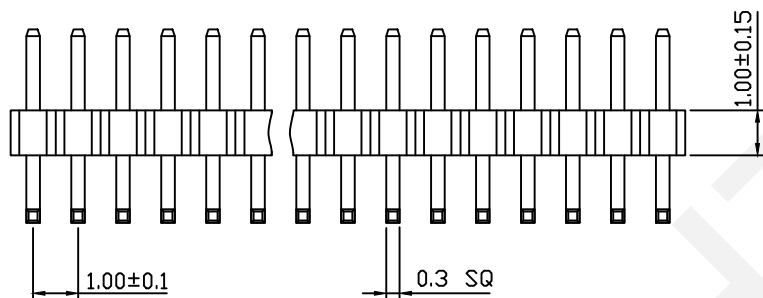

R1 Type

Order Information:
 RHTAY07G-1.00-1-XX-R1-L1xL2xL3-G0

Pin Header Series
 07G:1.00mm
 Plastics Height: 1.00,1.50mm
 Per Row:Single Layer
 Pin: No. Of Pins (1x50)
 Type:Right Angle Pin
 Size:L1xL2xL3
 Plating:
 G0=Gold Flash G1=1u" Gold
 G10=10u" Gold G15=15u" Gold
 G30=30u" Gold

Dimension Antitheses List (mm)

ITEM	L1	L2	L3	Plastic Height
Standard	1.80	2.50	0.95	1.00
Nonstandard	---	---	---	---

UNITS:mm	SHEET SIZE: A4	SCALE:---	DRWN BY PAN
0~3	3~18	18~50	50~120
±0.12	±0.15	±0.3	±0.5
CHK'D BY FENG		APPR BY ZHAN	

1.00mm Pin Header Single Layer,Right Angle Pin, 1xN Pin	
THIRD ANGLE PROJECTION 	RHTAY07G-1.00-1-XX-R1-L1xL2xL3-G0



NINGBO RHT ELECTRONIC CO.,LTD

RHTAY07G-1.00-1-XX-R1-L1xL2xL3-G0

RoHS Compliance

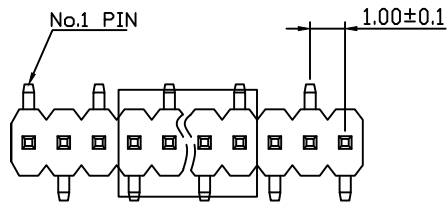

Recommended P.C.B Layout

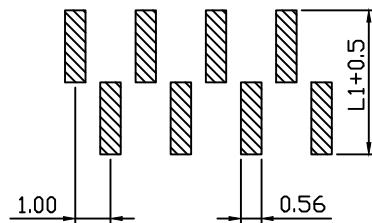

T1 Type

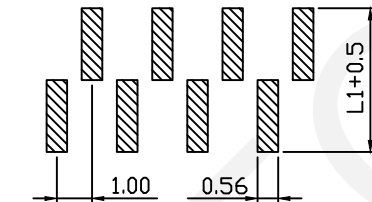
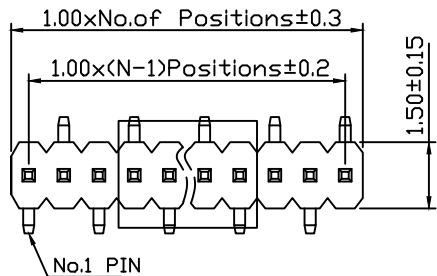

T2 Type

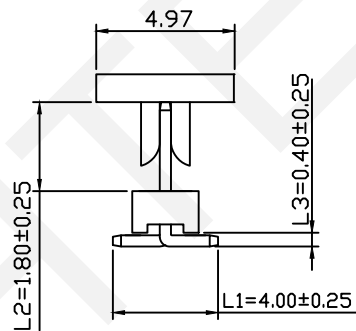
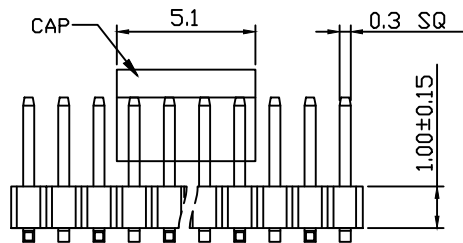

Dimension Antitheses List (mm)				
ITEM	L1	L2	L3	Plastic Height
Standard	4.00	1.80	0.40	1.00
Nonstandard	---	---	---	---

Material:
 Standard: PA6T
 Contact: Brass
 Insulator: Polyester,UL94V-0
 Electrical Characteristics:
 Rated Current: 0.75AMP
 Contact Resistance: 30mΩ Max
 Withstand Voltage: 500V AC/DC
 Insulator Resistance: 1000MΩ Min
 Mechanical
 Operating Temperature: -40°C~+105°C
 Max.Processing Temp:230°C For30-60 Seconds(260°C For10 Seconds)

Order Information:
 RHTAY07G-1.00-1-XX-T1-L1xL2xL3-G0

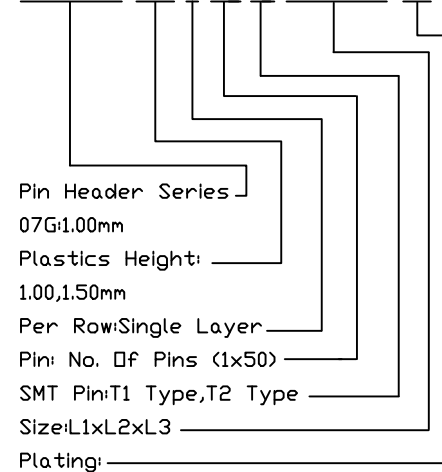

G0=Gold Flash G1=1u" Gold
 G10=10u" Gold G15=15u"
 Gold G30=30u" Gold

RHTECP NINGBO RHT ELECTRONIC CO.,LTD

UNITS:mm SHEET SIZE: A4 SCALE:--- DRWN BY PAN
 0~3 3~18 18~50 50~120 CHK'D BY FENG
 ±0.12 ±0.15 ±0.3 ±0.5 APPR BY ZHAN

1.00mm Pin Header Single Layer,SMT,1xN Pin
 THIRD ANGLE PROJECTION
 RHTAY07G-1.00-1-XX-T1-L1xL2xL3-G0

RoHS Compliance

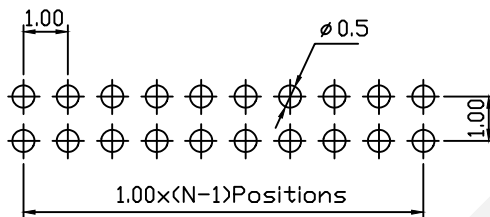
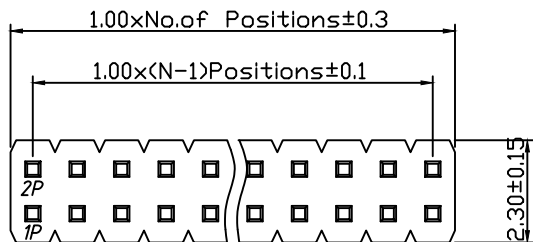

Recommended P.C.B Hole Layout

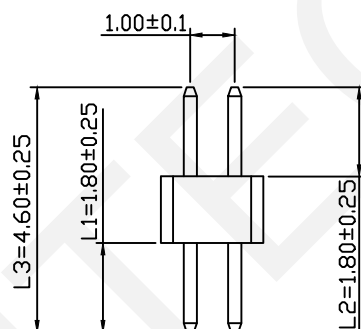
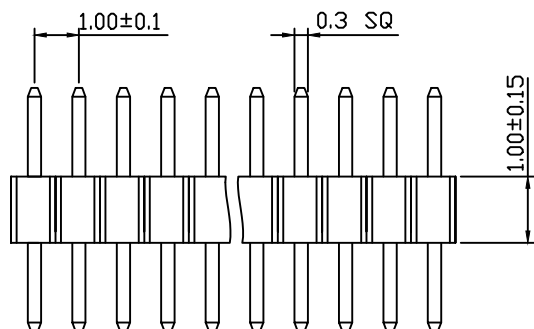

Dimension Antitheses List (mm)				
ITEM	L1	L2	L3	Plastic Height
Standard	1.80	1.80	4.60	1.00
Nonstandard	---	---	---	---

Material:
 Standard: PA6T
 Contact: Brass
 Insulator: Polyester,UL94V-0
 Electrical Characteristics:
 Rated Current: 0.75AMP
 Contact Resistance: 30mΩ Max
 Withstand Voltage: 500V AC/DC
 Insulator Resistance: 1000MΩ Min
 Mechanical
 Operating Temperature: -40°C~+105°C
 Max.Processing Temp:230°C For30-60 Seconds(260°C For10 Seconds)

Order Information:
 RHTAY07G-1.00-2-XX-S-L1xL2xL3-G0

Pin Header Series
 07G:1.00mm
 Plastics Height: 1.00,1.50mm
 Per Row:Double Layer
 Pin: No. Of Pins (2~100)
 Type: Straight Pin.
 Size:L1xL2xL3
 Plating:
 G0=Gold Flash G1=1u" Gold
 G10=10u" Gold G15=15u" Gold
 G30=30u" Gold

RHTECP NINGBO RHT ELECTRONIC CO.,LTD

UNITS:mm	SHEET SIZE: A4	SCALE:---	DRWN BY PAN
0~3	3~18	18~50	50~120
±0.12	±0.15	±0.3	±0.5
CHK'D BY FENG		APPR BY ZHAN	

1.00mm Pin Header
 Double Layer, Straight Pin, 2xN Pin
 THIRD ANGLE PROJECTION
 RHTAY07G-1.00-2-XX-S-L1xL2xL3-G0

RoHS Compliance

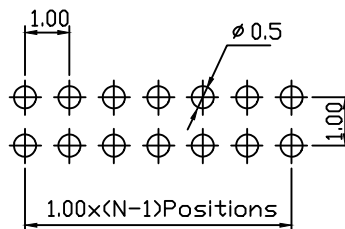
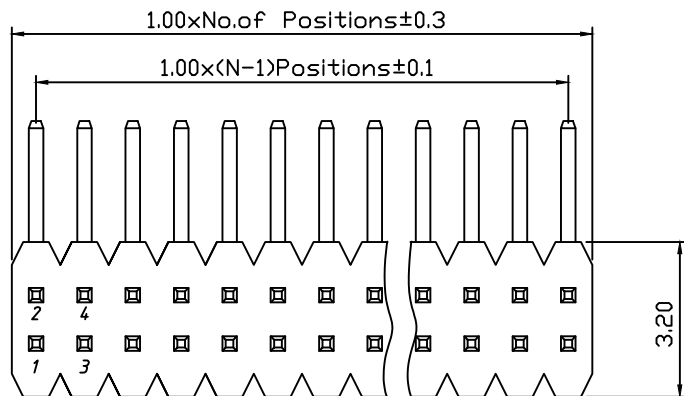

Recommended P.C.B Hole Layout

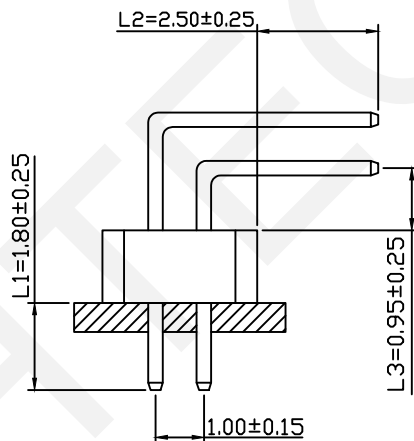
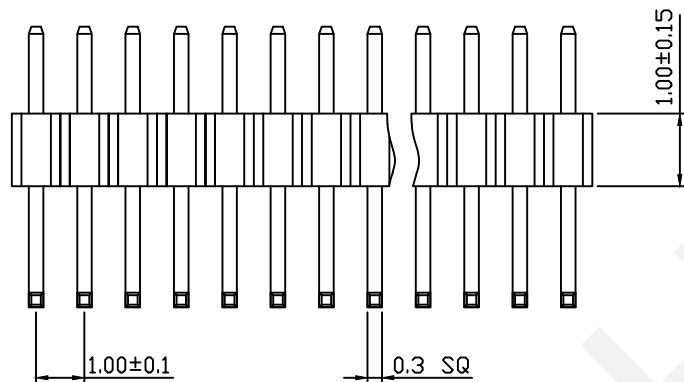

R2 Type

Dimension Antitheses List (mm)				
ITEM	L1	L2	L3	Plastic Height
Standard	1.80	2.50	0.95	1.00
Nonstandard	---	---	---	---

Material:
 Standard: PA6T
 Contact: Brass
 Insulator: Polyester,UL94V-0
 Electrical Characteristics:
 Rated Current: 0.75AMP
 Contact Resistance: 20mΩ Max
 Withstand Voltage: 500V AC/DC
 Insulator Resistance: 1000MΩ Min
 Mechanical
 Operating Temperature: -40°C~+105°C
 Max.Processing Temp:230°C For30-60 Seconds(260°C For10 Seconds)

Order Information:
RHTAY07G-1.00-2-XX-R2-L1xL2xL3-G0

Pin Header Series
 07G:1.00mm
 Plastics Height: 1.00,1.50mm
 Per Row:Double Layer
 Pin: No. Of Pins (2~100)
 Type:Right Angle Pin
 Size:L1xL2xL3
 Plating:
 G0=Gold Flash G1=1u" Gold
 G10=10u" Gold G15=15u" Gold
 G30=30u" Gold

NINGBO RHT ELECTRONIC CO.,LTD

UNITS:mm SHEET SIZE: A4 SCALE:--- DRWN BY PAN
 0~3 3~18 18~50 50~120 CHK'D BY FENG
 ±0.12 ±0.15 ±0.3 ±0.5 APPR BY ZHAN

1.00mm Pin Header
 Double Layer,Right Angle Pin, 2xN Pin
 THIRD ANGLE PROJECTION
 RHTAY07G-1.00-2-XX-R2-L1xL2xL3-G0

RoHS Compliance

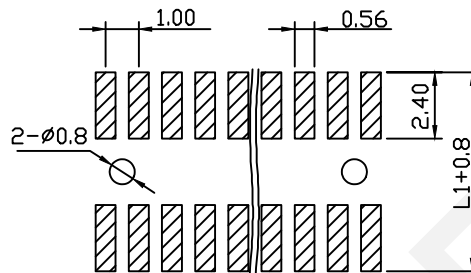
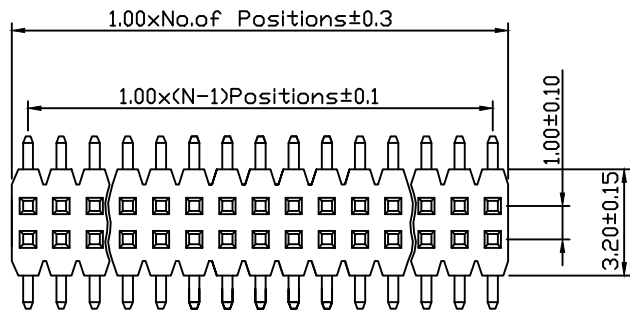

Recommended P.C.B Hole Layout

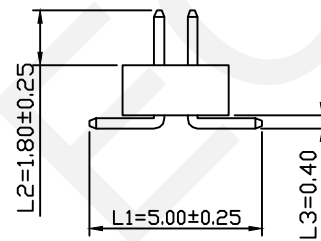
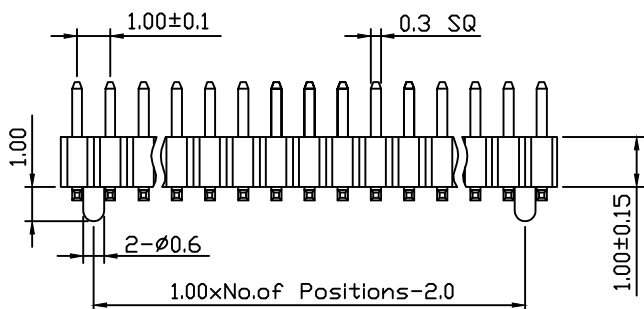

T=W/D Post

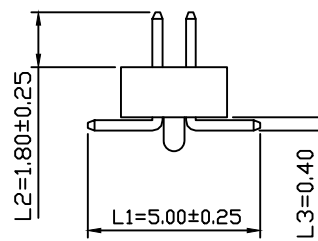

T3=With Post

Dimension Antitheses List (mm)				
ITEM	L1	L2	L3	Plastic Height
Standard	5.00	1.80	0.40	1.00
Nonstandard	---	---	---	---

Material:
 Standard: PA6T
 Contact: Brass
 Insulator: Polyester,UL94V-0
 Electrical Characteristics:
 Rated Current: 0.75AMP
 Contact Resistance: 30mΩ Max
 Withstand Voltage: 500V AC/DC
 Insulator Resistance: 1000MΩ Min
 Mechanical
 Operating Temperature: -40°C~+105°C
 Max.Processing Temp:230°C For30-60 Seconds(260°C For10 Seconds)

Order Information:

RHTAY07G-1.00-2-XX-T-L1xL2xL3-G0

Pin Header Series
 07G:1.00mm
 Plastics Height: 1.00,1.50mm
 Per Row:Double Layer
 Pin: No. Of Pins (2~100)
 Post:T3=With Post T=W/D Post,
 Size:L1xL2xL3
 Plating:
 G0=Gold Flash G1=1u' Gold
 G10=10u' Gold G15=15u' Gold
 G30=30u' Gold

RHTECP NINGBO RHT ELECTRONIC CO.,LTD

UNITS:mm	SHEET SIZE: A4	SCALE:---	DRWN BY PAN
0~3	3~18	18~50	50~120
±0.12	±0.15	±0.3	±0.5
CHK'D BY FENG		APPR BY ZHAN	

1.00mm Pin Header Double Layer,SMT,2xN Pin

THIRD ANGLE PROJECTION



RHTAY07G-1.00-2-XX-T-L1xL2xL3-G0