

RoHS Compliance

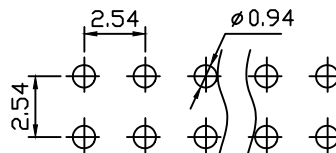

Recommended P.C.B Hole Layout

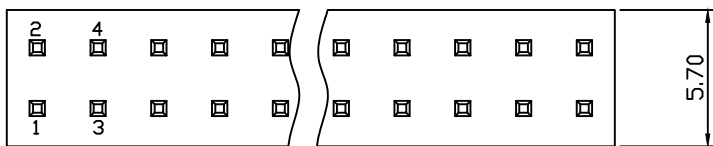
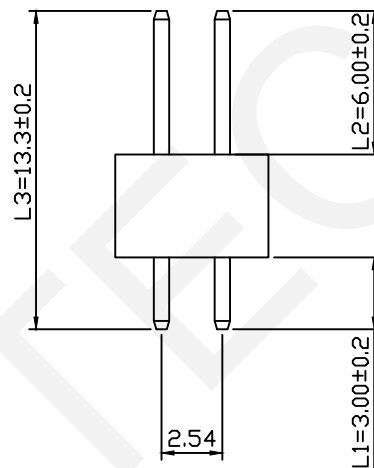
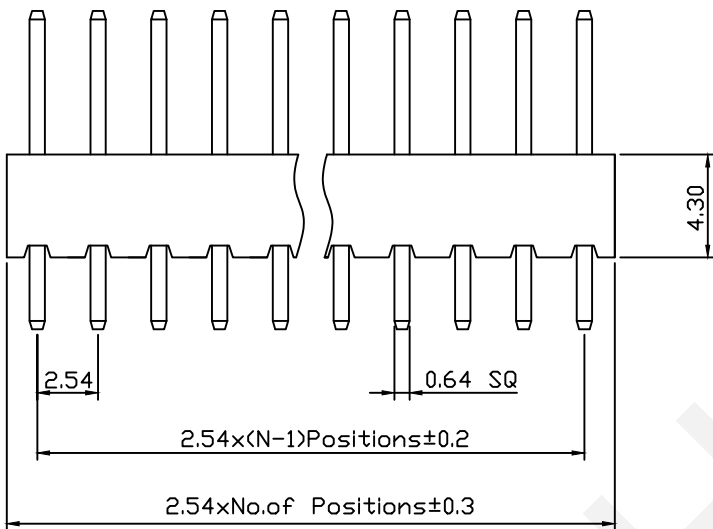

Material:
 Standard: PA6T/UL94V-0
 Contact: Brass
 Electrical Characteristics:
 Rated Current: 3AMP
 Contact Resistance: 20mΩ Max
 Withstand Voltage: 1000V AC/DC
 Insulator Resistance: 1000MΩ Min
 Withstanding Voltage: AC 500V
 Mechanical
 Operating Temperature: -40°C~+105°C

Order Information:

RHTAY07L-2-XX-S-L1xL2xL3-G0

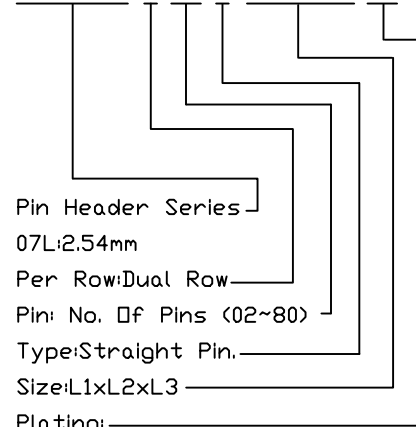

Plating:
 G0=Gold Flash G1=1u' Gold
 G10=10u' Gold G15=15u' Gold
 G30=30u' Gold

| Dimension Antitheses List (mm) | | | | |
|--------------------------------|------|------|-------|----------------|
| ITEM | L1 | L2 | L3 | Plastic Height |
| Standard | 3.00 | 6.00 | 13.30 | 4.30 |
| Nonstandard | --- | --- | --- | --- |

| | | | |
|---------------|----------------|--------------|-------------|
| UNITS:mm | SHEET SIZE: A4 | SCALE:--- | DRWN BY PAN |
| 0~3 | 3~18 | 18~50 | 50~120 |
| ±0.12 | ±0.15 | ±0.3 | ±0.5 |
| CHK'D BY FENG | | APPR BY ZHAN | |

| | |
|--|-----------------------------|
| 2.54x4.3 Pin Header Dual Row, Straight Pin, 2xN Pin | |
| THIRD ANGLE PROJECTION | RHTAY07L-2-XX-S-L1xL2xL3-G0 |



NINGBO RHT ELECTRONIC CO.,LTD

2.54x4.3 Pin Header
Dual Row, Straight Pin, 2xN Pin

THIRD ANGLE PROJECTION

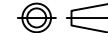

RHTAY07L-2-XX-S-L1xL2xL3-G0

RoHS Compliance

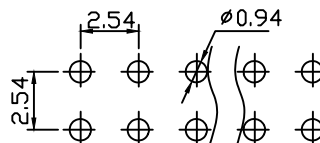
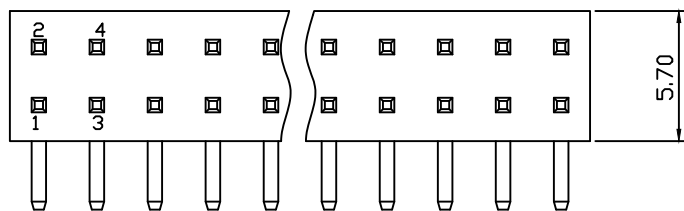

Recommended P.C.B Hole Layout

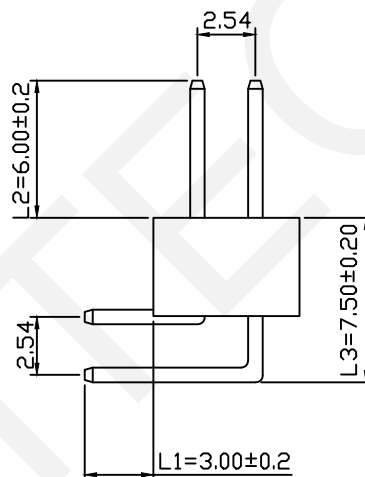
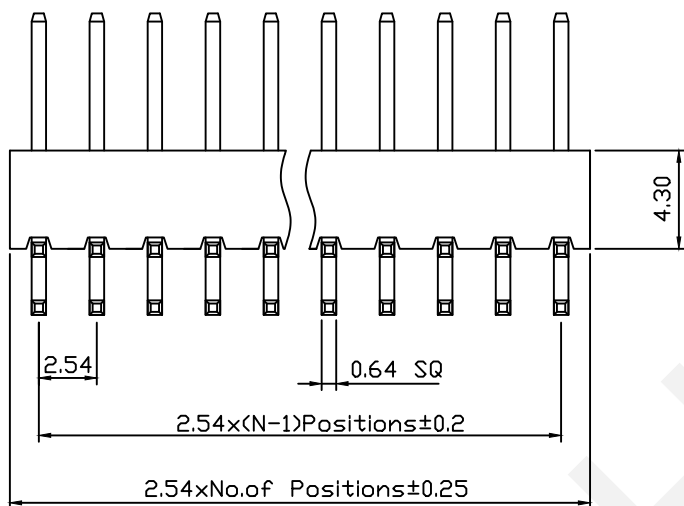

Material:
 Standard: PA6T/UL94V-0
 Contact: Brass
 Electrical Characteristics:
 Rated Current: 3AMP
 Contact Resistance: 20mΩ Max
 Withstand Voltage: 1000V AC/DC
 Insulator Resistance: 1000MΩ Min
 Withstanding Voltage: AC 500V
 Mechanical
 Operating Temperature: -40°C~+105°C

Order Information:
RHTAY07L-2-XX-R-L1xL2xL3-G0

Pin Header Series
 07L:2.54mm
 Per Row: Dual Row
 Pin: No. Of Pins (02~80)
 Type: Right Angle Pin
 Size: L1xL2xL3
 Plating:
 G0=Gold Flash G1=1u" Gold
 G10=10u" Gold G15=15u" Gold
 G30=30u" Gold

| Dimension Antitheses List (mm) | | | | |
|--------------------------------|------|------|------|----------------|
| ITEM | L1 | L2 | L3 | Plastic Height |
| Standard | 3.00 | 6.00 | 7.50 | 4.30 |
| Nonstandard | --- | --- | --- | --- |

RHTECP NINGBO RHT ELECTRONIC CO.,LTD

| UNITS:mm | SHEET SIZE: A4 | | SCALE:--- | DRWN BY PAN |
|----------|----------------|-------|-----------|---------------|
| 0~3 | 3~18 | 18~50 | 50~120 | CHK'D BY FENG |
| ±0.12 | ±0.15 | ±0.3 | ±0.5 | APPR BY ZHAN |

2.54x4.3 Pin Header
 Dual Row, Right Angle Pin, 2xN Pin
 THIRD ANGLE PROJECTION
 RHTAY07L-2-XX-R-L1xL2xL3-G0

RoHS Compliance

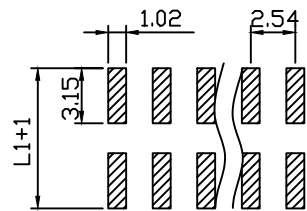
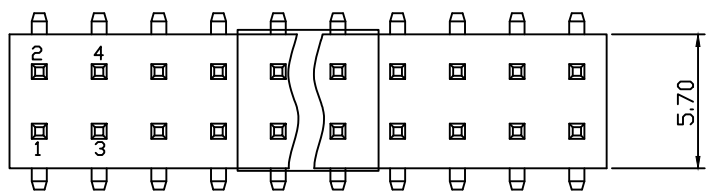

Recommended P.C.B Hole Layout

Material:
 Standard: PA6T/UL94V-0
 Contact: Brass
 Electrical Characteristics:
 Rated Current: 3AMP
 Contact Resistance: 20mΩ Max
 Withstand Voltage: 1000V AC/DC
 Insulator Resistance: 1000MΩ Min
 Withstanding Voltage: AC 500V
 Mechanical
 Operating Temperature: -40°C~+105°C

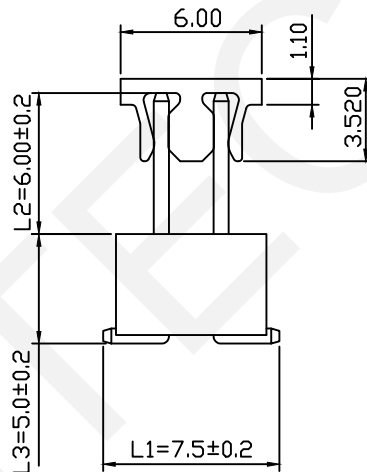
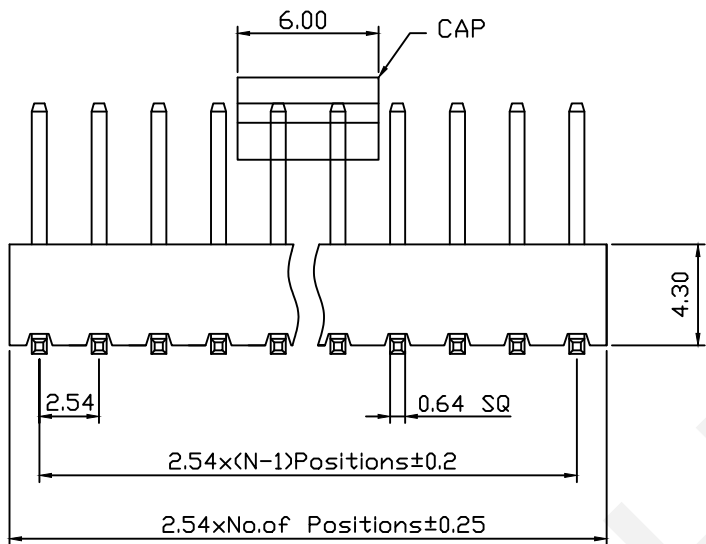

Order Information:
RHTAY07L-2-XX-T-L1xL2xL3-G0

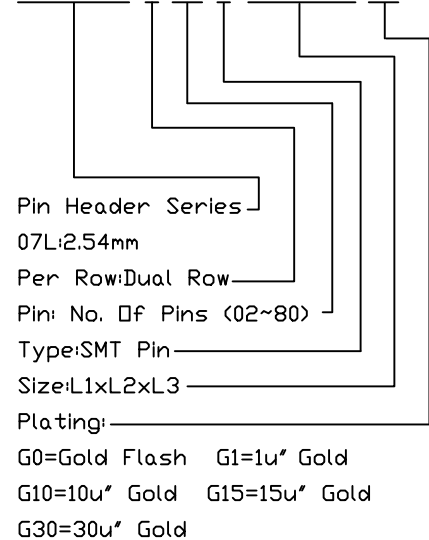

| Dimension Antitheses List (mm) | | | | |
|--------------------------------|------|------|------|----------------|
| ITEM | L1 | L2 | L3 | Plastic Height |
| Standard | 7.50 | 6.00 | 5.00 | 4.30 |
| Nonstandard | --- | --- | --- | --- |

RHTECP NINGBO RHT ELECTRONIC CO.,LTD

UNITS:mm SHEET SIZE: A4 SCALE:--- DRWN BY PAN
 0~3 3~18 18~50 50~120 CHK'D BY FENG
 ±0.12 ±0.15 ±0.3 ±0.5 APPR BY ZHAN

2.54x4.3 Pin Header
 Dual Row,SMT Pin, 2xN Pin
 THIRD ANGLE PROJECTION
 RHTAY07L-2-XX-T-L1xL2xL3-G0