

RoHS Compliance

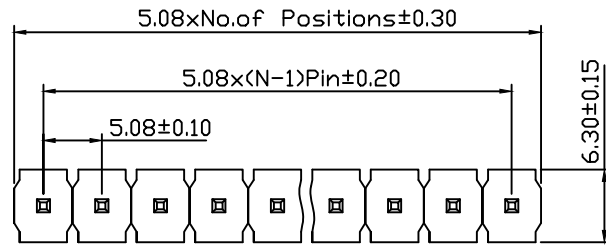

Recommended P.C.B Layout(Top Side)
(PCB BOARD TOLERANCE±0.05)

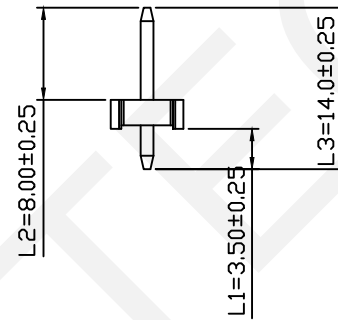
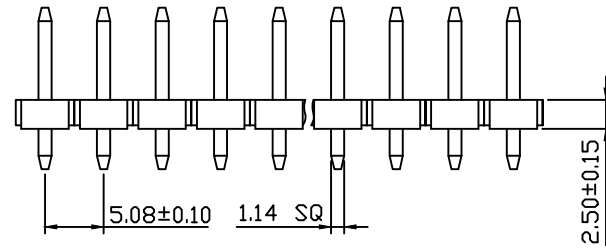
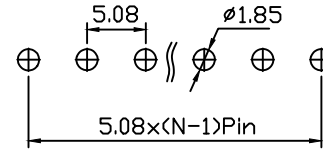

Material:
Standard: LCP
Contact: Brass
Insulator: Polyester,UL94V-0
Electrical Characteristics:
Current Rating : 7AMP
Contact Resistance: 20MΩ Max
Withstand Voltage: 1000V AC
Insulator Resistance: 1000MΩ Min
Mechanical
Operating Temperature:-40°C~+105°C
Max.Processing Temp:230°C For 30-60
Seconds (260°C For 10 Seconds)

Order Information:
RHTAY07M-2.50-1-XX-S-L1xL2xL3-SN

Pin Header Series
07M: 5.08mm
Plastics Height: 2.50,3.00mm
Per Row:Single Layer
Pin: No. Of Pins (1x20)
Type: Straight Pin
Size:L1xL2xL3
Plating:
G0=Gold Flash G1=1u" Gold
G10=10u" Gold G15=15u" Gold
G30=30u" Gold SN=Tin

Dimension Antitheses List (mm)				
ITEM	L1	L2	L3	Plastic Height
Standard	3.50	8.00	14.0	2.50
Nonstandard	---	---	---	---

RHTECP NINGBO RHT ELECTRONIC CO.,LTD

UNITS:mm SHEET SIZE: A4 SCALE:--- DRWN BY PAN
0~3 3~18 18~50 50~120 CHK'D BY FENG
±0.12 ±0.15 ±0.3 ±0.5 APPR BY ZHAN

5.08x2.5 Pin Header
Single Layer, Straight Pin, 1xN Pin
THIRD ANGLE PROJECTION
RHTAY07M-2.50-1-XX-S-L1xL2xL3-SN

RoHS Compliance

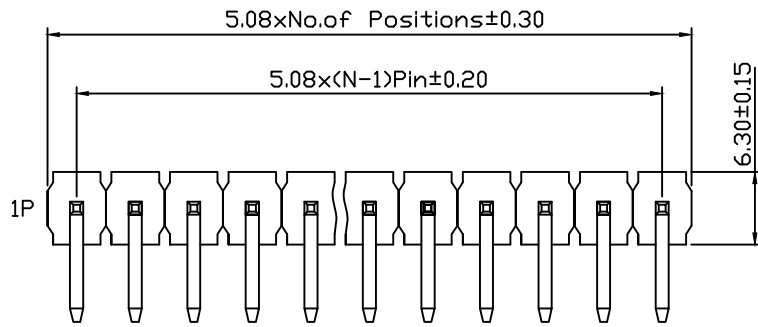

Recommended P.C.B Layout (Top Side)
(PCB BOARD TOLERANCE ± 0.05)

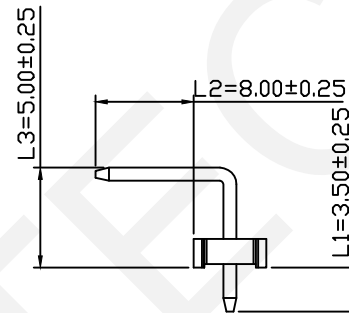
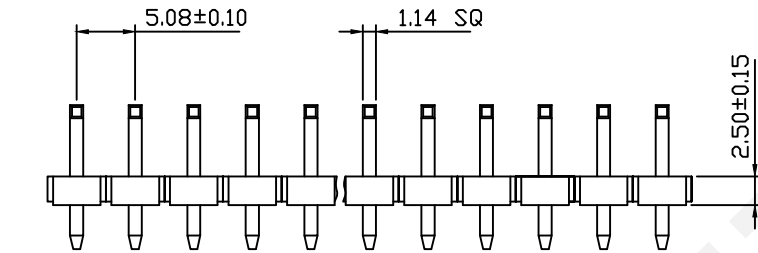
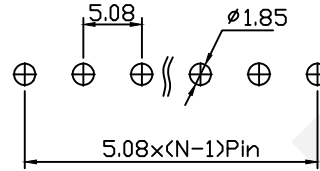

R1 Type

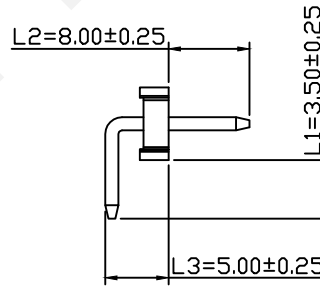

R2 Type

Dimension Antitheses List (mm)				
ITEM	L1	L2	L3	Plastic Height
Standard	3.50	8.00	5.00	2.50
Nonstandard	---	---	---	---

Material:
Standard: PA6T
Contact: Brass
Insulator: Polyester, UL94V-0
Electrical Characteristics:
Current Rating : 7AMP
Contact Resistance: 20MΩ Max
Withstand Voltage: 1000V AC
Insulator Resistance: 1000MΩ Min
Mechanical
Operating Temperature: -40°C ~ +105°C
Max. Processing Temp: 230°C For 30-60 Seconds (260°C For 10 Seconds)

Order Information:
RHTAY07M-2.50-1-XX-R1-L1xL2xL3-SN

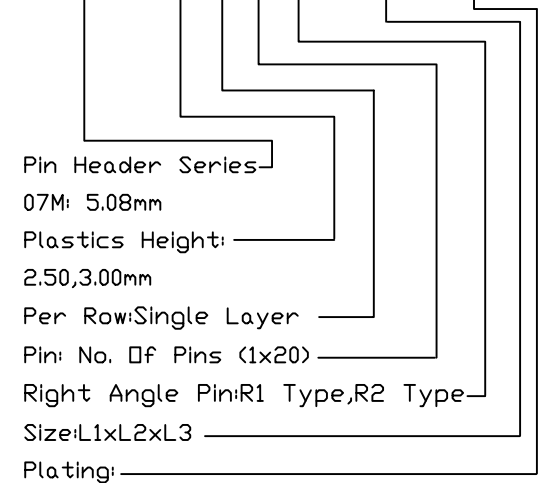

Plating:
G0=Gold Flash G1=1u" Gold
G10=10u" Gold G15=15u" Gold
G30=30u" Gold SN=Tin



NINGBO RHT ELECTRONIC CO.,LTD

UNITS:mm	SHEET SIZE: A4	SCALE:---	DRWN BY PAN
0~3	3~18	18~50	50~120
±0.12	±0.15	±0.3	±0.5
CHK'D BY FENG		APPR BY ZHAN	

5.08x2.5 Pin Header Single Layer, Right Angle Pin, 1xN Pin	
THIRD ANGLE PROJECTION 	RHTAY07M-2.50-1-XX-R1-L1xL2xL3-SN

RoHS Compliance

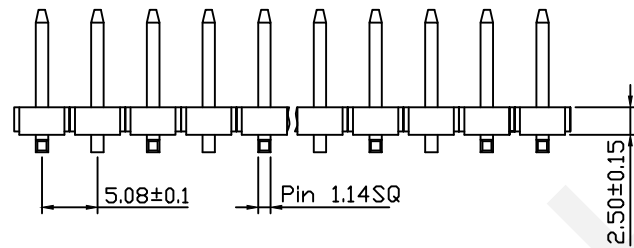
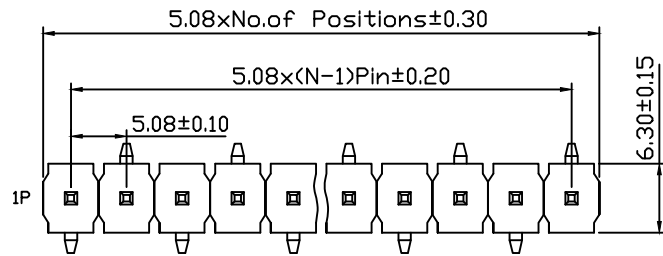
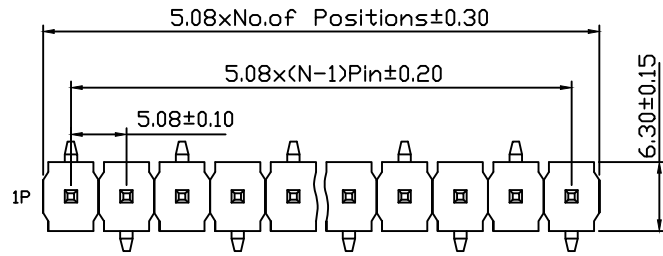

Recommended P.C.B Layout(Top Side)
(PCB BOARD TOLERANCE±0.05)

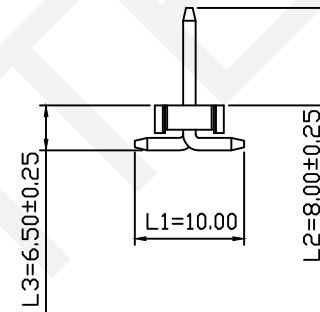
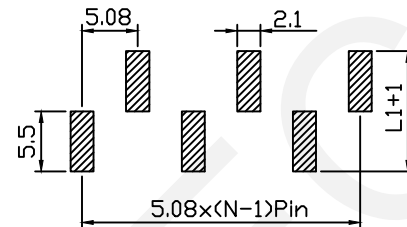
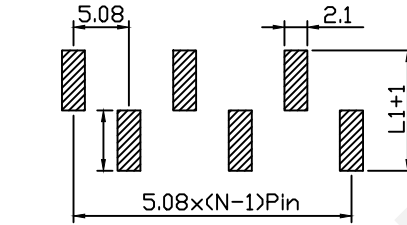

Dimension Antitheses List (mm)				
ITEM	L1	L2	L3	Plastic Height
Standard	10.00	8.00	6.50	2.50
Nonstandard	---	---	---	---

Material:
Standard: LCP
Contact: Brass
Insulator: Polyester,UL94V-0
Electrical Characteristics:
Current Rating : 7AMP
Contact Resistance: 20MΩ Max
Withstand Voltage: 1000V AC
Insulator Resistance: 1000MΩ Min
Mechanical
Operating Temperature:-40°C~+105°C
Max.Processing Temp:230°C For 30-60 Seconds (260°C For 10 Seconds)

Order Information:
RHTAY07M-2.50-1-XX-T1-L1xL2xL3-SN

Pin Header Series
07M: 5.08mm
Plastics Height:
2.50,3.00mm
Per Row:Single Layer
Pin: No. Of Pins (1x20)
SMT Pin:T1 Type, T2 Type
Size:L1xL2xL3
Plating:
G0=Gold Flash G1=1u" Gold
G10=10u" Gold G15=15u" Gold
G30=30u" Gold SN=Tin

NINGBO RHT ELECTRONIC CO.,LTD

UNITS:mm SHEET SIZE: A4 SCALE:--- DRWN BY PAN
0~3 3~18 18~50 50~120 CHK'D BY FENG
±0.12 ±0.15 ±0.3 ±0.5 APPR BY ZHAN

5.08x2.5 Pin Header
Single Layer,SMT, 1xN Pin
THIRD ANGLE PROJECTION
 RHTAY07M-2.50-1-XX-T1-L1xL2xL3-SN