

RoHS Compliance

02P~03P

04P~06P

07P~15P

Circuit 1

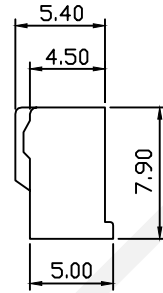
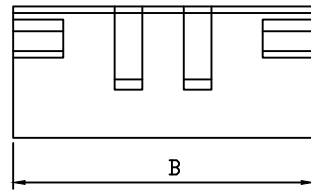
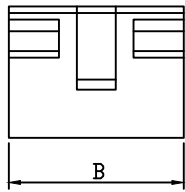
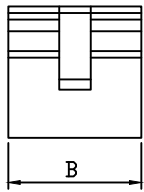
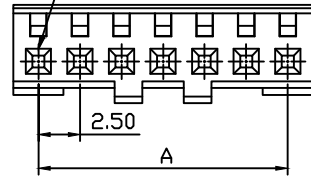
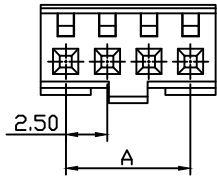
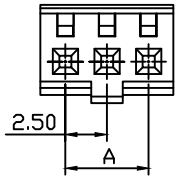

TYPE 1

Pin	Dimension(mm)	
	A	B
02	2.50	5.50
03	5.00	8.00
04	7.50	10.50
05	10.00	13.00
06	12.50	15.50
07	15.00	18.00
08	17.50	20.50
09	20.00	23.00
10	22.50	25.50
11	25.00	28.00
12	27.50	30.50
13	30.00	33.00
14	32.50	35.50
15	35.00	38.00

Material:

Housing: PA66,UL94V-0

Electrical Characteristics:

Current Rating : 3.0A AC,DC

Voltage Rating : 500V AC,DC

Temperature Range:-25°C~+85°C

Insulator Resistance: 100MΩ/Min.

Withstanding Voltage: 1500V AC/Minute

Contact Resistance: 20MΩ/Max

Order Information:

RHTAYL1-2.50-XX-H

Pitch:2.50mm

XX-No.of 02~15Pin

Type:

T-Terminal H-Hosing

S-Straight Male Pin

R-Right Angle Male Pin

13P~15P

Circuit 1

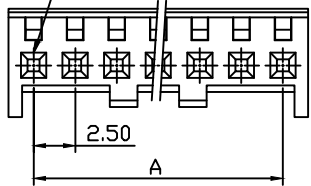

TYPE 2

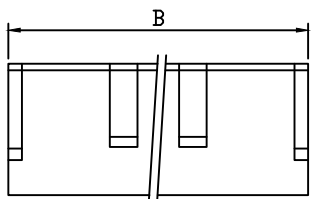
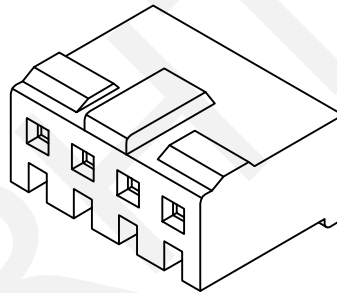
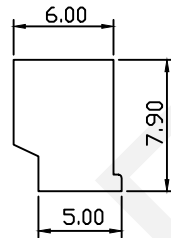

NINGBO RHT ELECTRONIC CO.,LTD

UNITS:mm	SHEET SIZE: A4	SCALE:---	DRWN BY PAN
0~3	3~18	18~50	50~120
±0.12	±0.15	±0.3	±0.5
			CHK'D BY FENG
			APPR BY ZHAN

2.50mm Pitch IL-G Type  
Wire To Board Connector

THIRD ANGLE PROJECTION

RHTAYL1-2.50-XX-H

RoHS Compliance

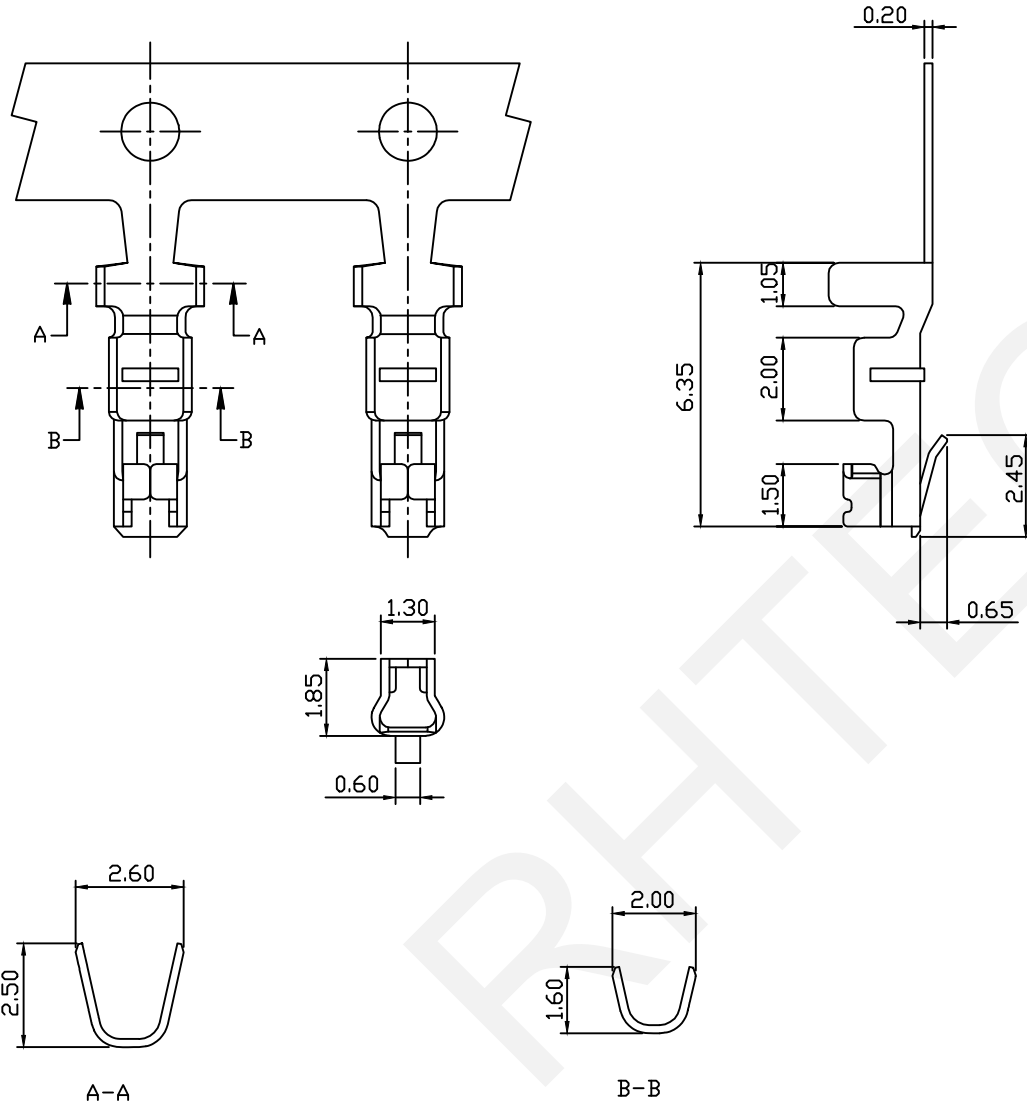

Material:  
 Terminal: Phosphor Bronze  
 Plating: Tin plated  
 Applicable Wires: AWG #22~#28  
 Insulation  $\varnothing$ : 1.7mm  
 Qty/Reel: 10000 PCS

Electrical Characteristics:  
 Current Rating : 3.0A AC,DC  
 Voltage Rating : 500V AC,DC  
 Temperature Range: -25°C~+85°C  
 Insulator Resistance: 100M $\Omega$ /Min.  
 Withstanding Voltage: 1500V AC/Minute  
 Contact Resistance: 20M $\Omega$ /Max

Order Information:  
 RHTAYL1-2.50-T

Pitch: 2.50mm  
 Type:   
 T-Terminal H-Hosing  
 S-Straight Male Pin  
 R-Right Angle Male Pin

NINGBO RHT ELECTRONIC CO.,LTD

UNITS:mm	SHEET SIZE: A4	SCALE:---	DRWN BY PAN
0~3	3~18	18~50	50~120
±0.12	±0.15	±0.3	±0.5

CHK'D BY FENG  
 APPR BY ZHAN

2.50mm Pitch IL-G Type  
 Wire To Board Connector  
 THIRD ANGLE PROJECTION  
 RHTAYL1-2.50-T

RoHS Compliance

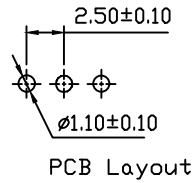
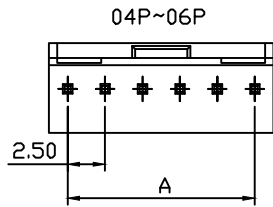
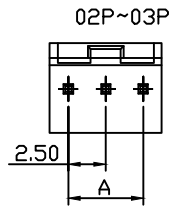

Pin	Dimension(mm)	
	A	B
02	2.50	5.00
03	5.00	7.50
04	7.50	10.00
05	10.00	12.50
06	12.50	15.00
07	15.00	17.50
08	17.50	20.00
09	20.00	22.50
10	22.50	25.00
11	25.00	27.50
12	27.50	30.00
13	30.00	32.50
14	32.50	35.00
15	35.00	37.50

Material:

Housing: PA66,UL94V-0

Contact:Brass

Plating: Tin plate

Electrical Characteristics:

Current Rating : 3.0A AC,DC

Voltage Rating : 500V AC,DC

Temperature Range:-25°C~+85°C

Insulator Resistance: 100MΩ/Min.

Withstanding Voltage: 1500V AC/Minute

Contact Resistance: 20MΩ/Max

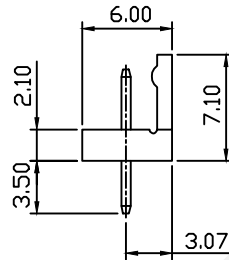
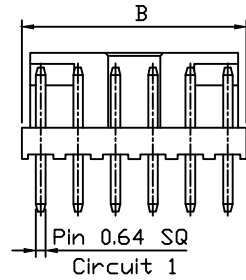
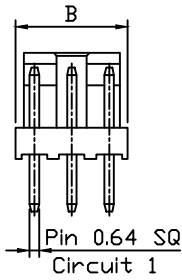

07P~15P

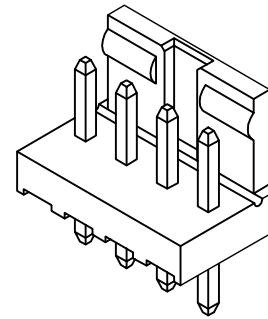
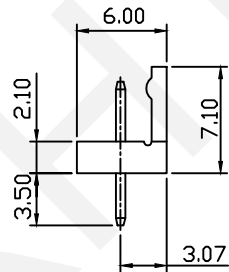
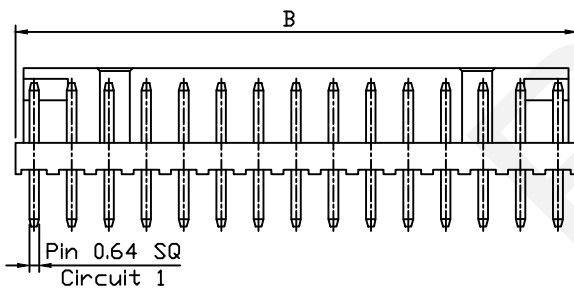
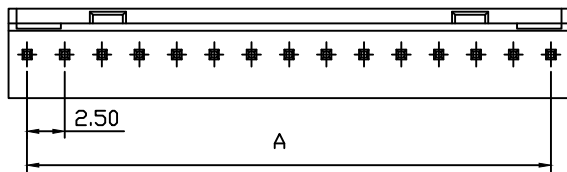

Order Information:

RHTAYL1-2.50-XX-S

Pitch:2.50mm

XX-No.of 02~15Pin

Type:

T-Terminal H-Hosing

S-Straight Male Pin

R-Right Angle Male Pin



NINGBO RHT ELECTRONIC CO.,LTD

UNITS:mm SHEET SIZE: A4 SCALE:---

0~3 3~18 18~50 50~120

±0.12 ±0.15 ±0.3 ±0.5

DRWN BY PAN

CHK'D BY FENG

APPR BY ZHAN

2.50mm Pitch IL-G Type  
Wire To Board Connector

THIRD ANGLE PROJECTION

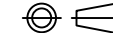

RHTAYL1-2.50-XX-S

RoHS Compliance

02P~03P

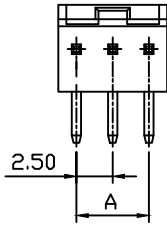

04P~06P

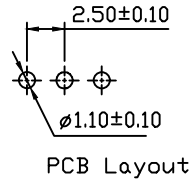
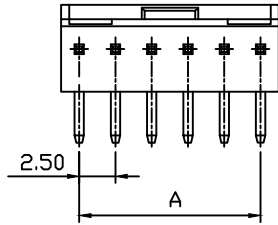

Pin	Dimension(mm)	
	A	B
02	2.50	5.00
03	5.00	7.50
04	7.50	10.00
05	10.00	12.50
06	12.50	15.00
07	15.00	17.50
08	17.50	20.00
09	20.00	22.50
10	22.50	25.00
11	25.00	27.50
12	27.50	30.00
13	30.00	32.50
14	32.50	35.00
15	35.00	37.50

Material:

Housing: PA66,UL94V-0

Contact:Brass

Plating: Tin plate

Electrical Characteristics:

Current Rating : 3.0A AC,DC

Voltage Rating : 500V AC,DC

Temperature Range:-25°C~+85°C

Insulator Resistance: 100MΩ/Min.

Withstanding Voltage: 1500V AC/Minute

Contact Resistance: 20MΩ/Max

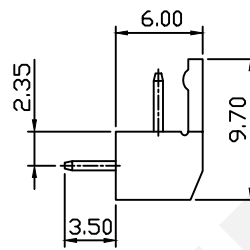
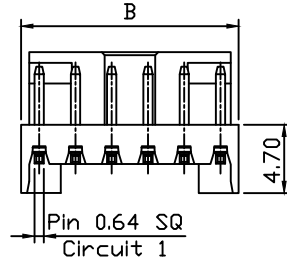
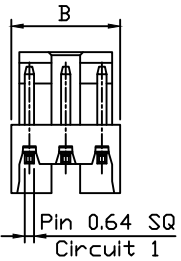

07P~15P

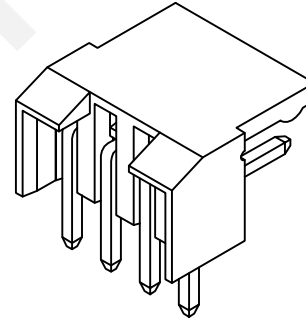
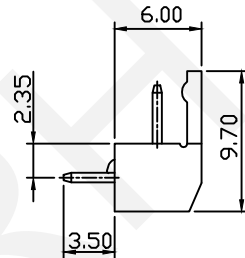
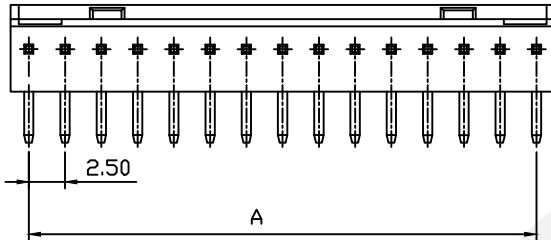

Order Information:

RHTAYL1-2.50-XX-R

Pitch:2.50mm

XX-No.of 02~15Pin

Type:

T-Terminal H-Hosing

S-Straight Male Pin

R-Right Angle Male Pin

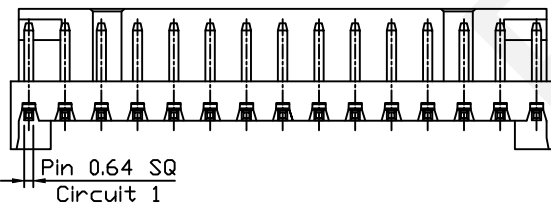

**RHTECP** NINGBO RHT ELECTRONIC CO.,LTD

UNITS:mm	SHEET SIZE: A4	SCALE:---	DRWN BY PAN
0~3	3~18	18~50	50~120
±0.12	±0.15	±0.3	±0.5
			CHK'D BY FENG
			APPR BY ZHAN

THIRD ANGLE PROJECTION



2.50mm Pitch IL-G Type  
Wire To Board Connector

RHTAYL1-2.50-XX-R