

RoHS Compliance

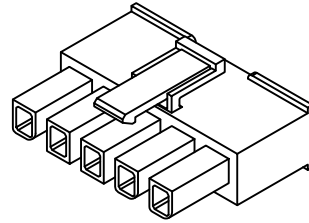

Material:
Housing: PA66,UL94V-0/2

Electrical Characteristics:
Rated Current : 7.0A AC DC
Voltage Rating : 600V AC,DC
Temperature Range: -25°C~+85°C
Insulator Resistance: 1000MΩ/Min.
Withstanding Voltage: 1500V AC/Minute
Contact Resistance: 20MΩ/Max

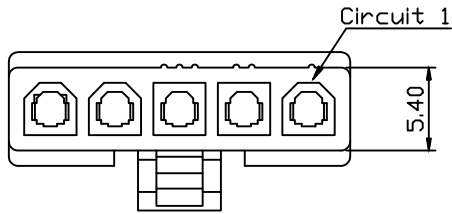
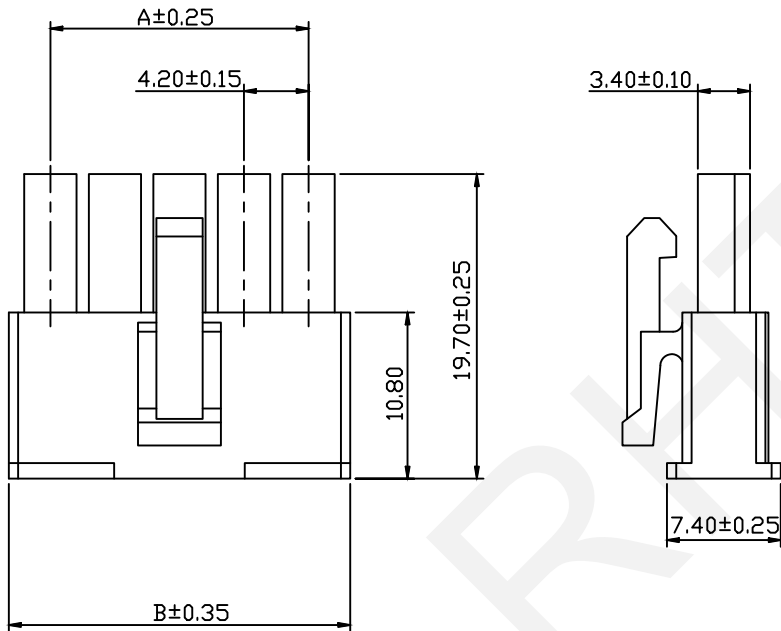

Pin	Dimension(mm)	
	A	B
02	4.20	9.60
03	8.40	13.80
04	12.60	18.00
05	16.80	22.20
06	21.00	26.40

Order Information:
RHTAY4.20-1x02-MH

Pitch: 4.20mm
Pins: _____
1-Single Layer
2-Double Layer
No.of 02~06 Pins _____
Type: _____
MH/FH -Hosing
MT/FT-Terminal
W1-Without Ear

 NINGBO RHT ELECTRONIC CO.,LTD

UNITS:mm SHEET SIZE: A4 SCALE:--- DRWN BY PAN
0~3 3~18 18~50 50~120 CHK'D BY FENG
±0.12 ±0.15 ±0.3 ±0.5 APPR BY ZHAN

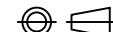
4.20mm Pitch Mini-Fit JR 5556 5557
5559 5566 5569 Wire To Board Connector
THIRD ANGLE PROJECTION
 RHTAY4.20-1x02-MH

RoHS Compliance

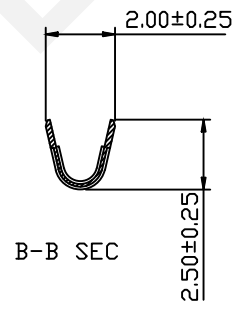
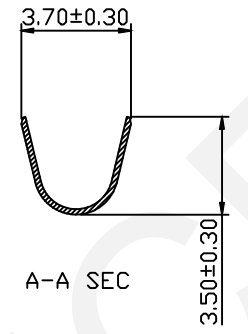
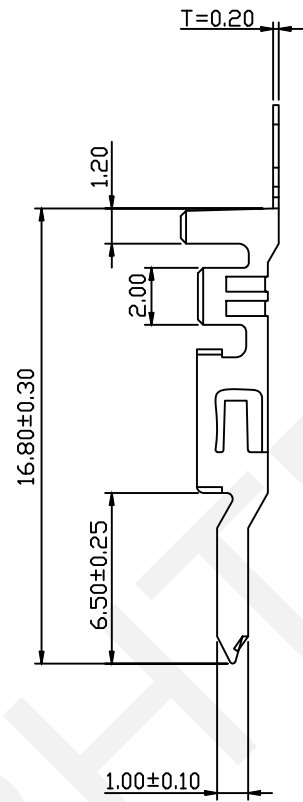
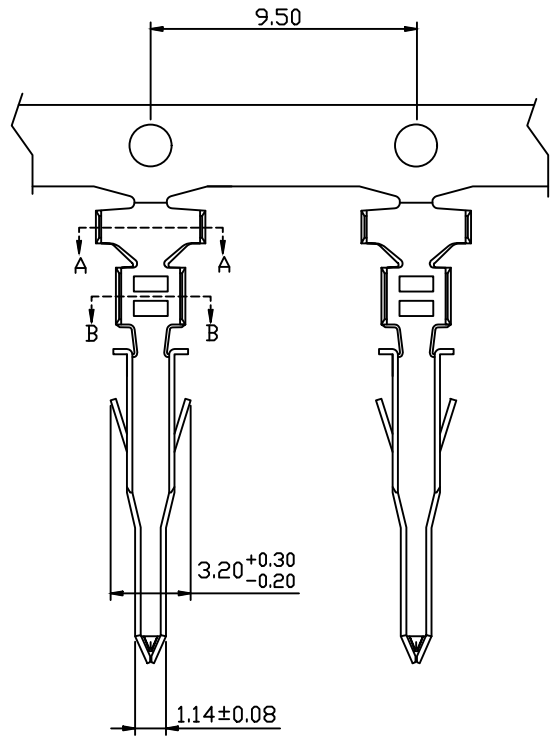

Material:
Terminal: Brass
Finish: Tin plated
Applicable Wire: AWG #20-#24

Electrical Characteristics:
Rated Current : 7.0A AC,DC
Voltage Rating : 600V AC,DC
Temperature Range: -25°C~+85°C
Insulator Resistance: 1000MΩ/Min.
Withstanding Voltage: 1500V AC/Minute
Contact Resistance: 20MΩ/Max

Order Information:
RHTAY4.20-MT
Pitch: 4.20mm
Type: _____
MH/FH -Hosing
MT/FT-Terminal
W1-Without Ear

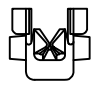

RHTECP NINGBO RHT ELECTRONIC CO.,LTD

UNITS:mm	SHEET SIZE: A4				SCALE:---	DRWN BY PAN
0~3	3~18	18~50	50~120	CHK'D BY FENG	4.20mm Pitch Mini-Fit JR 5556 5557 5559 5566 5569 Wire To Board Connector	
±0.12	±0.15	±0.3	±0.5	APPR BY ZHAN	THIRD ANGLE PROJECTION	RHTAY4.20-MT



RHTAY4.20-MT

RoHS Compliance

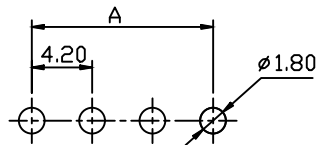
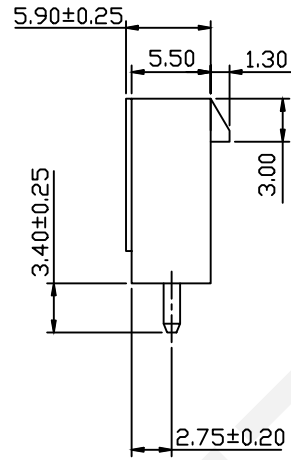
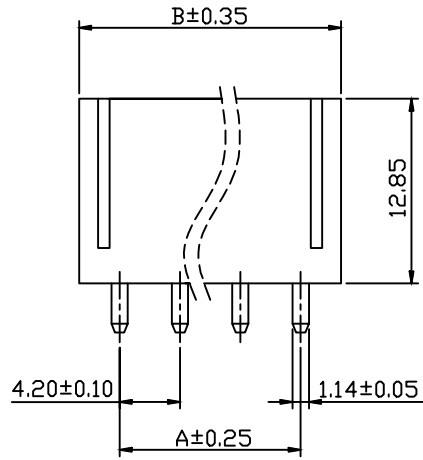
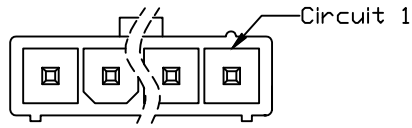

Recommended P.C.B Layout

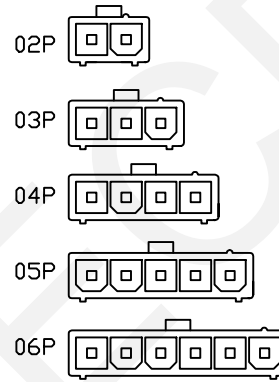
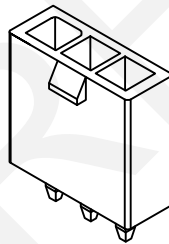

Circuit Size Layout

Pin	Dimension(mm)	
	A	B
02	4.20	9.60
03	8.40	13.80
04	12.60	18.00
05	16.80	22.20
06	21.00	26.40

Material:

Housing: PA66,UL94V-0/2

Contacts:Brass

Finish:Tin-Plated Or Gold-Flash

Electrical Characteristics:

Rated Current : 7.0A AC DC

Voltage Rating : 600V AC,DC

Temperature Range: -25°C~+85°C

Insulator Resistance: 1000MΩ/Min.

Withstanding Voltage: 1500V AC/Minute

Contact Resistance: 20MΩ/Max

Order Information:

RHTAY4.20-1x02-S

Pitch:4.20mm

Pins: _____

1-Single Layer

2-Double Layer

No.of 02~06 Pins _____

Type: _____

S/SW/SB-Straight Male Pin

R/RW/RB-Right Angle Male Pin

RHTECP NINGBO RHT ELECTRONIC CO.,LTD

UNITS:mm	SHEET SIZE: A4	SCALE:---	DRWN BY PAN
0~3	3~18	18~50	50~120
±0.12	±0.15	±0.3	±0.5
CHK'D BY FENG		APPR BY ZHAN	

4.20mm Pitch Mini-Fit JR 5556 5557
5559 5566 5569 Wire To Board Connector

THIRD ANGLE PROJECTION



RHTAY4.20-1x02-S

RoHS Compliance

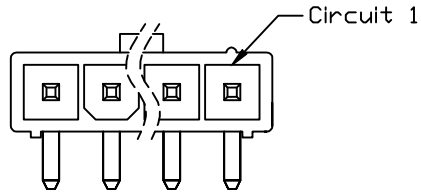

Material:
 Housing: PA66,UL94V-0/2
 Contacts:Brass
 Finish:Tin-Plated Or Gold-Flash

Electrical Characteristics:
 Rated Current : 7.0A AC DC
 Voltage Rating : 600V AC,DC
 Temperature Range: -25°C~+85°C
 Insulator Resistance: 1000MΩ/Min.
 Withstanding Voltage: 1500V AC/Minute
 Contact Resistance: 20MΩ/Max

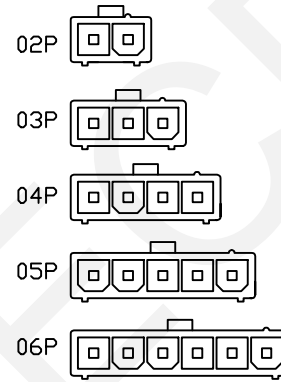
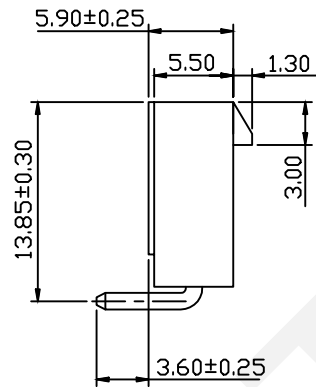
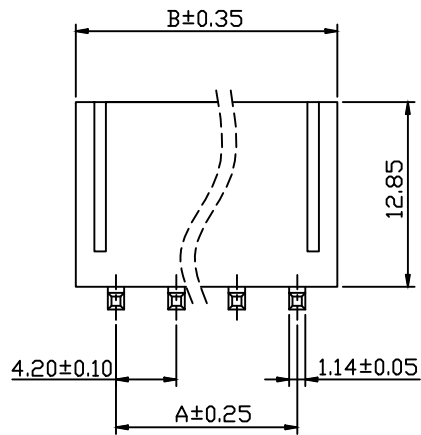

Circuit Size Layout

Order Information:

RHTAY4.20-1x02-R

Pitch:4.20mm

Pins:

1-Single Layer

2-Double Layer

No.of 02~06 Pins

Type:

S/SW/SB-Straight Male Pin

R/RW/RB-Right Angle Male Pin

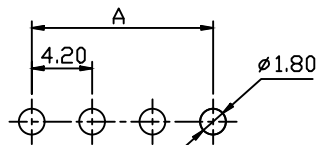

Recommended P.C.B Layout

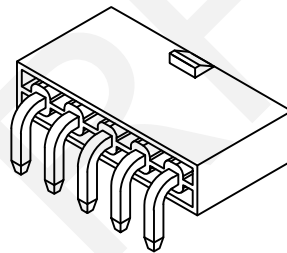

Pin	Dimension(mm)	
	A	B
02	4.20	9.80
03	8.40	14.00
04	12.60	18.20
05	16.80	22.40
06	21.00	26.60

RHTECP NINGBO RHT ELECTRONIC CO.,LTD

UNITS:mm	SHEET SIZE: A4	SCALE:---	DRWN BY PAN
0~3	3~18	18~50	50~120
±0.12	±0.15	±0.3	±0.5
CHK'D BY FENG		APPR BY ZHAN	

4.20mm Pitch Mini-Fit JR 5556 5557
 5559 5566 5569 Wire To Board Connector
 THIRD ANGLE PROJECTION
 RHTAY4.20-1x02-R

RoHS Compliance

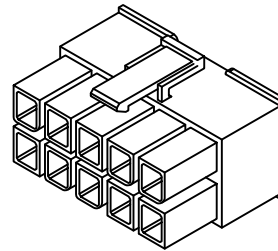
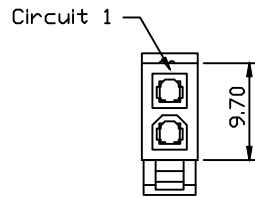
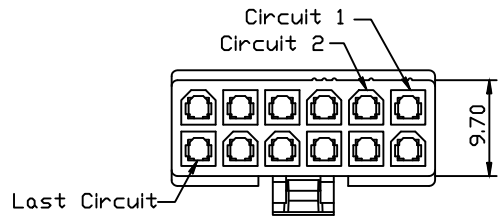

Material:
Housing: PA66,UL94V-0/2

Electrical Characteristics:
Rated Current : 7.0A AC DC
Voltage Rating : 600V AC,DC
Temperature Range: -25°C~+85°C
Insulator Resistance: 1000MΩ/Min.
Withstanding Voltage: 1500V AC/Minute
Contact Resistance: 20MΩ/Max

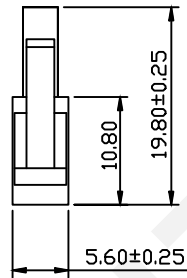
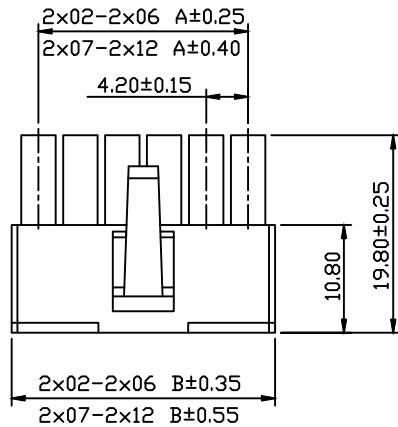

Pin	Dimension(mm)	
	A	B
2x01	---	5.60
2x02	4.20	9.80
2x03	8.40	14.00
2x04	12.60	18.20
2x05	16.80	22.40
2x06	21.00	26.60
2x07	25.20	30.80
2x08	29.40	35.00
2x09	33.60	39.20
2x10	37.80	43.40
2x11	42.00	47.60
2x12	46.20	51.80

Order Information:

RHTAY4.20-2x02-MH

Pitch: 4.20mm

Pins: _____

1-Single Layer

2-Double Layer

No.of 01~12 Pins _____

Type: _____

MH/FH -Hosing

MT/FT-Terminal

W1-Without Ear

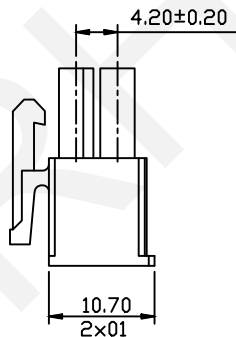
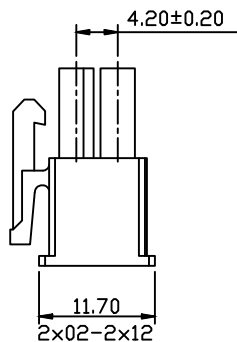

RHTECP NINGBO RHT ELECTRONIC CO.,LTD

UNITS:mm SHEET SIZE: A4 SCALE:--- DRWN BY PAN
0~3 3~18 18~50 50~120 CHK'D BY FENG
±0.12 ±0.15 ±0.3 ±0.5 APPR BY ZHAN

4.20mm Pitch Mini-Fit JR 5556 5557
5559 5566 5569 Wire To Board Connector
THIRD ANGLE PROJECTION
 RHTAY4.20-2x02-MH

RoHS Compliance

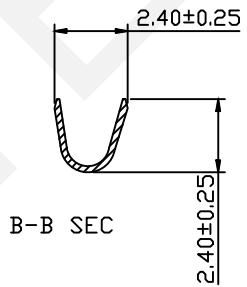
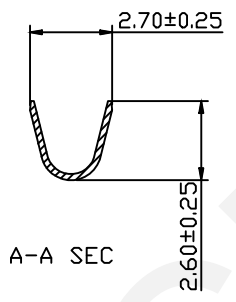
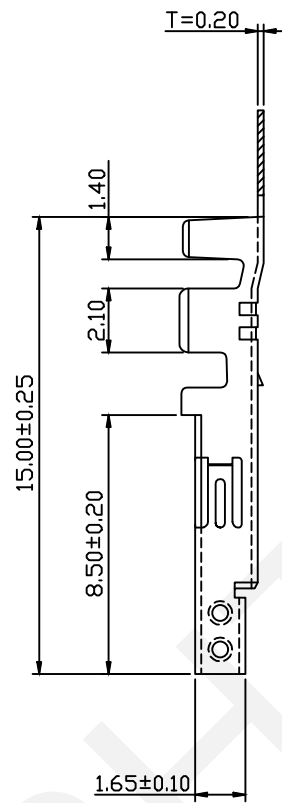
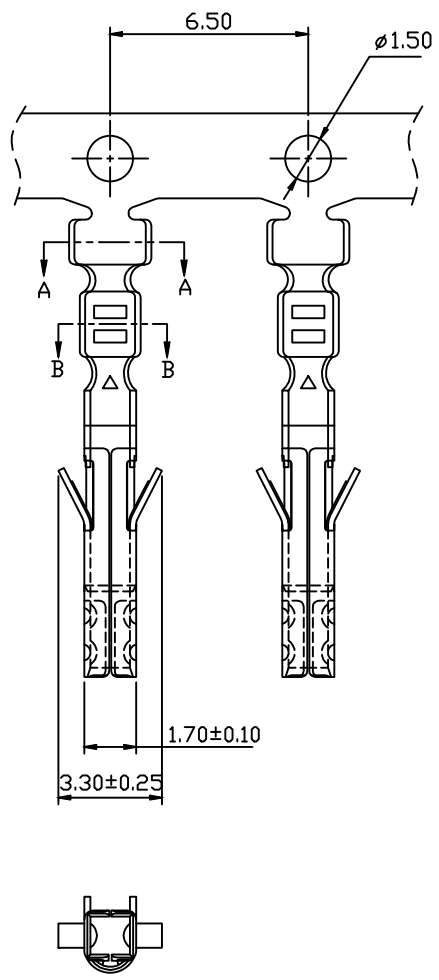

Material:
Terminal: Brass Or Phosphor Beccored
Finish: Tin plated
Applicable Wire: AWG #20-#24

Electrical Characteristics:
Rated Current : 7.0A AC,DC
Voltage Rating : 600V AC,DC
Temperature Range: -25°C~+85°C
Insulator Resistance: 1000MΩ/Min.
Withstanding Voltage: 1500V AC/Minute
Contact Resistance: 20MΩ/Max

Order Information:
RHTAY4.20-FT

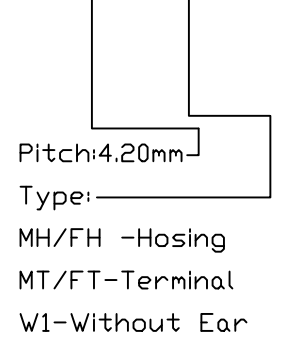

RHTECP NINGBO RHT ELECTRONIC CO.,LTD

UNITS:mm	SHEET SIZE: A4				SCALE:---	DRWN BY PAN
0~3	3~18	18~50	50~120	CHK'D BY FENG	4.20mm Pitch Mini-Fit JR 5556 5557 5559 5566 5569 Wire To Board Connector	
±0.12	±0.15	±0.3	±0.5	APPR BY ZHAN	THIRD ANGLE PROJECTION	

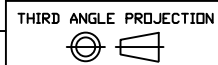

RHTAY4.20-FT

RoHS Compliance

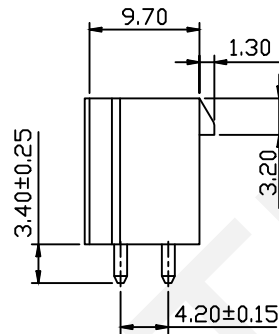
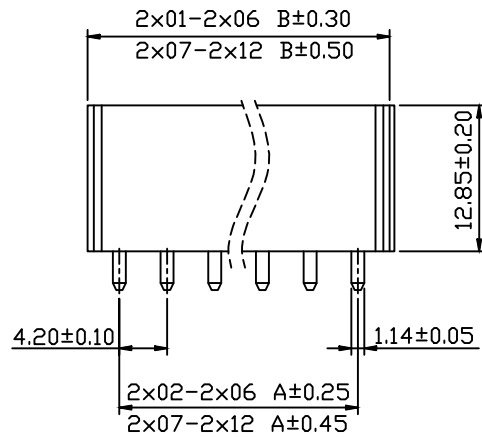
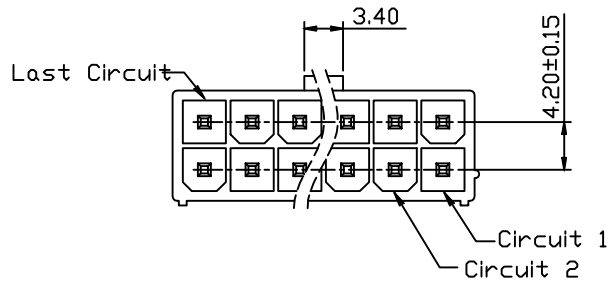

Pin	Dimension(mm)	
	A	B
2x01	---	5.60
2x02	4.20	9.80
2x03	8.40	14.00
2x04	12.60	18.20
2x05	16.80	22.40
2x06	21.00	26.60
2x07	25.20	30.80
2x08	29.40	35.00
2x09	33.60	39.20
2x10	37.80	43.40
2x11	42.00	47.60
2x12	46.20	51.80

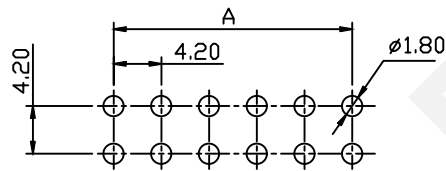

Recommended P.C.B Layout

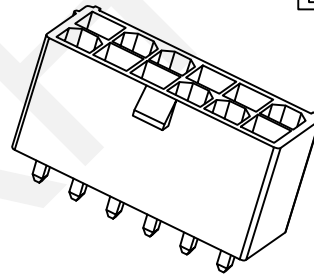

Material:
 Housing: PA66,UL94V-0/2
 Contacts:Brass
 Finish:Tin-Plated Or Gold-Flash

Electrical Characteristics:
 Rated Current : 7.0A AC DC
 Voltage Rating : 600V AC,DC
 Temperature Range: -25°C~+85°C
 Insulator Resistance: 1000MΩ/Min.
 Withstanding Voltage: 1500V AC/Minute
 Contact Resistance: 20MΩ/Max

Order Information:

RHTAY4.20-2x02-S

Pitch:4.20mm

Pins:

1-Single Layer

2-Double Layer

No.of 01~12 Pins

Type:

S/SW/SB-Straight Male Pin

R/RW/RB-Right Angle Male Pin

RHTECP NINGBO RHT ELECTRONIC CO.,LTD

UNITS:mm	SHEET SIZE: A4	SCALE:---	DRWN BY PAN
0~3	3~18	18~50	50~120
±0.12	±0.15	±0.3	±0.5

CHK'D BY FENG
 APPR BY ZHAN

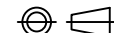
4.20mm Pitch Mini-Fit JR 5556 5557
 5559 5566 5569 Wire To Board Connector
 THIRD ANGLE PROJECTION

 RHTAY4.20-2x02-S

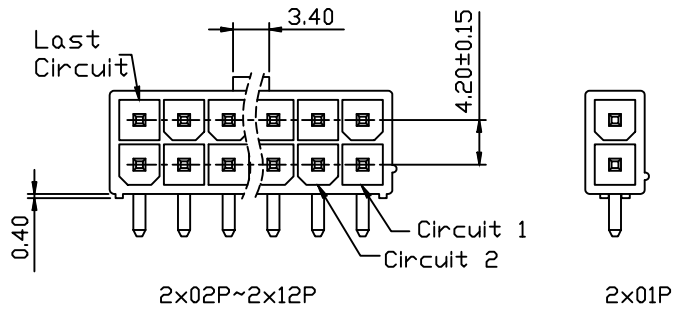
RoHS Compliance



Material:
 Housing: PA66,UL94V-0/2
 Contacts:Brass
 Finish: Tin-Plated Or Gold-Flash

Electrical Characteristics:
 Rated Current : 7.0A AC DC
 Voltage Rating : 600V AC,DC
 Temperature Range: -25°C~+85°C
 Insulator Resistance: 1000MΩ/Min.
 Withstanding Voltage: 1500V AC/Minute
 Contact Resistance: 20MΩ/Max

Order Information:

RHTAY4.20-2x02-R

Pitch:4.20mm

Pins: _____

1-Single Layer

2-Double Layer

No.of 01~12 Pins _____

Type: _____

S/SW/SB-Straight Male Pin

R/RW/RB-Right Angle Male Pin

Pin	Dimension(mm)	
	A	B
2x01	---	5.60
2x02	4.20	9.80
2x03	8.40	14.00
2x04	12.60	18.20
2x05	16.80	22.40
2x06	21.00	26.60
2x07	25.20	30.80
2x08	29.40	35.00
2x09	33.60	39.20
2x10	37.80	43.40
2x11	42.00	47.60
2x12	46.20	51.80

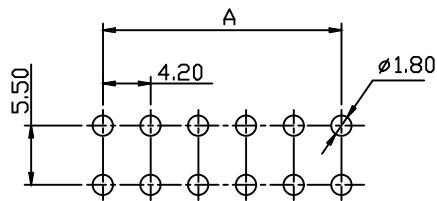
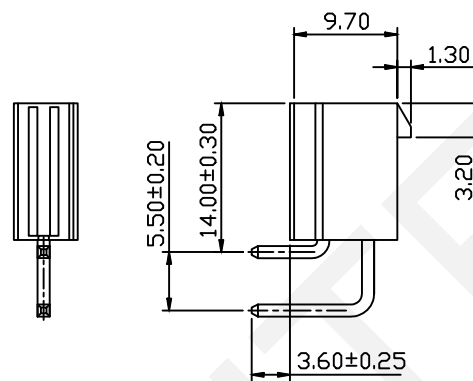
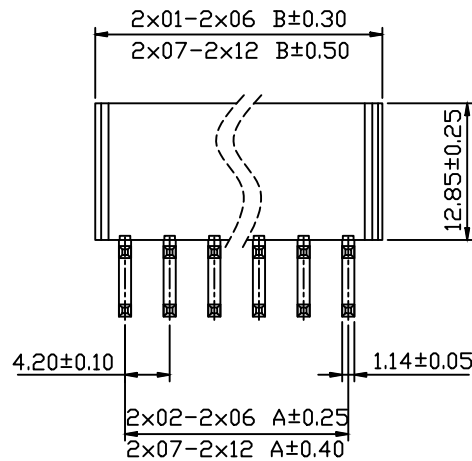

Recommended P.C.B Layout

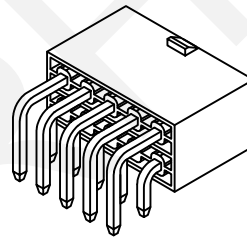

RHTECP NINGBO RHT ELECTRONIC CO.,LTD

UNITS:mm	SHEET SIZE: A4	SCALE:---	DRWN BY PAN
0~3	3~18	18~50	50~120
±0.12	±0.15	±0.3	±0.5
CHK'D BY FENG		APPR BY ZHAN	

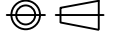
4.20mm Pitch Mini-Fit JR 5556 5557
 5559 5566 5569 Wire To Board Connector
 THIRD ANGLE PROJECTION

 RHTAY4.20-2x02-R

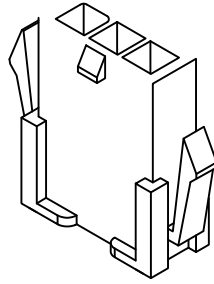
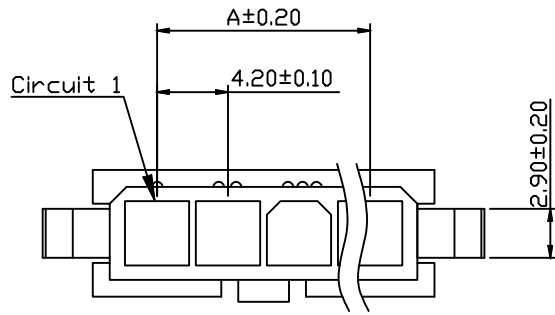
RoHS Compliance



Pin	Dimension(mm)	
	A	B
02	4.20	9.80
03	8.40	14.00
04	12.60	18.20
05	16.80	22.40
06	21.00	26.60

Material:

Housing: PA66,UL94V-0/2

Electrical Characteristics:

Rated Current : 7.0A AC DC

Voltage Rating : 600V AC,DC

Temperature Range: -25°C~+85°C

Insulator Resistance: 1000MΩ/Min.

Withstanding Voltage: 1500V AC/Minute

Contact Resistance: 20MΩ/Max

Order Information:

RHTAY4.20-1x02-FH

Pitch:4.20mm

Pins: _____

1-Single Layer

2-Double Layer

No.of 02~06 Pins _____

Type: _____

MH/FH -Hosing

MT/FT-Terminal

W1-Without Ear

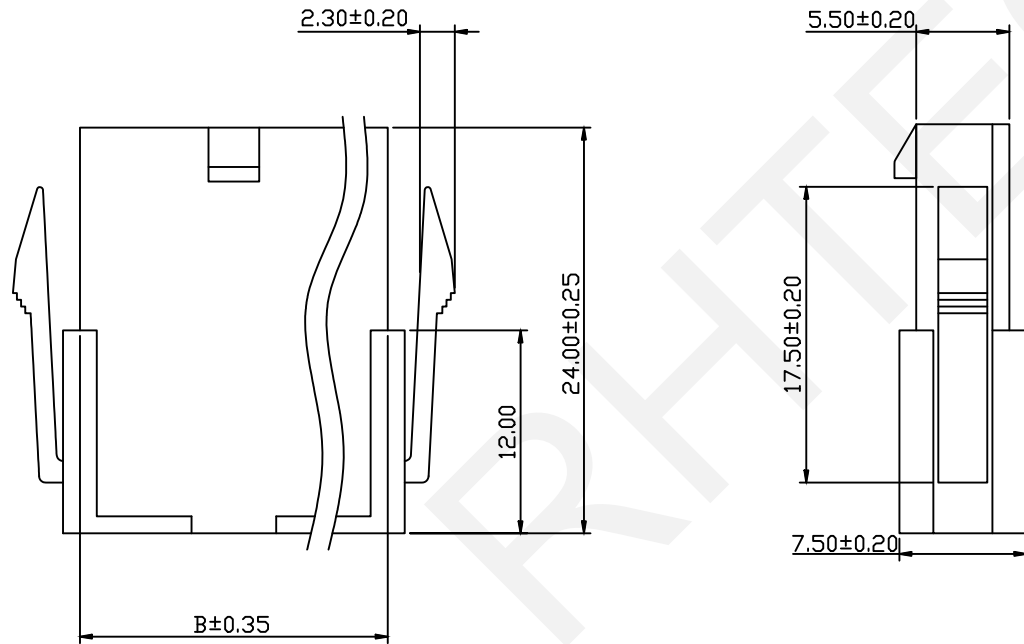

RHTECP NINGBO RHT ELECTRONIC CO.,LTD

UNITS:mm	SHEET SIZE: A4			SCALE:---	DRWN BY PAN
0~3	3~18	18~50	50~120	CHK'D BY FENG	
±0.12	±0.15	±0.3	±0.5	APPR BY ZHAN	

4.20mm Pitch Mini-Fit JR 5556 5557
5559 5566 5569 Wire To Board Connector

THIRD ANGLE PROJECTION

RHTAY4.20-1x02-FH

RoHS Compliance

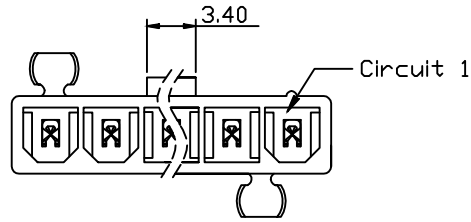

Pin	Dimension(mm)	
	A	B
02	4.20	9.60
03	8.40	13.80
04	12.60	18.00
05	16.80	22.20
06	21.00	26.40

Material:
 Housing: PA66,UL94V-0/2
 Contacts:Brass
 Finish:Tin-Plated Or Gold-Flash

Electrical Characteristics:
 Rated Current : 7.0A AC DC
 Voltage Rating : 600V AC,DC
 Temperature Range: -25°C~+85°C
 Insulator Resistance: 1000MΩ/Min.
 Withstanding Voltage: 1500V AC/Minute
 Contact Resistance: 20MΩ/Max

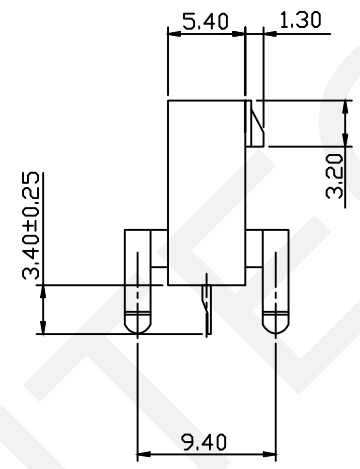
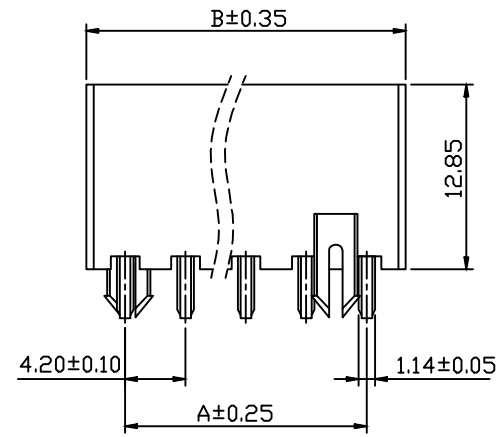

Order Information:
RHTAY4.20-1x02-SW

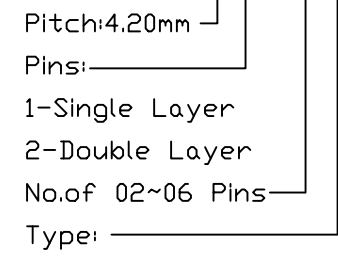

Type: _____
 S/SW/SB-Straight Male Pin
 R/RW/RB-Right Angle Male Pin

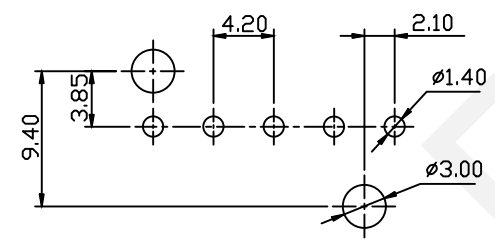

Recommended P.C.B Layout

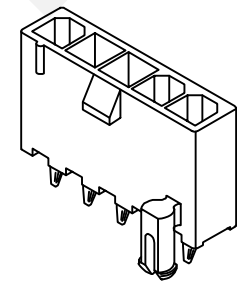

RHTECP NINGBO RHT ELECTRONIC CO.,LTD

UNITS:mm	SHEET SIZE: A4	SCALE:---	DRWN BY PAN
0~3	3~18	18~50	50~120
±0.12	±0.15	±0.3	±0.5

CHK'D BY FENG
 APPR BY ZHAN

4.20mm Pitch Mini-Fit JR 5556 5557
 5559 5566 5569 Wire To Board Connector
 THIRD ANGLE PROJECTION
 RHTAY4.20-1x02-SW

RoHS Compliance

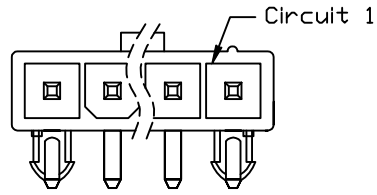

03~06P

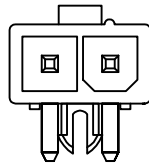

2P

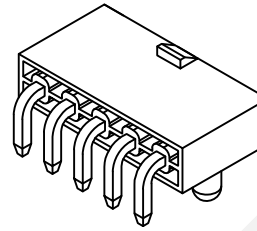

Material:
 Housing: PA66,UL94V-0/2
 Contacts:Brass
 Finish:Tin-Plated Or Gold-Flash

Electrical Characteristics:
 Rated Current : 7.0A AC DC
 Voltage Rating : 600V AC,DC
 Temperature Range: -25°C~+85°C
 Insulator Resistance: 1000MΩ/Min.
 Withstanding Voltage: 1500V AC/Minute
 Contact Resistance: 20MΩ/Max

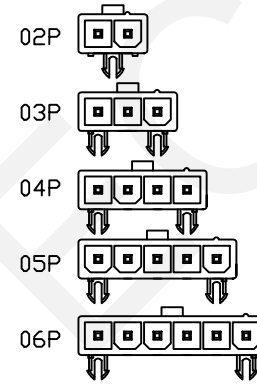
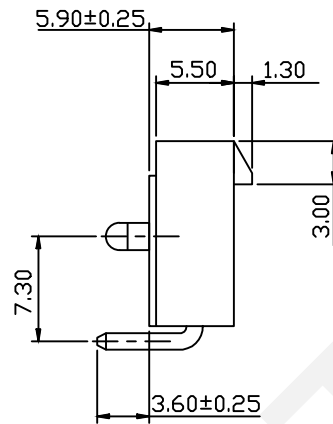
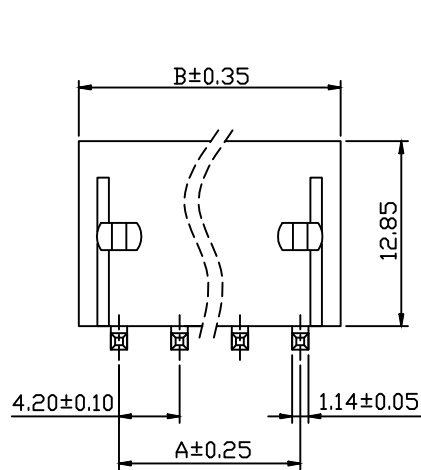

Circuit Size Layout

Order Information:
RHTAY4.20-1x02-RW

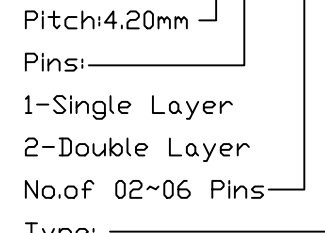

Pitch:4.20mm
 Pins:
 1-Single Layer
 2-Double Layer
 No.of 02~06 Pins
 Type:

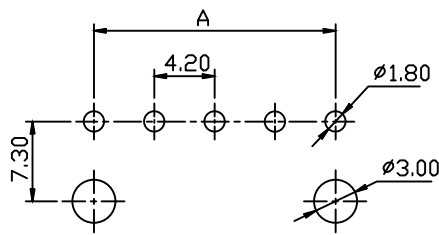

03~06P
 P.C.B Layout

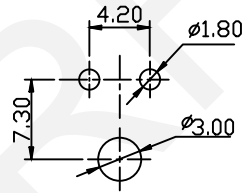

02P
 P.C.B Layout

Pin	Dimension(mm)	
	A	B
02	4.20	9.80
03	8.40	14.00
04	12.60	18.20
05	16.80	22.40
06	21.00	26.60

RHTECP NINGBO RHT ELECTRONIC CO.,LTD

UNITS:mm SHEET SIZE: A4 SCALE:--- DRWN BY PAN
 0~3 3~18 18~50 50~120 CHK'D BY FENG
 ±0.12 ±0.15 ±0.3 ±0.5 APPR BY ZHAN

4.20mm Pitch Mini-Fit JR 5556 5557
 5559 5566 5569 Wire To Board Connector
 THIRD ANGLE PROJECTION
 RHTAY4.20-1x02-RW

RoHS Compliance

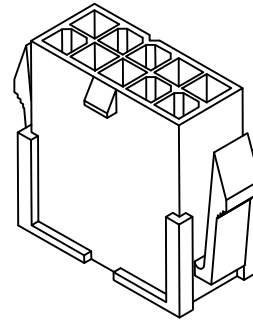
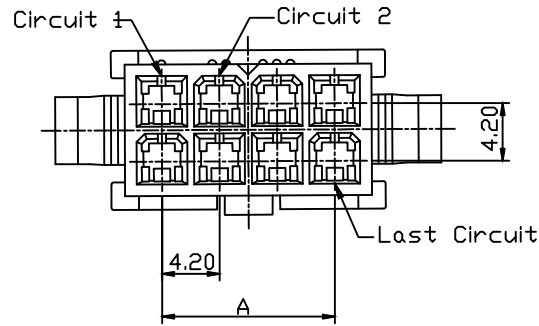

Material:
Housing: PA66,UL94V-0/2

Electrical Characteristics:
Rated Current : 7.0A AC DC
Voltage Rating : 600V AC,DC
Temperature Range: -25°C~+85°C
Insulator Resistance: 1000MΩ/Min.
Withstanding Voltage: 1500V AC/Minute
Contact Resistance: 20MΩ/Max

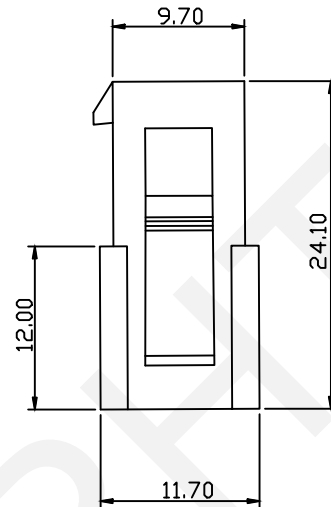
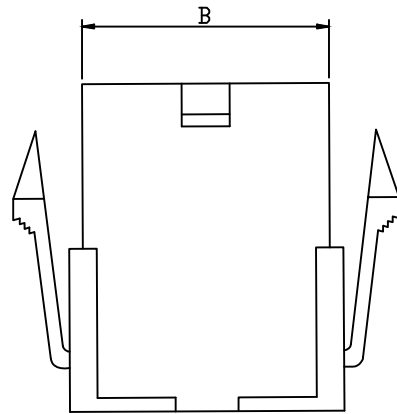

Pin	Dimension(mm)	
	A	B
2x01	---	5.60
2x02	4.20	9.80
2x03	8.40	14.00
2x04	12.60	18.20
2x05	16.80	22.40
2x06	21.00	26.60
2x07	25.20	30.80
2x08	29.40	35.00
2x09	33.60	39.20
2x10	37.80	43.40
2x11	42.00	47.60
2x12	46.20	51.80

Order Information:

RHTAY4.20-2x02-FH

Pitch:4.20mm

Pins: _____

1-Single Layer

2-Double Layer

No.of 01~12 Pins _____

Type: _____

MH/FH -Hosing

MT/FT-Terminal

W1-Without Ear

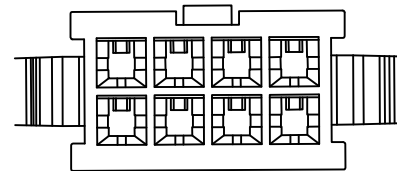

NINGBO RHT ELECTRONIC CO.,LTD

UNITS:mm	SHEET SIZE: A4	SCALE:---	DRWN BY PAN
0~3	3~18	18~50	50~120
±0.12	±0.15	±0.3	±0.5

CHK'D BY FENG
APPR BY ZHAN

4.20mm Pitch Mini-Fit JR 5556 5557 5559 5566 5569 Wire To Board Connector	
THIRD ANGLE PROJECTION 	RHTAY4.20-2x02-FH

RoHS Compliance

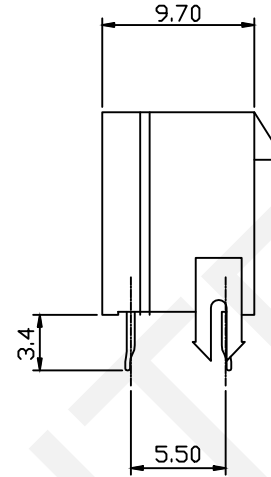
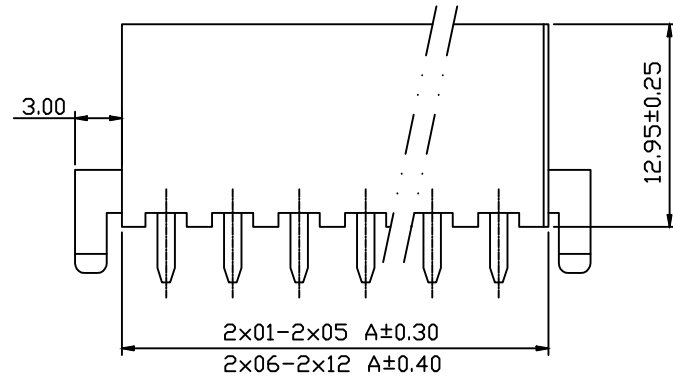
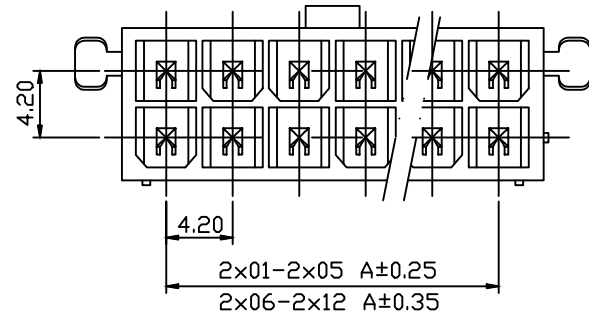

Pin	Dimension(mm)	
	A	B
2x01	---	5.60
2x02	4.20	9.80
2x03	8.40	14.00
2x04	12.60	18.20
2x05	16.80	22.40
2x06	21.00	26.60
2x07	25.20	30.80
2x08	29.40	35.00
2x09	33.60	39.20
2x10	37.80	43.40
2x11	42.00	47.60
2x12	46.20	51.80

Material:
 Housing: PA66,UL94V-2
 Contacts:Brass
 Finish:Tin-Plated Or Nickel

Electrical Characteristics:
 Rated Current : 9.0A AC DC
 Voltage Rating : 600V AC,DC
 Temperature Range: -25°C~+85°C
 Insulator Resistance: 1000MΩ/Min.
 Withstanding Voltage: 1500V AC/Minute
 Contact Resistance: 10MΩ/Max

Order Information:
RHTAY4.20-2x02-SW

Pitch:4.20mm
 Pins: _____
 1-Single Layer
 2-Double Layer
 No.of 01~12 Pins _____
 Type: _____
 S/SW/SB-Straight Male Pin
 R/RW/RB-Right Angle Male Pin

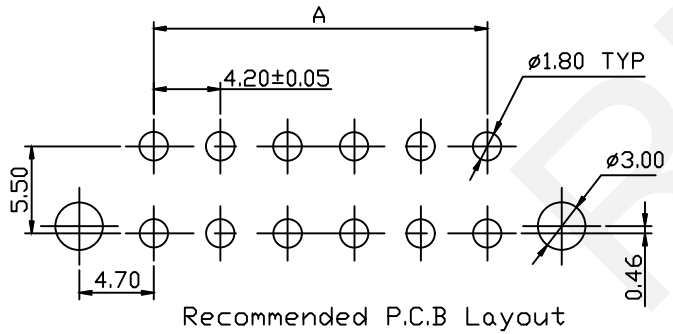

Recommended P.C.B Layout

UNITS:mm	SHEET SIZE: A4	SCALE:---	DRWN BY PAN
0~3	3~18	18~50	50~120
±0.12	±0.15	±0.3	±0.5
CHK'D BY FENG		APPR BY ZHAN	

4.20mm Pitch Mini-Fit JR 5556 5557
 5559 5566 5569 Wire To Board Connector

THIRD ANGLE PROJECTION

RHTAY4.20-2x02-SW

RoHS Compliance

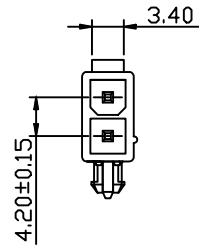

2x01P

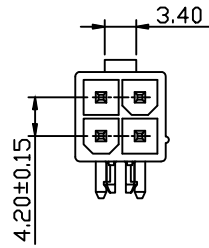

2x02P

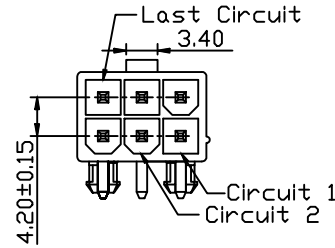

2x03~2x12P

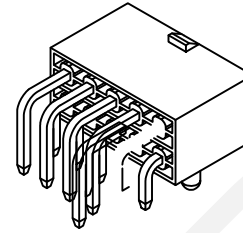

Material:
Housing: PA66,UL94V-2
Contacts:Brass
Finish: Tin-Plated Or Nickel

Electrical Characteristics:
Rated Current : 7.0A AC DC
Voltage Rating : 600V AC,DC
Temperature Range: -25°C~+85°C
Insulator Resistance: 1000MΩ/Min.
Withstanding Voltage: 1500V AC/Minute
Contact Resistance: 20MΩ/Max

Order Information:
RHTAY4.20-2x02-RW

Pitch:4.20mm

Pins:

1-Single Layer

2-Double Layer

No.of 01~12 Pins

Type:

S/SW/SB-Straight Male Pin

R/RW/RB-Right Angle Male Pin

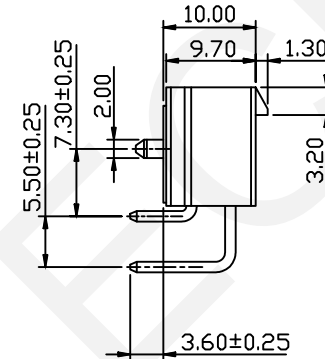
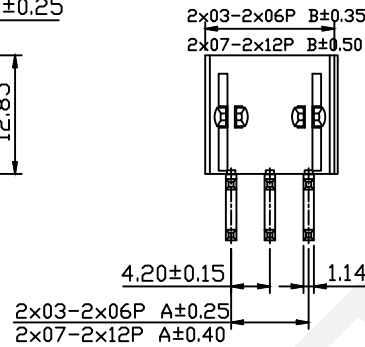
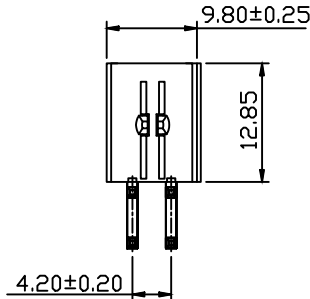
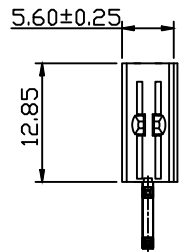

Pin	Dimension(mm)	
	A	B
2x01	---	5.60
2x02	4.20	9.80
2x03	8.40	14.00
2x04	12.60	18.20
2x05	16.80	22.40
2x06	21.00	26.60
2x07	25.20	30.80
2x08	29.40	35.00
2x09	33.60	39.20
2x10	37.80	43.40
2x11	42.00	47.60
2x12	46.20	51.80

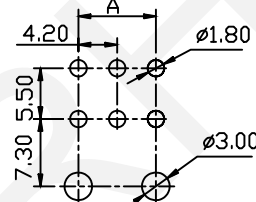
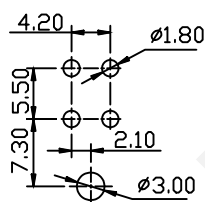
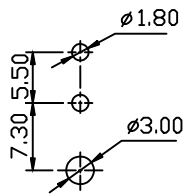

PCB Layout:Component Side
Recommended PCB Thickness 1.78MAX

RHTECP NINGBO RHT ELECTRONIC CO.,LTD

UNITS:mm	SHEET SIZE: A4	SCALE:---	DRWN BY PAN
0~3	3~18	18~50	50~120
±0.12	±0.15	±0.3	±0.5
CHK'D BY FENG		APPR BY ZHAN	

4.20mm Pitch Mini-Fit JR 5556 5557
5559 5566 5569 Wire To Board Connector
THIRD ANGLE PROJECTION
 RHTAY4.20-2x02-RW

RoHS Compliance

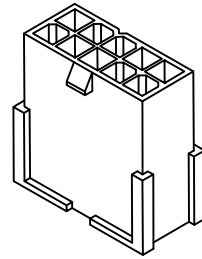
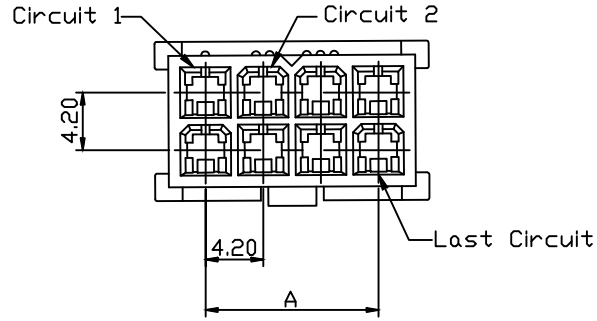

Material:
Housing: PA66,UL94V-0/2

Electrical Characteristics:
Rated Current : 7.0A AC DC
Voltage Rating : 600V AC,DC
Temperature Range: -25°C~+85°C
Insulator Resistance: 1000MΩ/Min.
Withstanding Voltage: 1500V AC/Minute
Contact Resistance: 20MΩ/Max

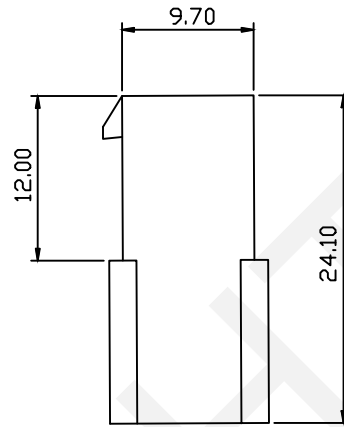
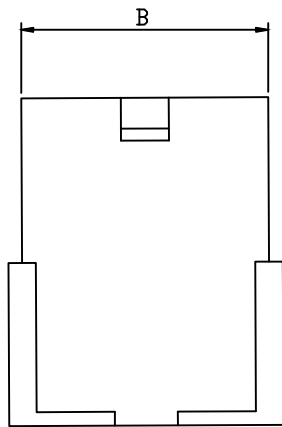

Pin	Dimension(mm)	
	A	B
2x01	---	5.60
2x02	4.20	9.80
2x03	8.40	14.00
2x04	12.60	18.20
2x05	16.80	22.40
2x06	21.00	26.60
2x07	25.20	30.80
2x08	29.40	35.00
2x09	33.60	39.20
2x10	37.80	43.40
2x11	42.00	47.60
2x12	46.20	51.80

Order Information:
RHTAY4.20-2x02-W1

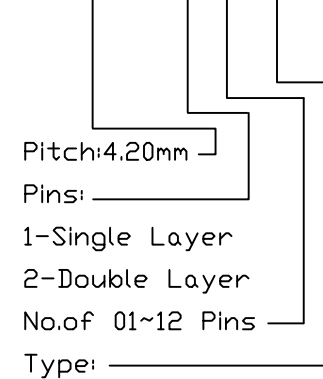

Pitch:4.20mm
Pins: _____
1-Single Layer
2-Double Layer
No.of 01~12 Pins _____
Type: _____
MH/FH -Hosing
MT/FT-Terminal
W1-Without Ear

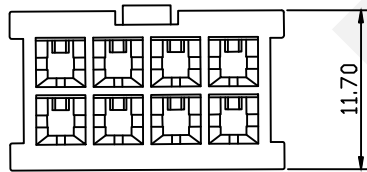

RHTECP NINGBO RHT ELECTRONIC CO.,LTD

UNITS:mm	SHEET SIZE: A4			SCALE:---	DRWN BY PAN
0~3	3~18	18~50	50~120	CHK'D BY FENG	
±0.12	±0.15	±0.3	±0.5	APPR BY ZHAN	

4.20mm Pitch Mini-Fit JR 5556 5557
5559 5566 5569 Wire To Board Connector
THIRD ANGLE PROJECTION
 RHTAY4.20-2x02-W1

RoHS Compliance

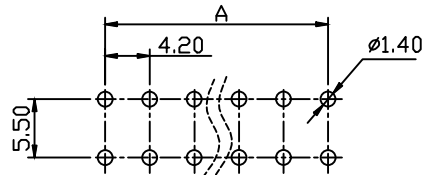
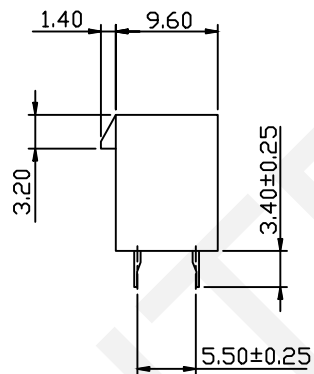
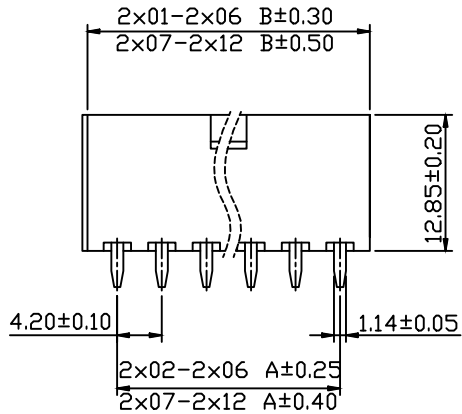
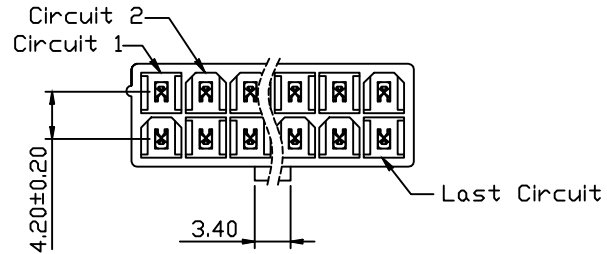

Recommended P.C.B Layout

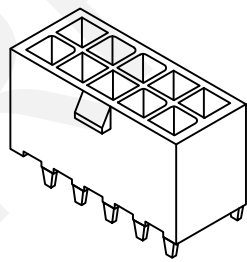

Pin	Dimension(mm)	
	A	B
2x01	---	5.60
2x02	4.20	9.80
2x03	8.40	14.00
2x04	12.60	18.20
2x05	16.80	22.40
2x06	21.00	26.60
2x07	25.20	30.80
2x08	29.40	35.00
2x09	33.60	39.20
2x10	37.80	43.40
2x11	42.00	47.60
2x12	46.20	51.80

Material:
 Housing: PA66,UL94V-0/2
 Contacts:Brass
 Finish:Tin-Plated Or Gold-Flash

Electrical Characteristics:
 Rated Current : 7.0A AC DC
 Voltage Rating : 600V AC,DC
 Temperature Range: -25°C~+85°C
 Insulator Resistance: 1000MΩ/Min.
 Withstanding Voltage: 1500V AC/Minute
 Contact Resistance: 20MΩ/Max

Order Information:

RHTAY4.20-2x02-SB

Pitch:4.20mm

Pins:

1-Single Layer

2-Double Layer

No.of 01~12 Pins

Type:

S/SW/SB-Straight Male Pin

R/RW/RB-Right Angle Male Pin



NINGBO RHT ELECTRONIC CO.,LTD

UNITS:mm	SHEET SIZE: A4	SCALE:---	DRWN BY PAN
0~3	3~18	18~50	50~120
±0.12	±0.15	±0.3	±0.5

CHK'D BY FENG
 APPR BY ZHAN

4.20mm Pitch Mini-Fit JR 5556 5557
 5559 5566 5569 Wire To Board Connector
 THIRD ANGLE PROJECTION
 RHTAY4.20-2x02-SB

RoHS Compliance

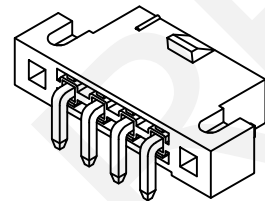
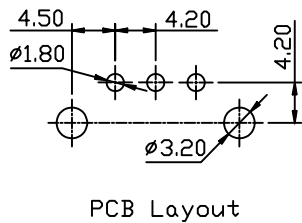
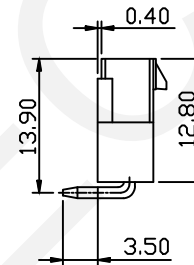
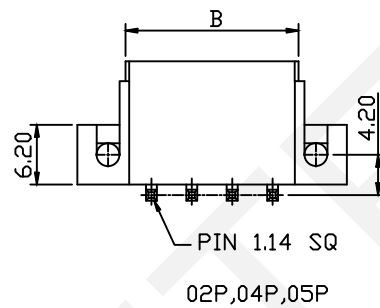
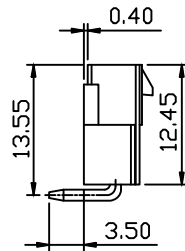
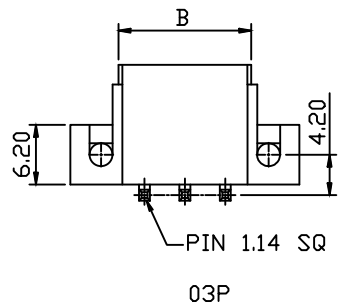
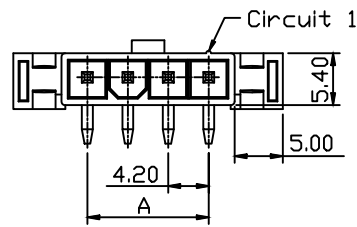
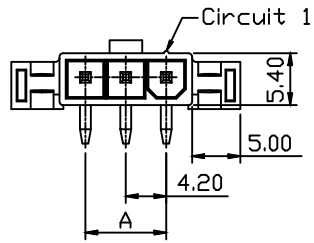

Pin	Dimension(mm)	
	A	B
02	4.20	9.60
03	8.40	13.80
04	12.60	18.00
05	16.80	22.20
06	21.00	26.40

Material:

Housing: PA66,UL94V-0/2

Contacts:Brass

Finish: Tin-Plated Or Gold-Flash

Electrical Characteristics:

Rated Current : 7.0A AC DC

Voltage Rating : 600V AC,DC

Temperature Range: -25°C~+85°C

Insulator Resistance: 1000MΩ/Min.

Withstanding Voltage: 1500V AC/Minute

Contact Resistance: 20MΩ/Max

Order Information:

RHTAY4.20-1x02-RB

Pitch:4.20mm

Pins:

1-Single Layer

2-Double Layer

No.of 02~06 Pins

Type:

S/SW/SB-Straight Male Pin

R/RW/RB-Right Angle Male Pin

RHTECP NINGBO RHT ELECTRONIC CO.,LTD

UNITS:mm	SHEET SIZE: A4	SCALE:---	DRWN BY PAN
0~3	3~18	18~50	50~120
±0.12	±0.15	±0.3	±0.5

CHK'D BY FENG
APPR BY ZHAN

4.20mm Pitch Mini-Fit JR 5556 5557
5559 5566 5569 Wire To Board Connector
THIRD ANGLE PROJECTION
 RHTAY4.20-1x02-RB

RoHS Compliance

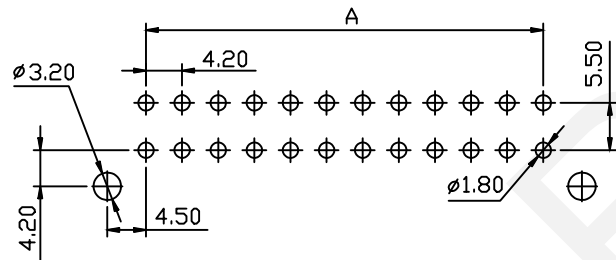
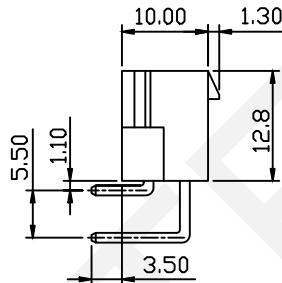
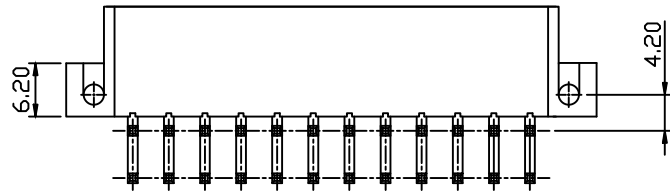
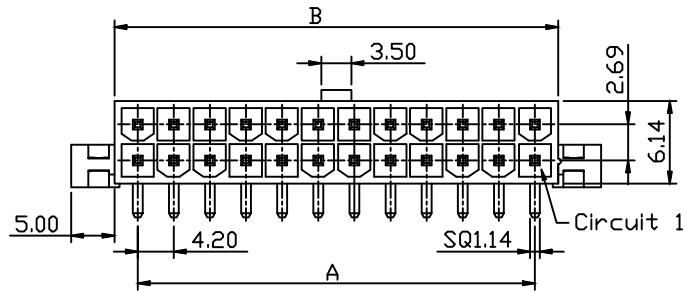

PCB Layout

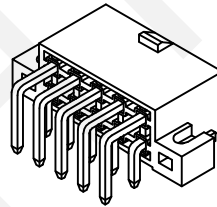

Pin	Dimension(mm)	
	A	B
2x01	---	5.60
2x02	4.20	9.60
2x03	8.40	13.80
2x04	12.60	18.00
2x05	16.80	22.20
2x06	21.00	26.40
2x07	25.20	30.60
2x08	29.40	34.80
2x09	33.60	39.00
2x10	37.80	43.20
2x11	42.00	47.40
2x12	46.20	51.60

Material:

Housing: PA66,UL94V-0/2

Contacts:Brass

Finish:Tin-Plated Or Gold-Flash

Electrical Characteristics:

Rated Current : 7.0A AC DC

Voltage Rating : 600V AC,DC

Temperature Range: -25°C~+85°C

Insulator Resistance: 1000MΩ/Min.

Withstanding Voltage: 1500V AC/Minute

Contact Resistance: 20MΩ/Max

Order Information:

RHTAY4.20-2x02-RB

Pitch:4.20mm

Pins:

1-Single Layer

2-Double Layer

No.of 01~12 Pins

Type:

S/SW/SB-Straight Male Pin

R/RW/RB-Right Angle Male Pin

RHTECP NINGBO RHT ELECTRONIC CO.,LTD

UNITS:mm	SHEET SIZE: A4	SCALE:---	DRWN BY PAN
0~3	3~18	18~50	50~120
±0.12	±0.15	±0.3	±0.5
CHK'D BY FENG		APPR BY ZHAN	

4.20mm Pitch Mini-Fit JR 5556 5557
5559 5566 5569 Wire To Board Connector

THIRD ANGLE PROJECTION



RHTAY4.20-2x02-RB