

RoHS Compliance

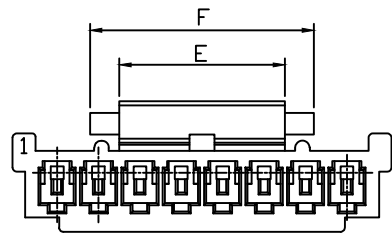

04-20P

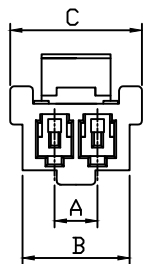

02P

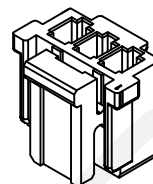

03P

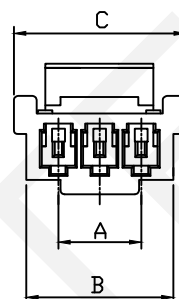
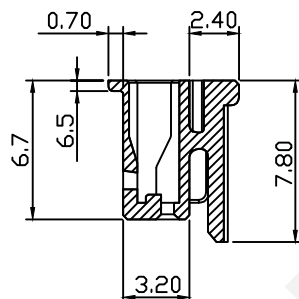
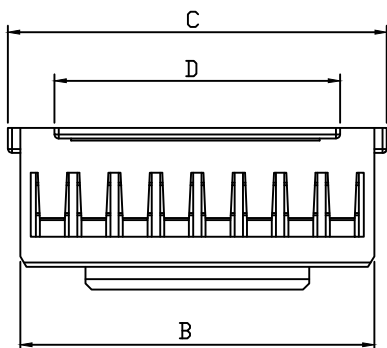

04-20P

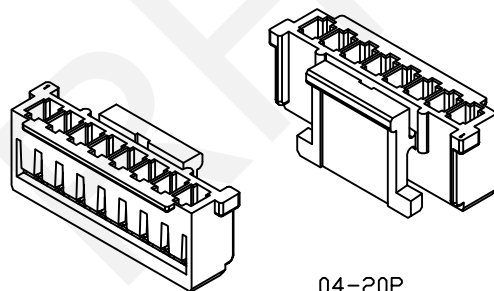
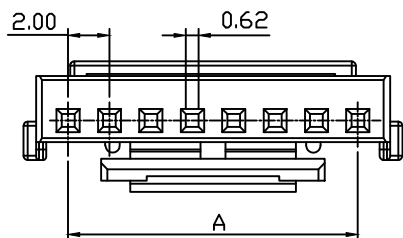

Pin	Dimension(mm)					
	A	B	C	D	E	F
02	2.00	5.10	7.17	---	---	---
03	4.00	7.10	9.17	---	---	---
04	6.00	9.10	10.30	4.50	7.80	7.80
05	8.00	11.10	12.30	4.50	7.80	7.80
06	10.00	13.10	14.30	4.50	7.80	7.80
07	12.00	15.10	16.30	4.50	7.80	7.80
08	14.00	17.10	18.30	4.50	7.80	7.80
09	16.00	19.10	20.30	4.50	7.80	7.80
10	18.00	21.10	22.30	11.00	14.30	14.30
11	20.00	23.10	24.30	11.00	14.30	14.30
12	22.00	25.10	26.30	11.00	14.30	14.30
13	24.00	27.10	28.30	11.00	14.30	14.30
14	26.00	29.10	30.30	11.00	14.30	14.30
15	28.00	31.10	32.30	11.00	14.30	14.30
16	30.00	33.10	34.30	11.00	14.30	14.30
17	32.00	35.10	36.30	11.00	14.30	14.30
18	34.00	37.10	38.30	11.00	14.30	14.30
19	36.00	39.10	40.30	11.00	14.30	14.30
20	38.00	41.10	42.30	11.00	14.30	14.30

Material:Housing: PA66,UL94V-0

Order Information:

RHTAYA3-2.00-XX-H

Electrical Characteristics:

Current Rating : 2.0AMP

Voltage Rating : 125V AC,DC

Temperature Range: -40°C~+105°C

Insulator Resistance: 1000MΩ/Min.

Withstanding Voltage: 800V AC/DC

Contact Resistance: 20MΩ/Max

Pitch:2.00mm

XX-No.of 02~20Pin

Type:

T-Terminal H-Hosing

S-Straight Male Pin

R-Right Angle Male Pin

NINGBO RHT ELECTRONIC CO.,LTD

UNITS:mm	SHEET SIZE: A4				SCALE:---	DRWN BY PAN
0~3	3~18	18~50	50~120	CHK'D BY FENG	2.00mm Pitch 35507 35362 35362 Wire To Board Connector	
±0.12	±0.15	±0.3	±0.5	APPR BY ZHAN	THIRD ANGLE PROJECTION	RHTAYA3-2.00-XX-H

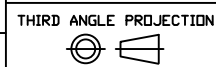

RHTAYA3-2.00-XX-H

RoHS Compliance

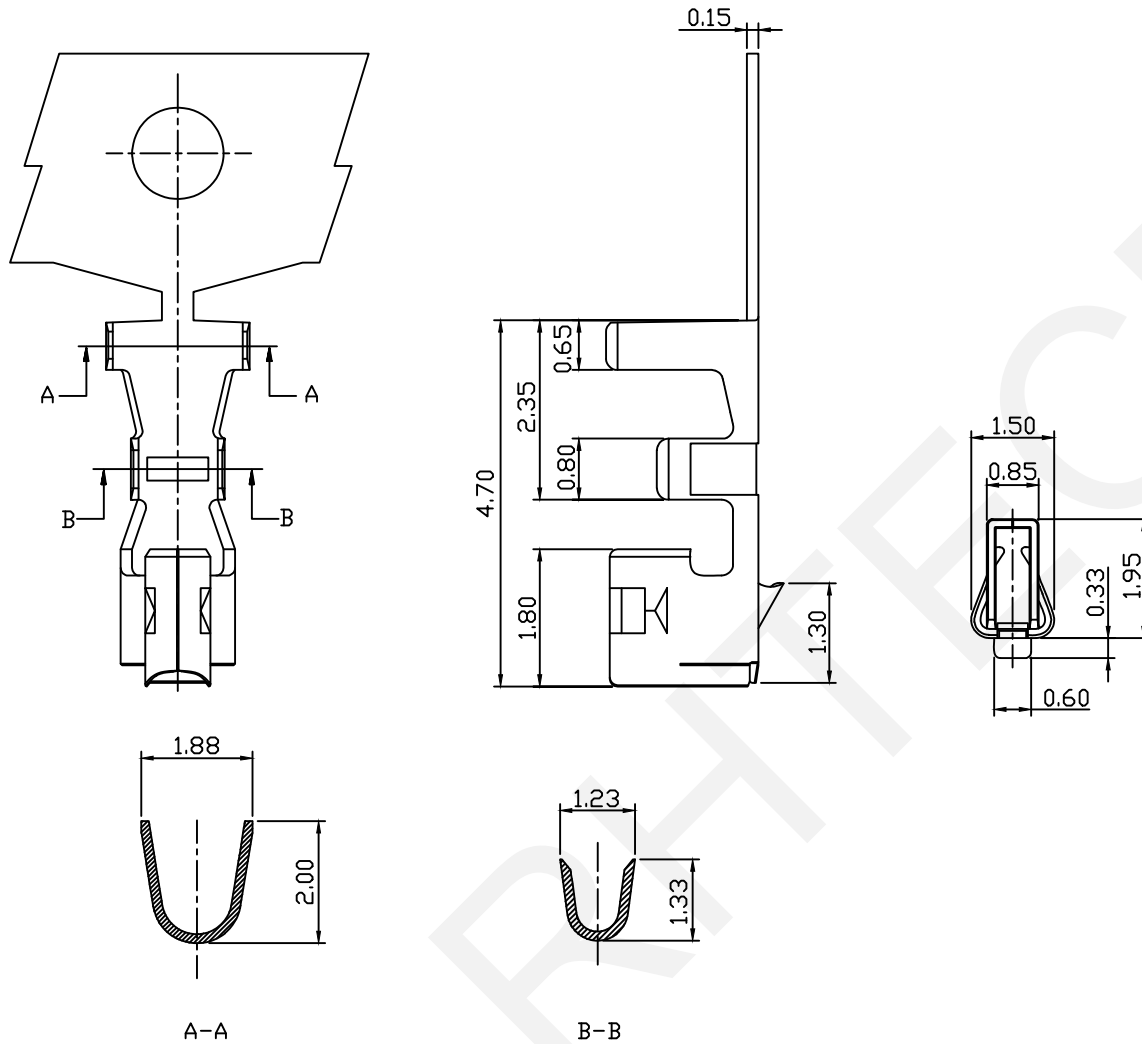

Material:  
 Terminal: Phosphor Bronze  
 Plating: Tin plated  
 Applicable Wires: AWG #24~#30  
 Insulation  $\phi$ : 1.50mm  
 Qty/Reel: 10000 PCS

Electrical Characteristics:  
 Current Rating : 2.0AMP  
 Voltage Rating : 125V AC,DC  
 Temperature Range:  $-40^{\circ}\text{C} \sim +105^{\circ}\text{C}$   
 Insulator Resistance:  $1000\Omega/\text{Min.}$   
 Withstanding Voltage: 800V AC/DC  
 Contact Resistance:  $20\text{M}\Omega/\text{Max}$

Order Information:

RHTAYA3-2.00-T

Pitch: 2.00mm

Type:

T-Terminal H-Hosing  
 S-Straight Male Pin  
 R-Right Angle Male Pin

NINGBO RHT ELECTRONIC CO.,LTD

UNITS:mm	SHEET SIZE: A4				SCALE:----	DRWN BY PAN
0~3	3~18	18~50	50~120	CHK'D BY FENG	2.00mm Pitch 35507 35362 35363 Wire To Board Connector	
$\pm 0.12$	$\pm 0.15$	$\pm 0.3$	$\pm 0.5$	APPR BY ZHAN	THIRD ANGLE PROJECTION	RHTAYA3-2.00-T

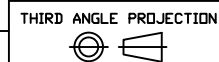

RHTAYA3-2.00-T

RoHS Compliance

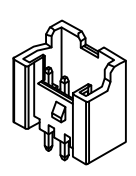
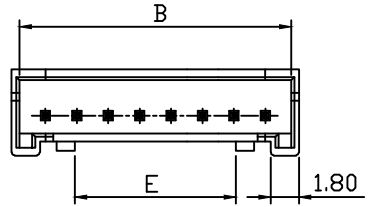

02P

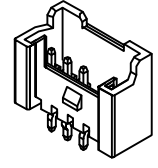

03P

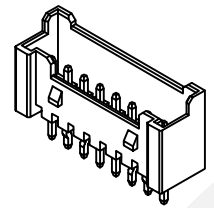

04P-20P

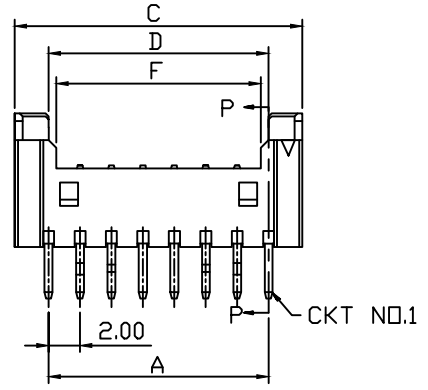

04P-20P

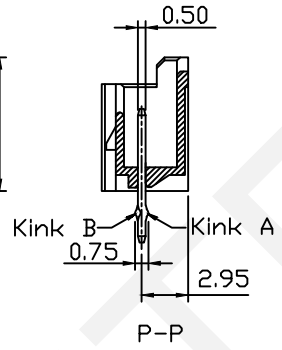
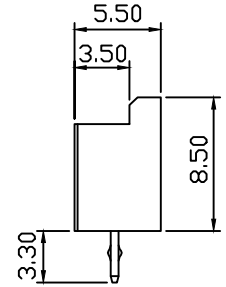

P-P

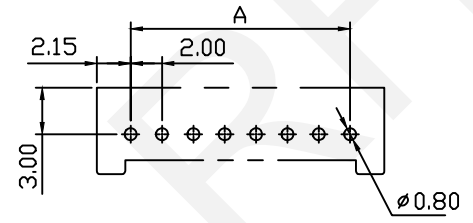
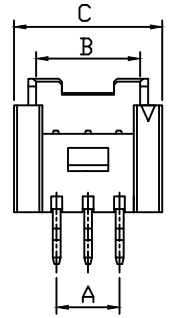
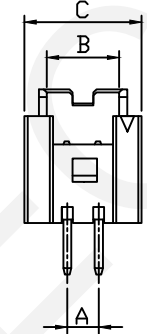

Recommended PCB Layout

Pin	Dimension(mm)					
	A	B	C	D	E	F
02	2.00	5.30	7.70	---	---	---
03	4.00	7.30	9.70	---	---	---
04	6.00	9.30	10.30	6.00	4.25	6.70
05	8.00	11.30	12.30	8.00	4.25	7.00
06	10.00	13.30	14.30	10.00	4.25	7.00
07	12.00	15.30	16.30	12.00	4.25	7.00
08	14.00	17.30	18.30	14.00	8.25	11.00
09	16.00	19.30	20.30	16.00	8.25	11.00
10	18.00	21.30	22.30	18.00	8.25	11.00
11	20.00	23.30	24.30	20.00	8.25	11.00
12	22.00	25.30	26.30	22.00	8.25	11.00
13	24.00	27.30	28.30	24.00	8.25	11.00
14	26.00	29.30	30.30	26.00	8.25	11.00
15	28.00	31.30	32.30	28.00	8.25	11.00
16	30.00	33.30	34.30	30.00	8.25	11.00
17	32.00	35.30	36.30	32.00	8.25	11.00
18	34.00	37.30	38.30	34.00	8.25	11.00
19	36.00	39.30	40.30	36.00	8.25	11.00
20	38.00	41.30	42.30	38.00	8.25	11.00

Material:  
 Housing: PA66,UL94V-0  
 Contact:Brass  
 Plating: Tin plated  
 Electrical Characteristics:  
 Current Rating : 2.0AMP  
 Voltage Rating : 125V AC,DC  
 Temperature Range: -40°C~+105°C  
 Insulator Resistance: 1000MΩ/Min.  
 Withstanding Voltage: 800V AC/DC  
 Contact Resistance: 20MΩ/Max

Order Information:  
 RHTAYA3-2.00-XX-H  
 Pitch:2.00mm  
 XX-No.of 02~20Pin  
 Type: \_\_\_\_\_  
 T-Terminal H-Hosing  
 S-Straight Male Pin  
 R-Right Angle Male Pin

NINGBO RHT ELECTRONIC CO.,LTD

UNITS:mm	SHEET SIZE: A4		SCALE:---	DRWN BY PAN
0~3	3~18	18~50	50~120	CHK'D BY FENG
±0.12	±0.15	±0.3	±0.5	APPR BY ZHAN

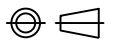
2.00mm Pitch 35507 35362 35363  
 Wire To Board Connector  
 THIRD ANGLE PROJECTION  
  
 RHTAYA3-2.00-XX-S

RoHS Compliance

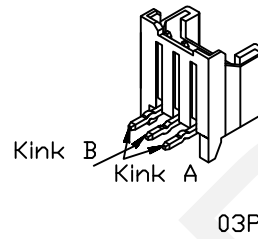
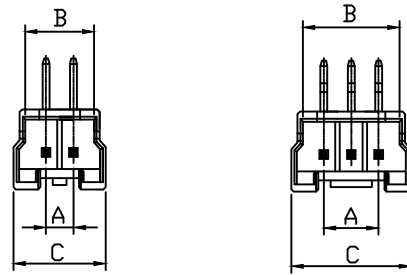
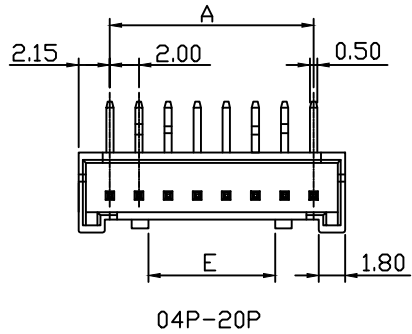

Pin	Dimension(mm)				
	A	B	C	D	E
02	2.00	5.30	6.00	2.00	---
03	4.00	7.30	8.00	3.30	---
04	6.00	9.30	10.00	4.50	---
05	8.00	11.30	12.00	4.50	7.80
06	10.00	13.30	14.00	4.50	7.80
07	12.00	15.30	16.00	4.50	7.80
08	14.00	17.30	18.00	4.50	7.80
09	16.00	19.30	20.00	4.50	7.80
10	18.00	21.30	22.00	11.00	14.30
11	20.00	23.30	24.00	11.00	14.30
12	22.00	25.30	26.00	11.00	14.30
13	24.00	27.30	28.00	11.00	14.30
14	26.00	29.30	30.00	11.00	14.30
15	28.00	31.30	32.00	11.00	14.30
16	30.00	33.30	34.00	11.00	14.30
17	32.00	35.30	36.00	11.00	14.30
18	34.00	37.30	38.00	11.00	14.30
19	36.00	39.30	40.00	11.00	14.30
20	38.00	41.30	42.00	11.00	14.30

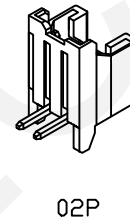
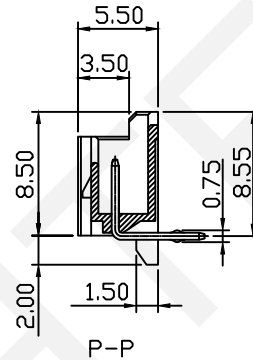
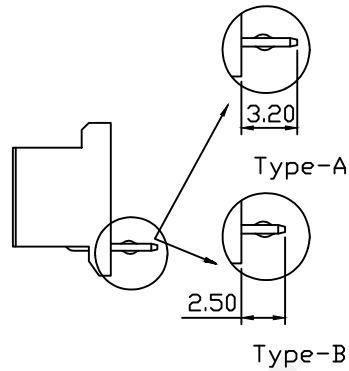
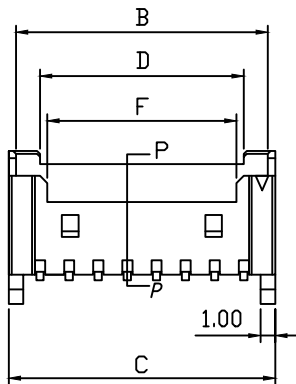

Material:  
Housing: PA66,UL94V-0  
Contact:Brass  
Plating: Tin plated  
Electrical Characteristics:  
Current Rating : 2.0AMP  
Voltage Rating : 125V AC,DC  
Temperature Range: -40°C~+105°C  
Insulator Resistance: 1000MΩ/Min.  
Withstanding Voltage: 800V AC/DC  
Contact Resistance: 20MΩ/Max

Order Information:  
RHTAYA3-2.00-XX-R  
Pitch:2.00mm  
XX-No.of 02~20Pin  
Type: \_\_\_\_\_  
T-Terminal H-Hosing  
S-Straight Male Pin  
R-Right Angle Male Pin

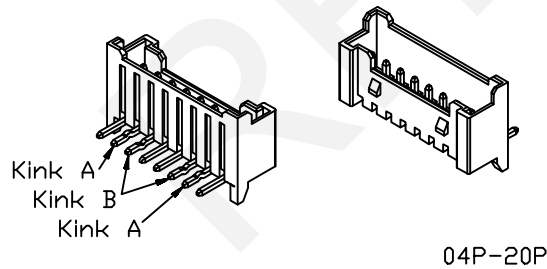
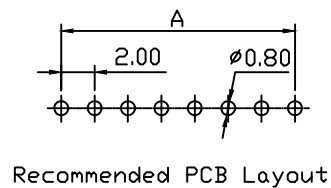

UNITS:mm	SHEET SIZE: A4	SCALE:---	DRWN BY PAN
0~3	3~18	18~50	50~120
±0.12	±0.15	±0.3	±0.5
CHK'D BY FENG		APPR BY ZHAN	

2.00mm Pitch 35507 35362 35362 Wire To Board Connector
THIRD ANGLE PROJECTION 
RHTAYA3-2.00-XX-R

NINGBO RHT ELECTRONIC CO.,LTD