

RoHS Compliance

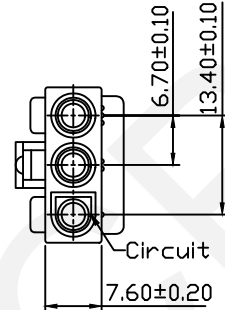

Pin	Dimensions(mm)	
	A	B
01	14.20	9.80
02	20.90	10.00
03	27.20	10.00
04	34.30	10.00

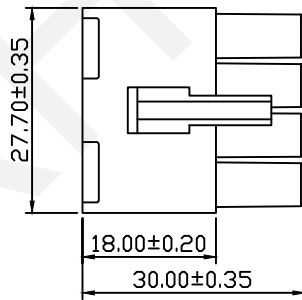
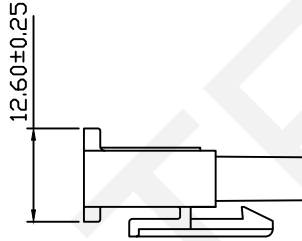
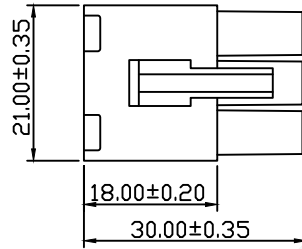
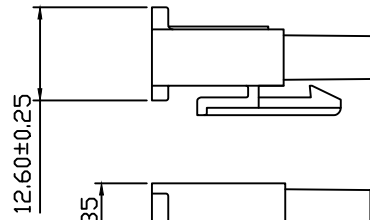
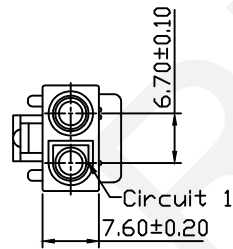
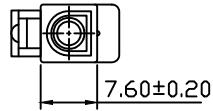
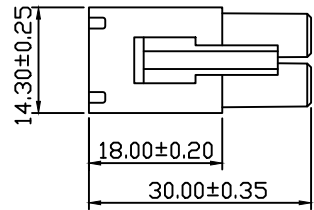
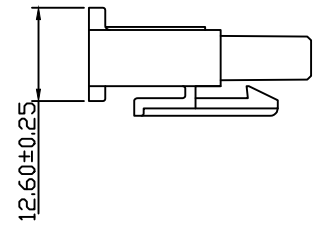
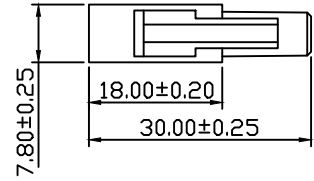
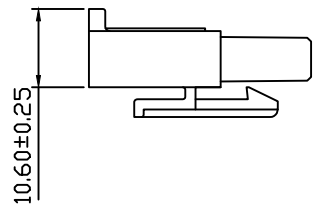
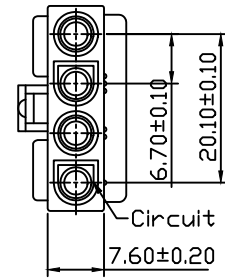

Material:
 Housing:PA66,UL94V-2,Natural
 Electrical Characteristics:
 Rated Current:12.0AMP
 Voltage Rating:600V AC,DC
 Temperature Range:-40°C~+105°C
 Insulator Resistance:1000MΩ Min
 Withstand Voltage:1500V AC/DC
 Contact Resistance:10mΩ Max

Order Information:
 RHTAY6.70-1xXX-R

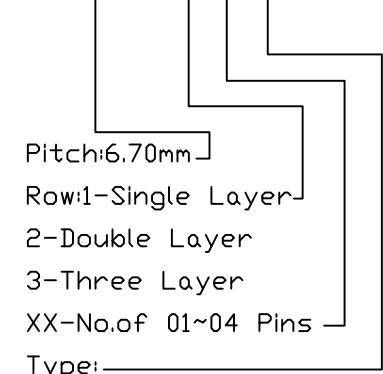

Pitch:6.70mm
 Row:1-Single Layer
 2-Double Layer
 3-Three Layer
 XX-No.of 01~04 Pins
 Type:
 R-Male Housing
 P PF-Female Housing
 FT-Female Terminal
 MT-Male Terminal
 S-Straight Male Pin

NINGBO RHT ELECTRONIC CO.,LTD

UNITS:mm	SHEET SIZE: A4	SCALE:---	DRWN BY PAN
0~3	3~18	18~50	50~120
±0.12	±0.15	±0.3	±0.5
CHK'D BY FENG		APPR BY ZHAN	

6.70mm Pitch Wire To Board Connectors
 THIRD ANGLE PROJECTION
 RHTAY6.70-1xXX-R

RoHS Compliance

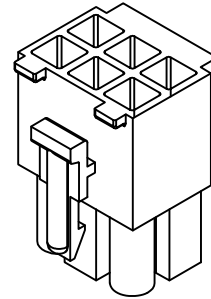
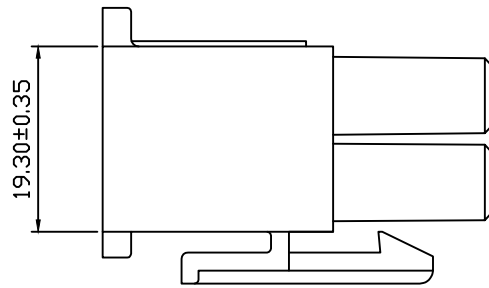

Material:

Housing: PA66, UL94V-2, UL94V-0

Color: Natural

Electrical Characteristics:

Rated Current: 12.0AMP

Voltage Rating: 600V AC, DC

Temperature Range: -40°C ~ +105°C

Insulator Resistance: 1000MΩ Min

Withstand Voltage: 1500V AC/DC

Contact Resistance: 10mΩ Max

Order Information:

RHTAY6.70-2x03-R

Pitch: 6.70mm

Row 1 - Single Layer

2 - Double Layer

3 - Three Layer

XX - No. of 03 Pins

Type: _____

R - Male Housing

P PF - Female Housing

FT - Female Terminal

MT - Male Terminal

S - Straight Male Pin

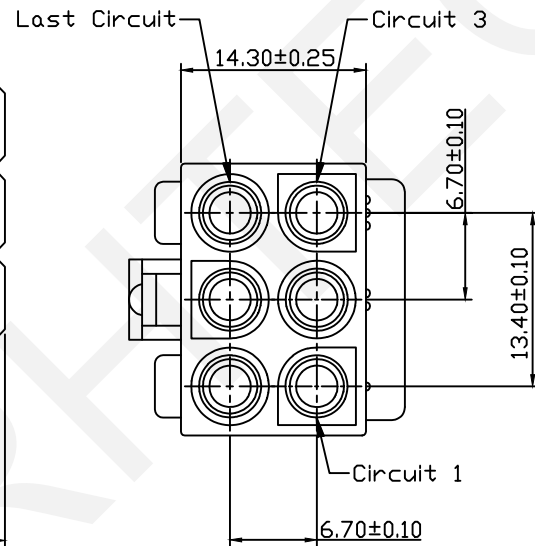
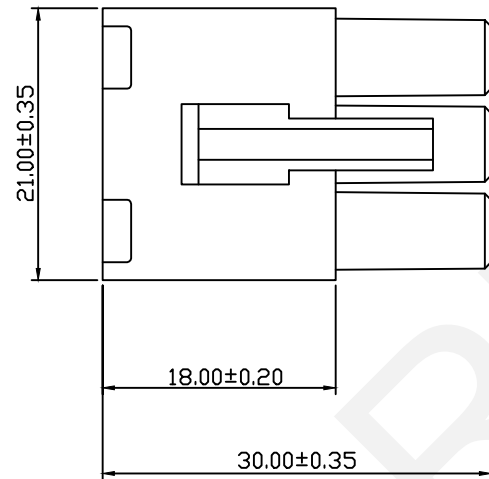

RHTECP NINGBO RHT ELECTRONIC CO.,LTD

UNITS:mm	SHEET SIZE: A4	SCALE:---	DRWN BY PAN
0~3	3~18	18~50	50~120
±0.12	±0.15	±0.3	±0.5
CHK'D BY FENG		APPR BY ZHAN	

6.70mm Pitch Wire To Board Connectors	
THIRD ANGLE PROJECTION	RHTAY6.70-2x03-R



RoHS Compliance

Material:
 Housing:PA66,UL94V-2,UL94V-0
 Color:Natural
 Electrical Characteristics:
 Rated Current:12.0AMP
 Voltage Rating:600V AC,DC
 Temperature Range:-40°C~+105°C
 Insulator Resistance:1000MΩ Min
 Withstand Voltage:1500V AC/DC
 Contact Resistance:10mΩ Max

Order Information:

RHTAY6.70-3×XX-R

Pitch:6.70mm
 Row:1-Single Layer
 2-Double Layer
 3-Three Layer
 XX-No.of 03~05 Pins
 Type:
 R-Male Housing
 P PF-Female Housing
 FT-Female Terminal
 MT-Male Terminal
 S-Straight Male Pin

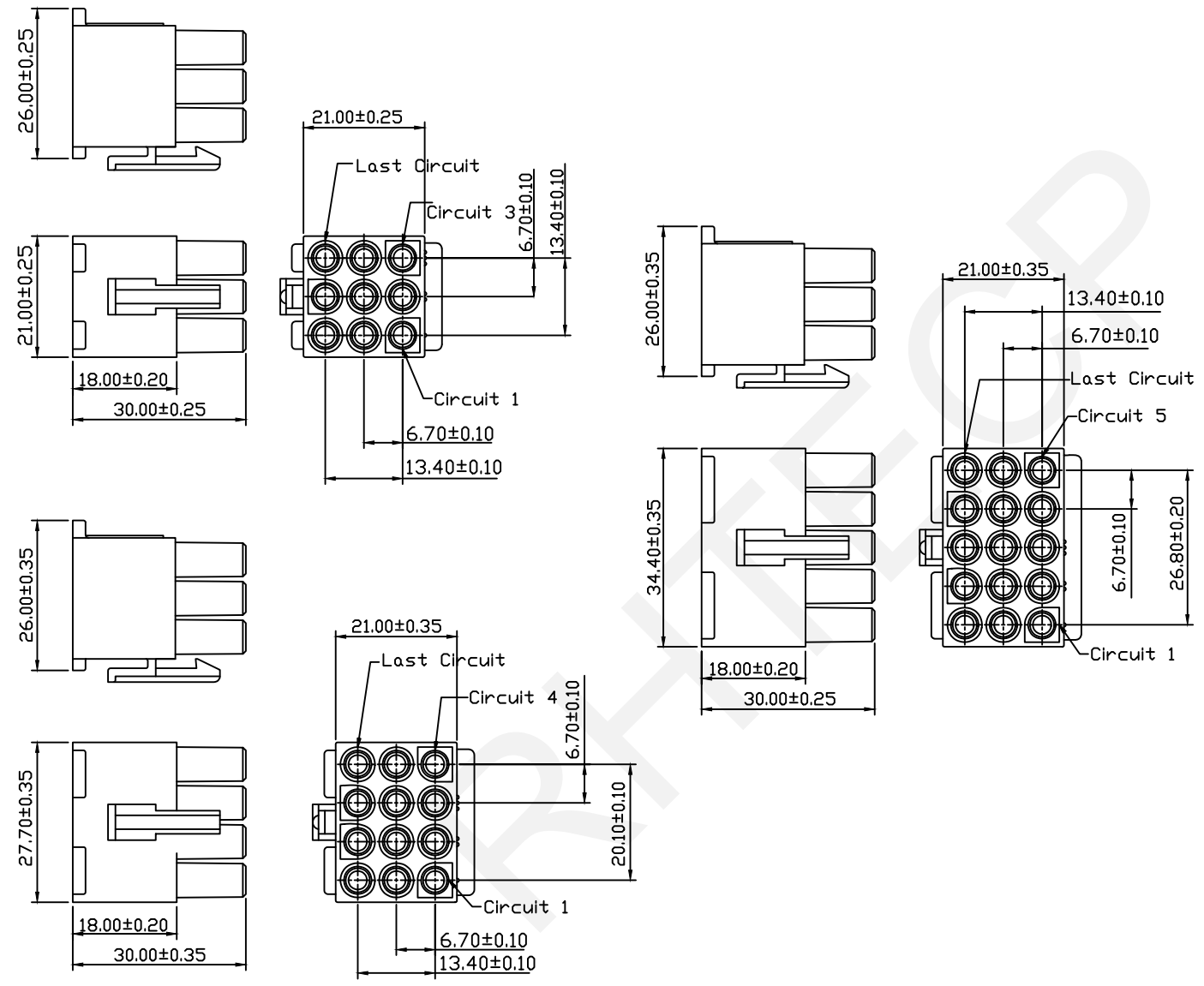

NINGBO RHT ELECTRONIC CO.,LTD

UNITS:mm	SHEET SIZE: A4	SCALE:---	DRWN BY PAN
0~3	3~18	18~50	50~120
±0.12	±0.15	±0.3	±0.5

CHK'D BY FENG
 APPR BY ZHAN

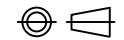
6.70mm Pitch Wire To Board Connectors
 THIRD ANGLE PROJECTION

 RHTAY6.70-3×XX-R

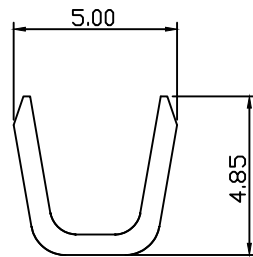
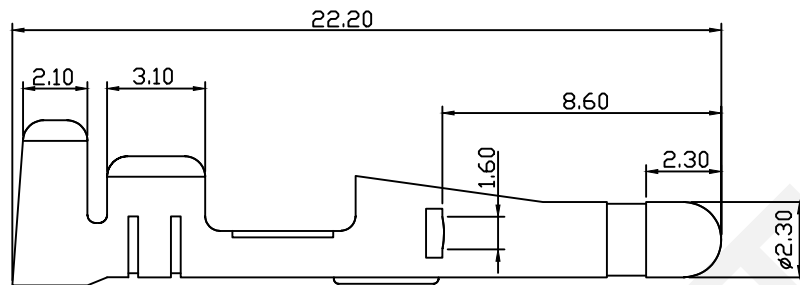
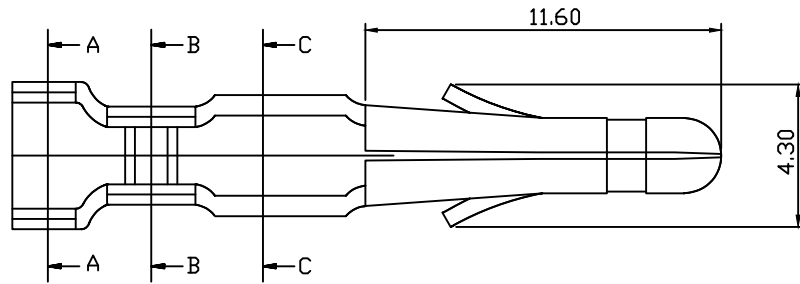
RoHS Compliance

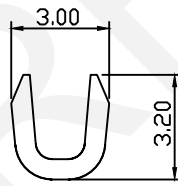

A-A



B-B

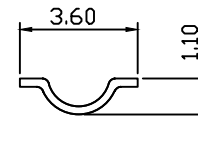

C-C

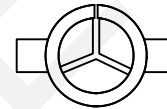

Material:
Terminal: Brass
Plating: Tin-Plated.
Applicable Wires: AWG #14~#24

Electrical Characteristics:
Rated Current: 12.0AMP
Voltage Rating: 600V AC, DC
Temperature Range: -40°C~+105°C
Insulator Resistance: 1000M Ω Min
Withstand Voltage: 1500V AC/DC
Contact Resistance: 10m Ω Max

Order Information:

RHTAY6.70-MT

Pitch: 6.70mm

Type:

- R-Male Housing
- P PF-Female Housing
- FT-Female Terminal
- MT-Male Terminal
- S-Straight Male Pin

 NINGBO RHT ELECTRONIC CO.,LTD

UNITS:mm	SHEET SIZE: A4			SCALE:---	DRWN BY PAN
0~3	3~18	18~50	50~120	CHK'D BY FENG	
±0.12	±0.15	±0.3	±0.5	APPR BY ZHAN	

6.70mm Pitch Wire To Board Connectors

THIRD ANGLE PROJECTION

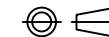

RHTAY6.70-MT

RoHS Compliance

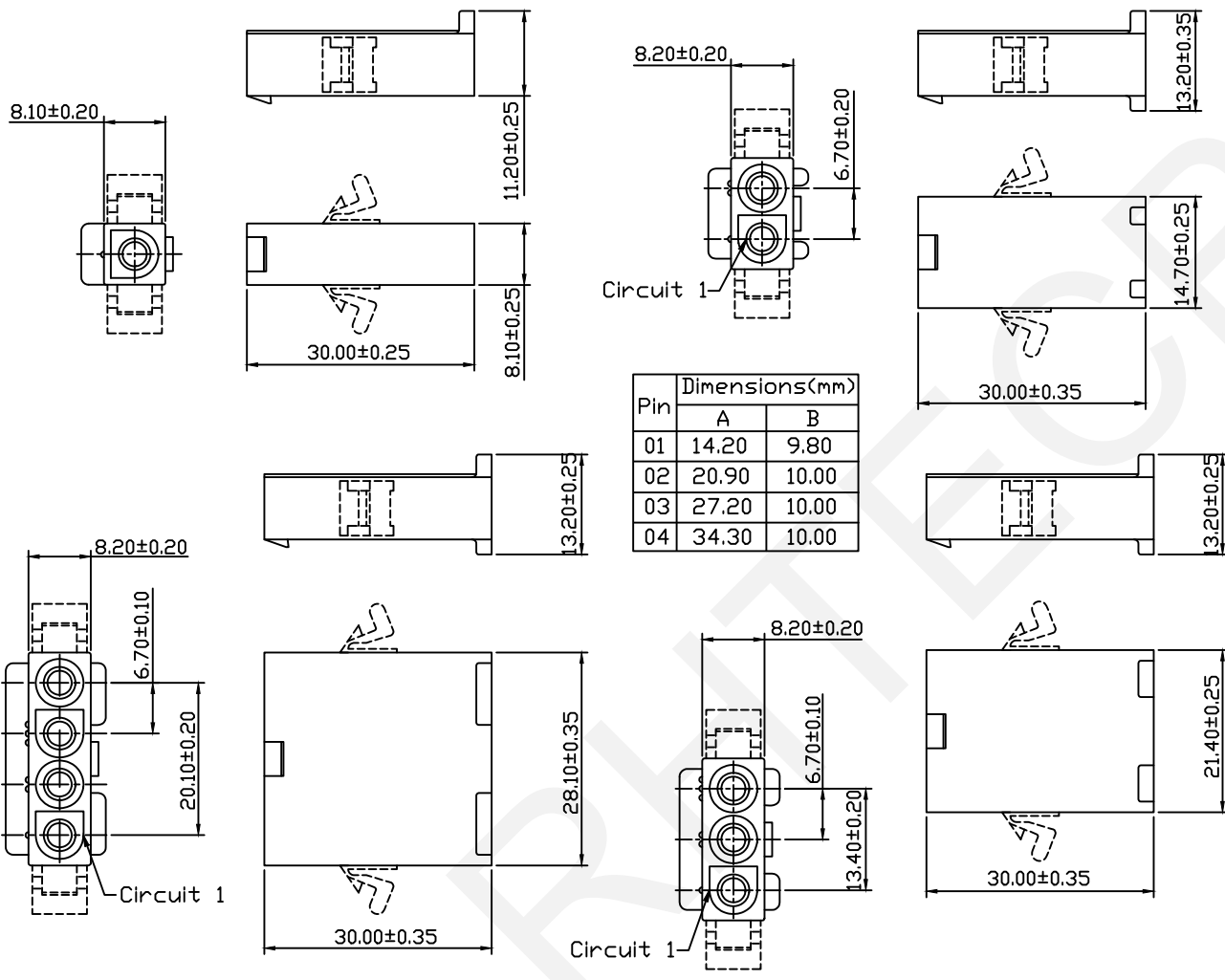

Pin	Dimensions(mm)	
	A	B
01	14.20	9.80
02	20.90	10.00
03	27.20	10.00
04	34.30	10.00

Material:
 Housing:PA66,UL94V-2,Natural
 Electrical Characteristics:
 Rated Current:12.0AMP
 Voltage Rating:600V AC,DC
 Temperature Range:-40°C~+105°C
 Insulator Resistance:1000MΩ Min
 Withstand Voltage:1500V AC/DC
 Contact Resistance:10mΩ Max

Order Information:
 RHTAY6.70-1xXX-P

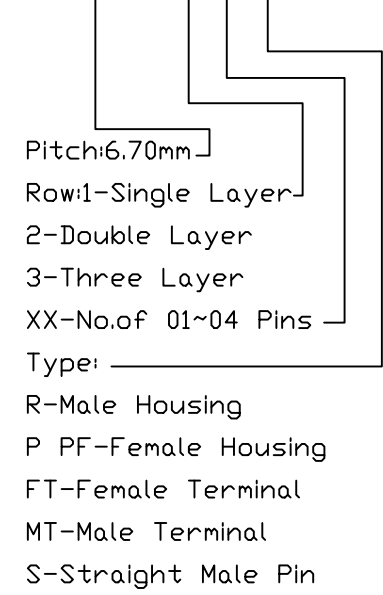

RHTECP NINGBO RHT ELECTRONIC CO.,LTD

UNITS:mm	SHEET SIZE: A4	SCALE:---	DRWN BY PAN
0~3	3~18	18~50	50~120
±0.12	±0.15	±0.3	±0.5
CHK'D BY FENG		APPR BY ZHAN	

6.70mm Pitch Wire To Board Connectors
 THIRD ANGLE PROJECTION

 RHTAY6.70-1xXX-P

RoHS Compliance

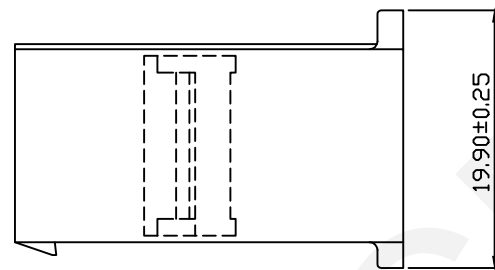
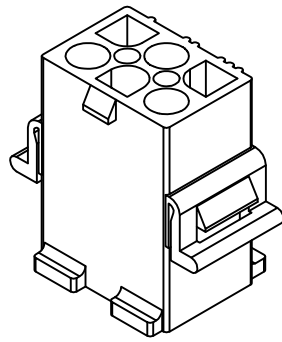

Material:
 Housing:PA66,UL94V-2,UL94V-0
 Color:Natural
 Electrical Characteristics:
 Rated Current:12.0AMP
 Voltage Rating:600V AC,DC
 Temperature Range:-40°C~+105°C
 Insulator Resistance:1000MΩ Min
 Withstand Voltage:1500V AC/DC
 Contact Resistance:10mΩ Max

Order Information:

RHTAY6.70-2x03-P

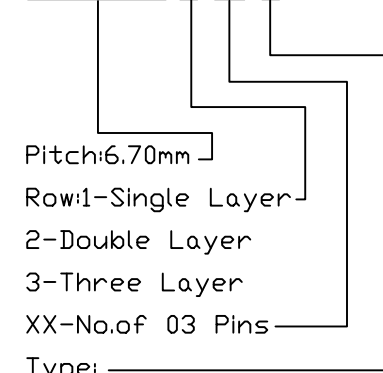

Type: _____
 R-Male Housing
 P PF-Female Housing
 FT-Female Terminal
 MT-Male Terminal
 S-Straight Male Pin

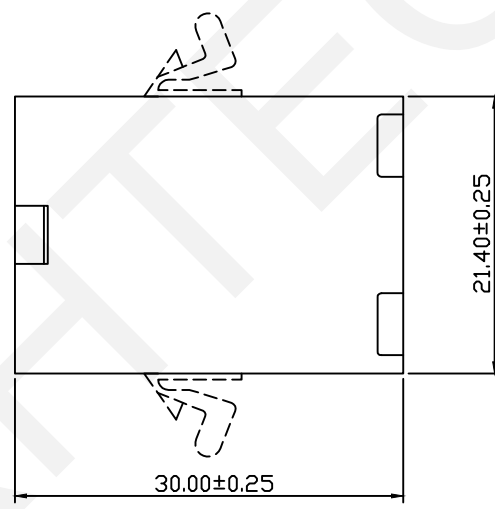
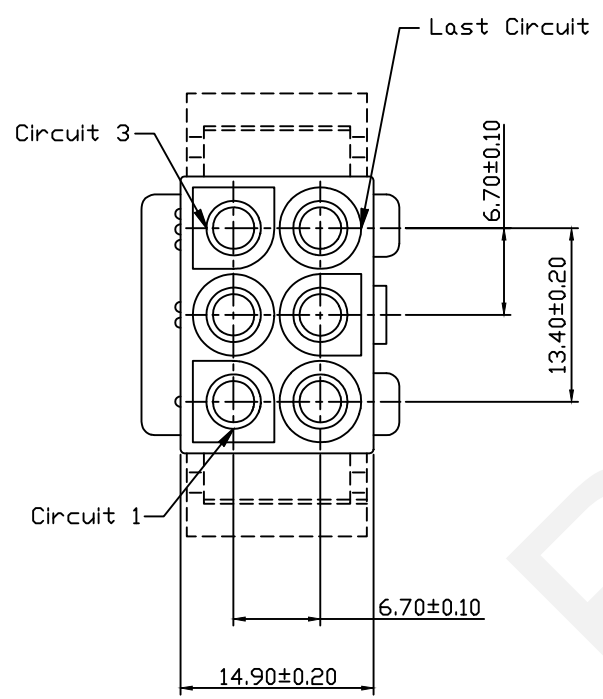

G	NINGBO RHT ELECTRONIC CO.,LTD	UNITS:mm	SHEET SIZE: A4	SCALE:---	DRWN BY PAN	6.70mm Pitch Wire To Board Connectors	
		0~3	3~18	18~50	50~120	CHK'D BY FENG	THIRD ANGLE PROJECTION
		±0.12	±0.15	±0.3	±0.5	APPR BY ZHAN	RHTAY6.70-2x03-P

RoHS Compliance

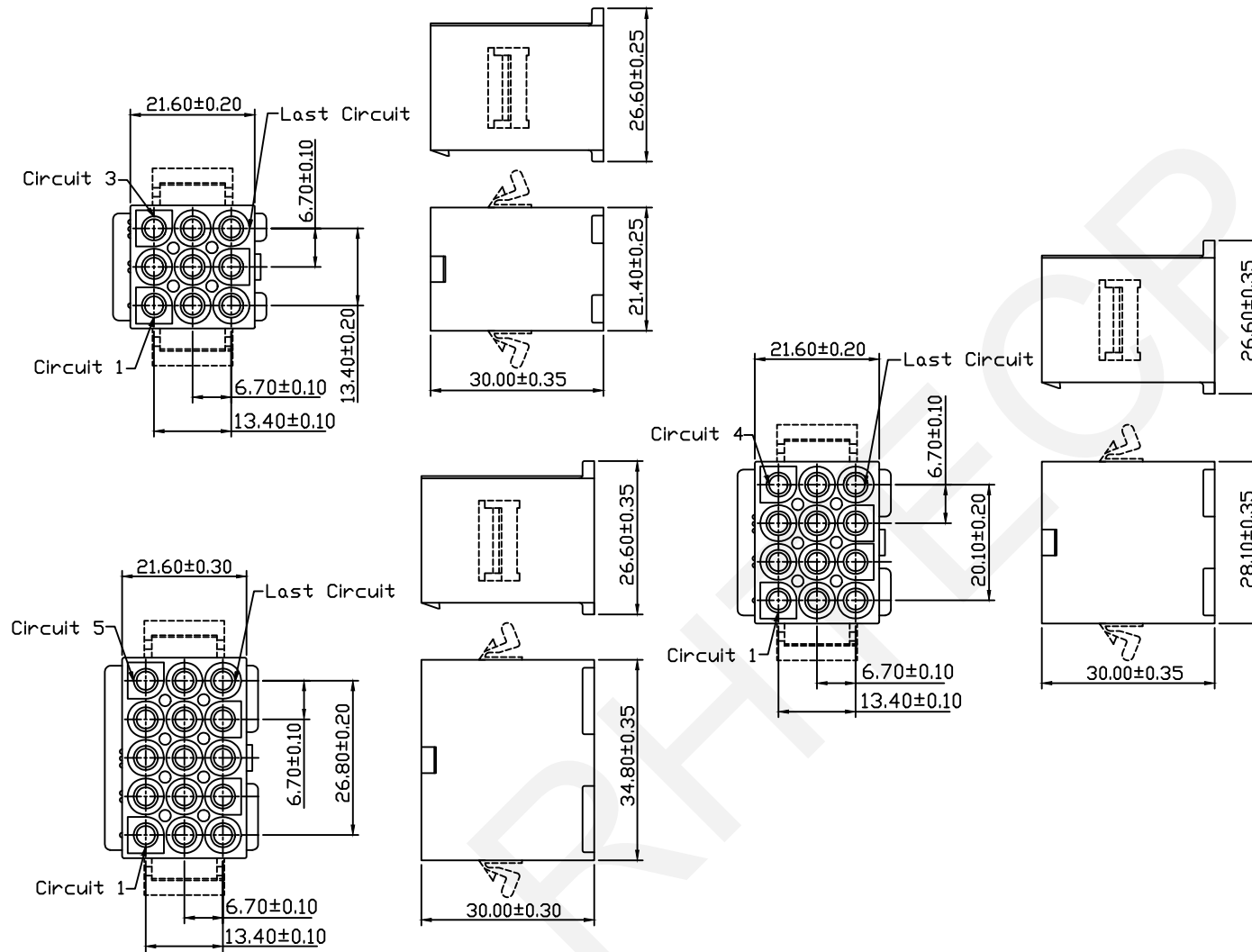

Material:

Housing: PA66, UL94V-2, UL94V-0

Color: Natural

Electrical Characteristics:

Rated Current: 12.0AMP

Voltage Rating: 600V AC, DC

Temperature Range: -40°C ~ +105°C

Insulator Resistance: 1000MΩ Min

Withstand Voltage: 1500V AC/DC

Contact Resistance: 10mΩ Max

Order Information:

RHTAY6.70-3xXX-P

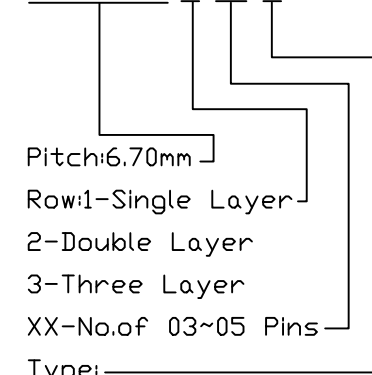

R-Male Housing

P PF-Female Housing

FT-Female Terminal

MT-Male Terminal

S-Straight Male Pin

RHTECP NINGBO RHT ELECTRONIC CO.,LTD

UNITS:mm	SHEET SIZE: A4				SCALE:---	DRWN BY PAN
0~3	3~18	18~50	50~120	CHK'D BY FENG	6.70mm Pitch Wire To Board Connectors	
±0.12	±0.15	±0.3	±0.5	APPR BY ZHAN	THIRD ANGLE PROJECTION	



RoHS Compliance

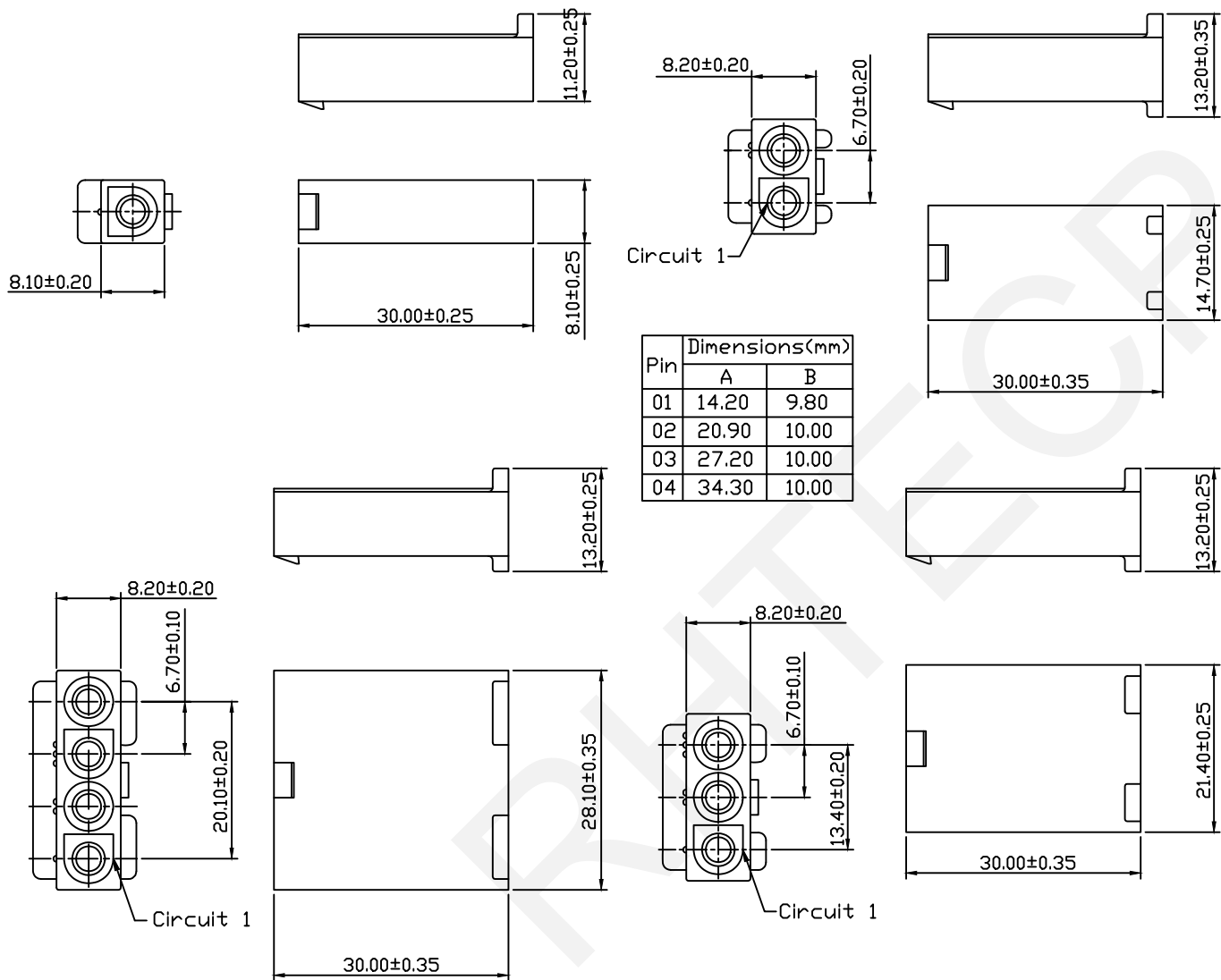

Material:
 Housing:PA66,UL94V-2,Natural
 Electrical Characteristics:
 Rated Current:12.0AMP
 Voltage Rating:600V AC,DC
 Temperature Range:-40°C~+105°C
 Insulator Resistance:1000MΩ Min
 Withstand Voltage:1500V AC/DC
 Contact Resistance:10mΩ Max

Order Information:
 RHTAY6.70-1xXX-PF

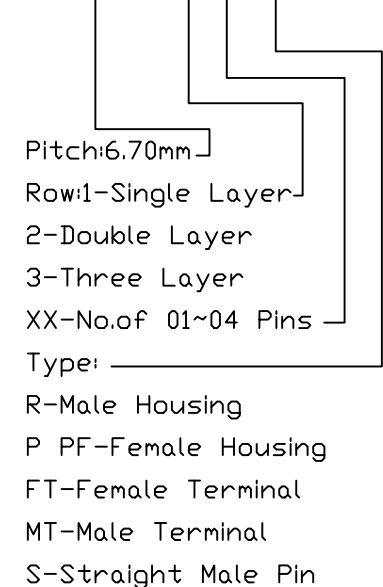

NINGBO RHT ELECTRONIC CO.,LTD

UNITS:mm	SHEET SIZE: A4	SCALE:---	DRWN BY PAN
0~3	3~18	18~50	50~120
±0.12	±0.15	±0.3	±0.5
CHK'D BY FENG		APPR BY ZHAN	

6.70mm Pitch Wire To Board Connectors
 THIRD ANGLE PROJECTION
 RHTAY6.70-1xXX-PF

RoHS Compliance

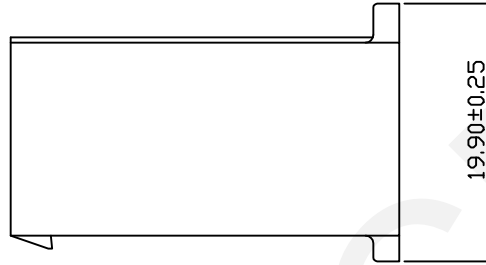
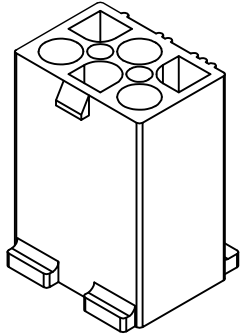

Material:
 Housing:PA66,UL94V-2,UL94V-0
 Color:Natural
 Electrical Characteristics:
 Rated Current:12.0AMP
 Voltage Rating:600V AC,DC
 Temperature Range:-40°C~+105°C
 Insulator Resistance:1000MΩ Min
 Withstand Voltage:1500V AC/DC
 Contact Resistance:10mΩ Max

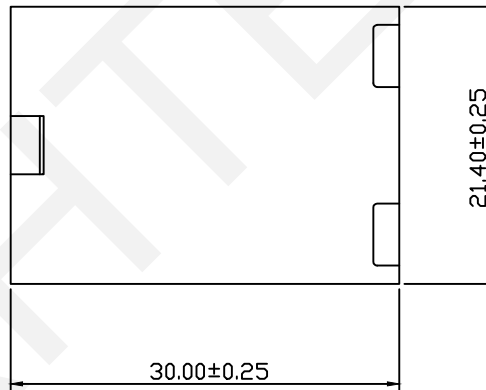
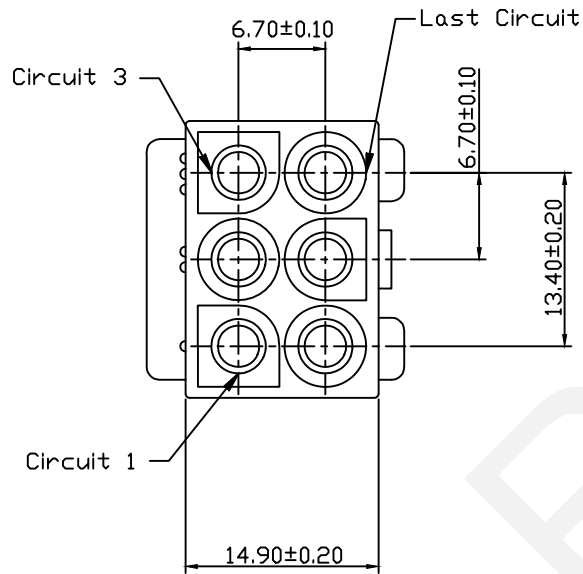

Order Information:

RHTAY6.70-2x03-PF

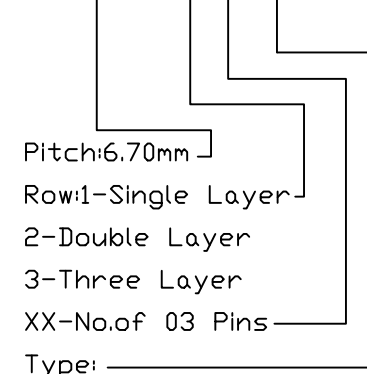

Pitch:6.70mm
 Row:1-Single Layer
 2-Double Layer
 3-Three Layer
 XX-No.of 03 Pins
 Type: _____
 R-Male Housing
 P PF-Female Housing
 FT-Female Terminal
 MT-Male Terminal
 S-Straight Male Pin

RHTECP NINGBO RHT ELECTRONIC CO.,LTD

UNITS:mm	SHEET SIZE: A4		SCALE:---	DRWN BY PAN
0~3	3~18	18~50	50~120	CHK'D BY FENG
±0.12	±0.15	±0.3	±0.5	APPR BY ZHAN

6.70mm Pitch Wire To Board Connectors

THIRD ANGLE PROJECTION

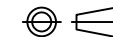

RHTAY6.70-2x03-PF

RoHS Compliance

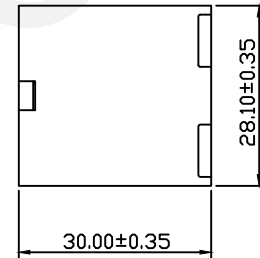
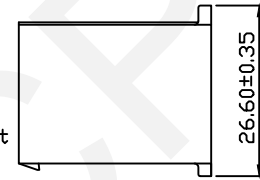
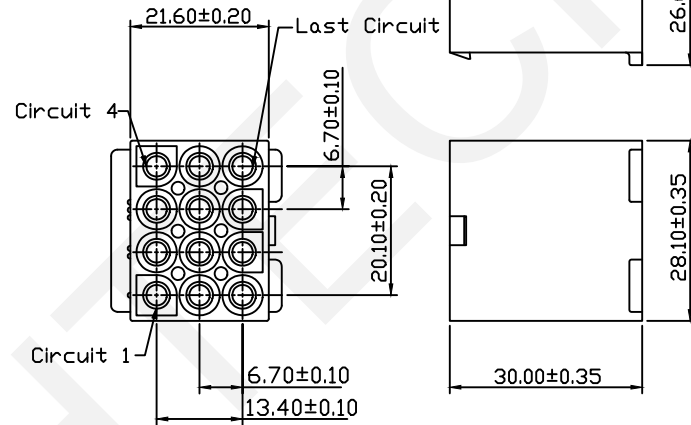
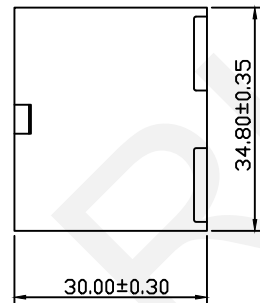
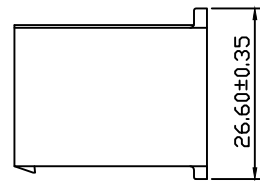
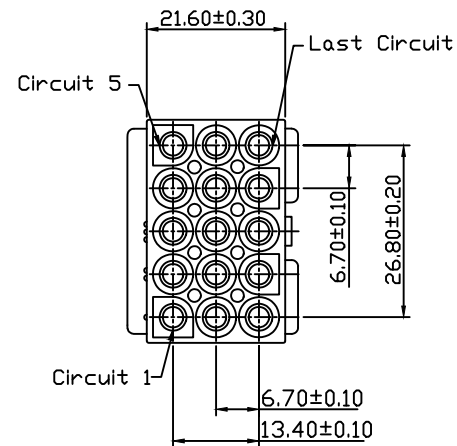
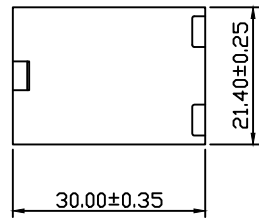
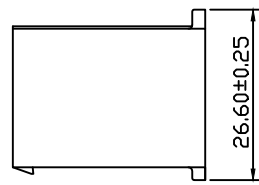
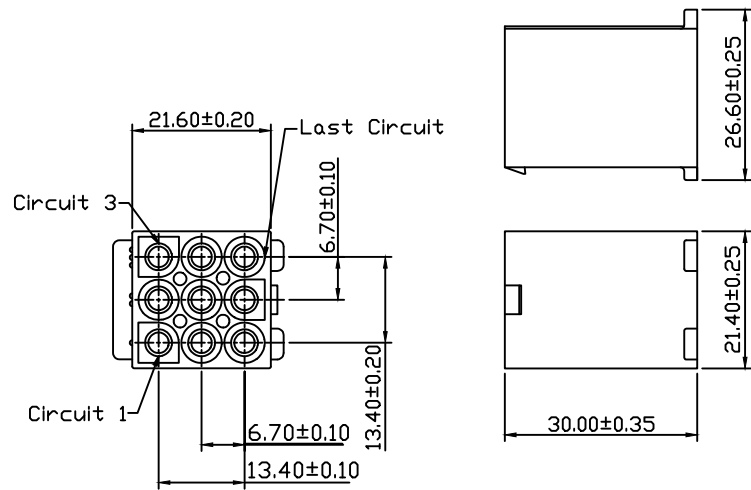

Material:
 Housing:PA66,UL94V-2,UL94V-0
 Color:Natural
 Electrical Characteristics:
 Rated Current:12.0AMP
 Voltage Rating:600V AC,DC
 Temperature Range:-40°C~+105°C
 Insulator Resistance:1000MΩ Min
 Withstand Voltage:1500V AC/DC
 Contact Resistance:10mΩ Max

Order Information:
 RHTAY6.70-3×XX-PF

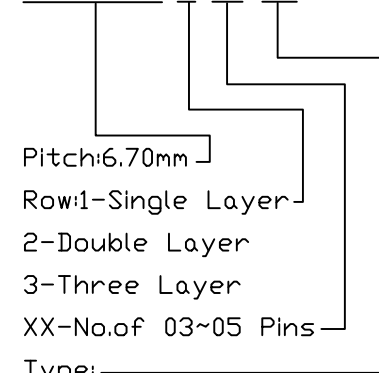

Pitch:6.70mm
 Row:1-Single Layer
 2-Double Layer
 3-Three Layer
 XX-No.of 03~05 Pins
 Type: _____
 R-Male Housing
 P PF-Female Housing
 FT-Female Terminal
 MT-Male Terminal
 S-Straight Male Pin

RHTECP NINGBO RHT ELECTRONIC CO.,LTD

UNITS:mm	SHEET SIZE: A4	SCALE:---	DRWN BY PAN
0~3	3~18	18~50	50~120
±0.12	±0.15	±0.3	±0.5
CHK'D BY FENG		APPR BY ZHAN	

6.70mm Pitch Wire To Board Connectors

THIRD ANGLE PROJECTION

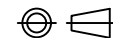

RHTAY6.70-3×XX-PF

RoHS Compliance

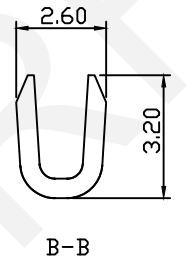
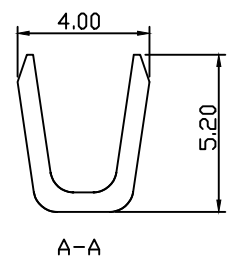
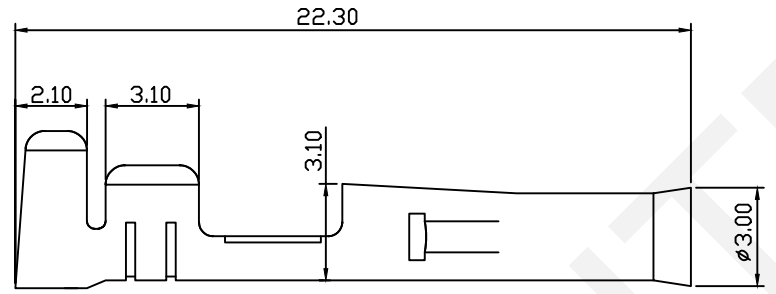
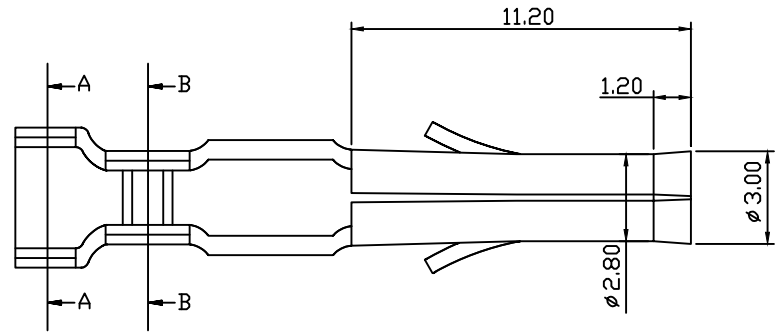

Material:
Terminal: Brass
Plating: Tin-Plated.
Applicable Wires: AWG #14~#24

Electrical Characteristics:
Rated Current: 12.0AMP
Voltage Rating: 600V AC, DC
Temperature Range: -40°C~+105°C
Insulator Resistance: 1000MΩ Min
Withstand Voltage: 1500V AC/DC
Contact Resistance: 10mΩ Max

Order Information:
RHTAY6.70-FT

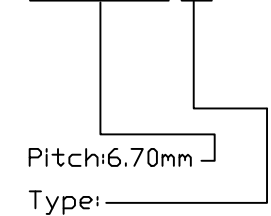

R-Male Housing
P PF-Female Housing
FT-Female Terminal
MT-Male Terminal
S-Straight Male Pin



NINGBO RHT ELECTRONIC CO.,LTD

UNITS:mm	SHEET SIZE: A4			SCALE:---	DRWN BY PAN
0~3	3~18	18~50	50~120	CHK'D BY FENG	
±0.12	±0.15	±0.3	±0.5	APPR BY ZHAN	

6.70mm Pitch Wire To Board Connectors

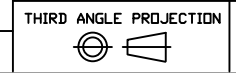

RHTAY6.70-FT

RoHS Compliance

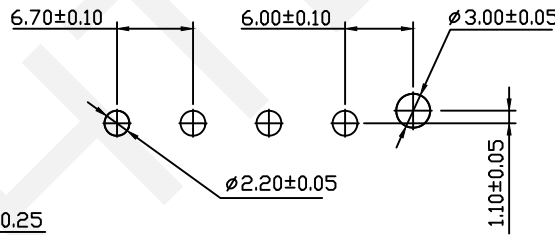
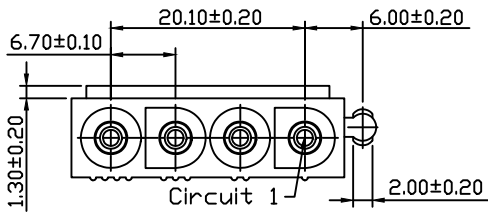
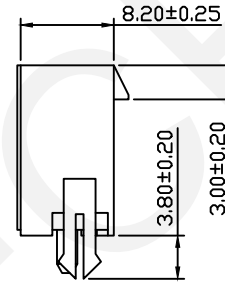
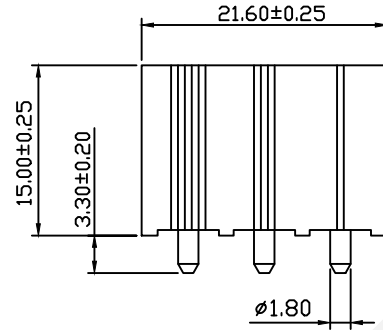
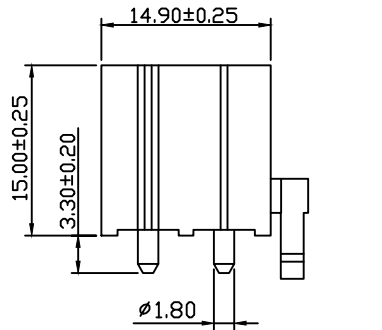
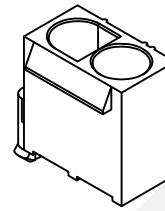
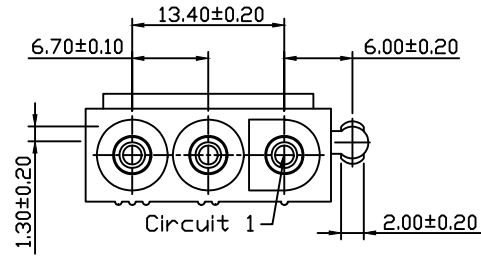
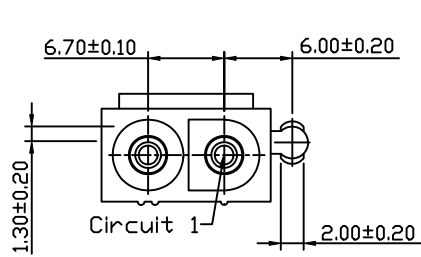

PCB LAYOUT

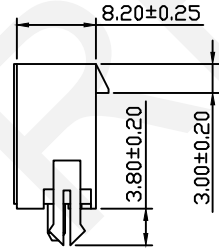
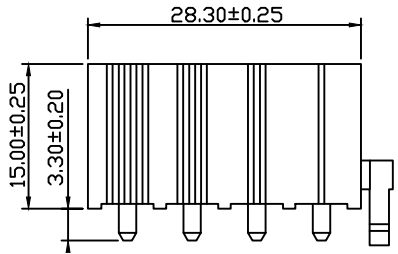

Material:
 Housing: PA66, UL94V-2, Natural
 Contact: Brass
 Plating: Tin Plated Over Nickel
 Electrical Characteristics:
 Rated Current: 12.0AMP
 Voltage Rating: 600V AC, DC
 Temperature Range: -40°C ~ +105°C
 Insulator Resistance: 1000MΩ Min
 Withstand Voltage: 1500V AC/DC
 Contact Resistance: 10mΩ Max

Order Information:
 RHTAY6.70-1×XX-S

Pitch: 6.70mm
 Row: 1-Single Layer
 2-Double Layer
 3-Three Layer
 XX-No. of 02~04 Pins

Type: _____
 R-Male Housing
 P PF-Female Housing
 FT-Female Terminal
 MT-Male Terminal
 S-Straight Male Pin

NINGBO RHT ELECTRONIC CO.,LTD

UNITS:mm	SHEET SIZE: A4		SCALE:---	DRWN BY PAN
0~3	3~18	18~50	50~120	CHK'D BY FENG
±0.12	±0.15	±0.3	±0.5	APPR BY ZHAN

6.70mm Pitch Wire To Board Connectors

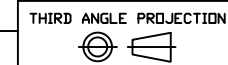

RHTAY6.70-1×XX-S

RoHS Compliance

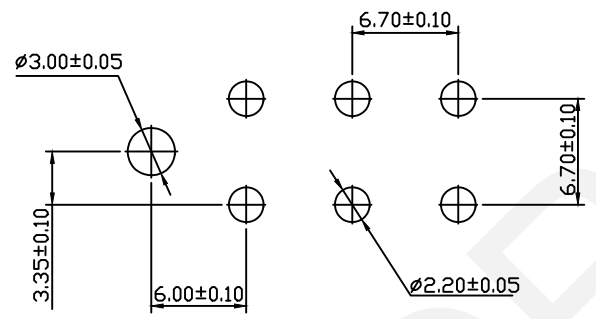
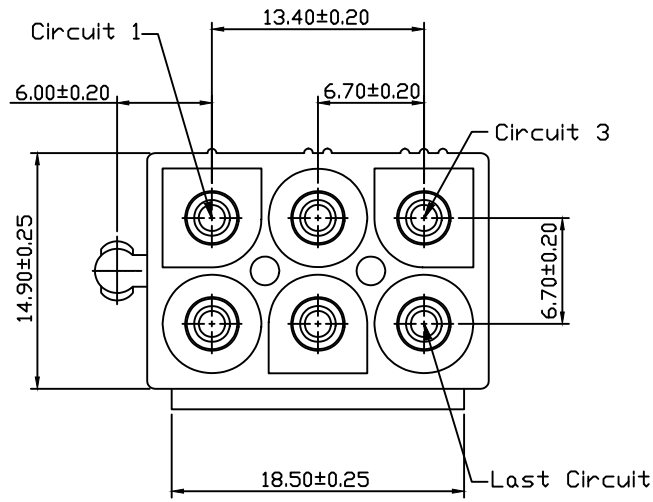

PCB LAYOUT

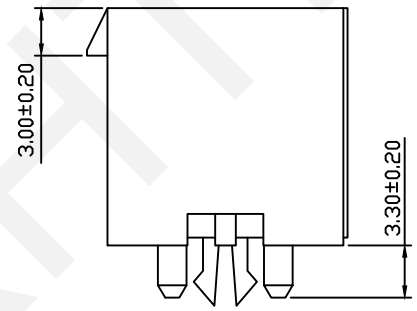
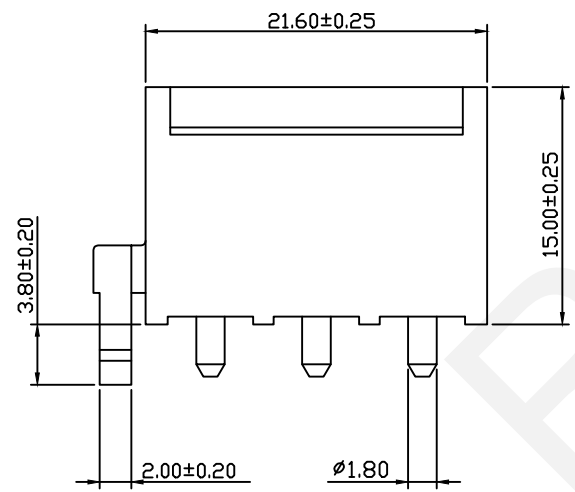

Material:
 Housing: PA66, UL94V-2, Natural
 Contact: Brass
 Plating: Tin Plated Over Nickel
 Electrical Characteristics:
 Rated Current: 12.0AMP
 Voltage Rating: 600V AC, DC
 Temperature Range: -40°C ~ +105°C
 Insulator Resistance: 1000MΩ Min
 Withstand Voltage: 1500V AC/DC
 Contact Resistance: 10mΩ Max

Order Information:

RHTAY6.70-2xXX-S
 Pitch: 6.70mm
 Row: 1-Single Layer
 2-Double Layer
 3-Three Layer
 XX-No. of 06 Pins
 Type: _____
 R-Male Housing
 P PF-Female Housing
 FT-Female Terminal
 MT-Male Terminal
 S-Straight Male Pin

RHTECP NINGBO RHT ELECTRONIC CO.,LTD

UNITS:mm	SHEET SIZE: A4	SCALE:---	DRWN BY PAN
0~3	3~18	18~50	50~120
±0.12	±0.15	±0.3	±0.5
CHK'D BY FENG		APPR BY ZHAN	

6.70mm Pitch Wire To Board Connectors
 THIRD ANGLE PROJECTION

 RHTAY6.70-2xXX-S

RoHS Compliance

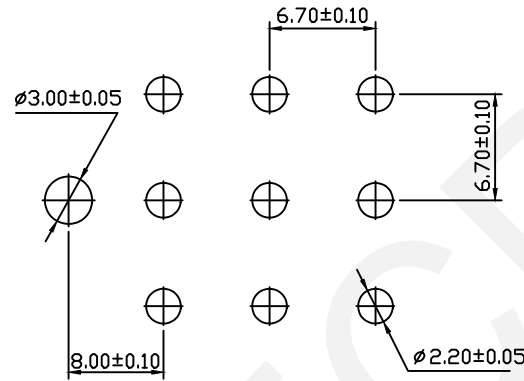
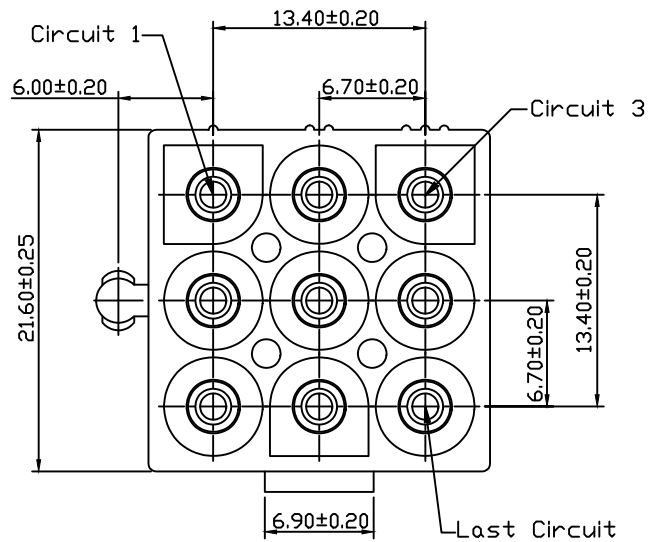

PCB LAYOUT

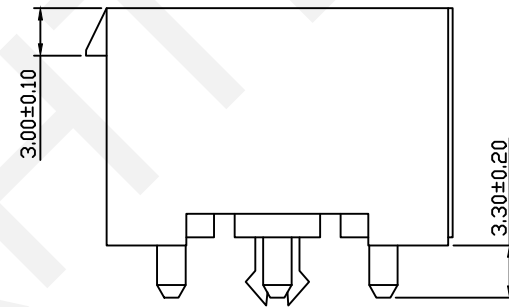
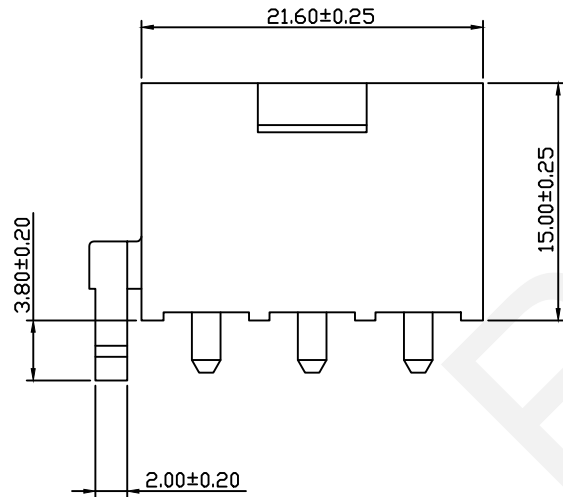

Material:

Housing: PA66, UL94V-2, Natural

Contact: Brass

Plating: Tin Plated Over Nickel

Electrical Characteristics:

Rated Current: 12.0AMP

Voltage Rating: 600V AC, DC

Temperature Range: -40°C ~ +105°C

Insulator Resistance: 1000MΩ Min

Withstand Voltage: 1500V AC/DC

Contact Resistance: 10mΩ Max

Order Information:

RHTAY6.70-3xXX-S

Pitch: 6.70mm

Row: 1-Single Layer

2-Double Layer

3-Three Layer

XX-No. of 09 Pins

Type:

R-Male Housing

P-PF-Female Housing

FT-Female Terminal

MT-Male Terminal

S-Straight Male Pin



NINGBO RHT ELECTRONIC CO.,LTD

UNITS:mm	SHEET SIZE: A4		SCALE:---	DRWN BY PAN
0~3	3~18	18~50	50~120	CHK'D BY FENG
±0.12	±0.15	±0.3	±0.5	APPR BY ZHAN

6.70mm Pitch Wire To Board Connectors

THIRD ANGLE PROJECTION

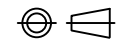

RHTAY6.70-3xXX-S