

RoHS Compliance

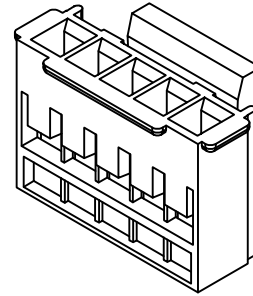
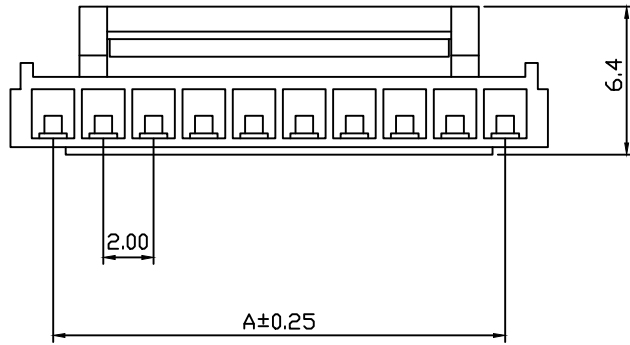

Material:
Housing: PA66 UL94V-2

Electrical Characteristics:
 Rated Current : 3.0AMP
 Voltage Rating : 250V AC,DC
 Temperature Range: -25°C~+85°C
 Insulator Resistance: 500MΩ/Min.
 Withstand Voltage: 800V AC/DC
 Contact Resistance: 20MΩ/Max

Pin	Dimension(mm)	
	A	B
02	2.00	4.60
03	4.00	6.60
04	6.00	8.60
05	8.00	10.60
06	10.00	12.60
07	12.00	14.60
08	14.00	16.60
09	16.00	18.60
10	18.00	20.60
11	20.00	22.60
12	22.00	24.60
13	24.00	26.60
14	26.00	28.60
15	28.00	30.60
16	30.00	32.60

Order Information
RHTAYL2-2.00-XX-H

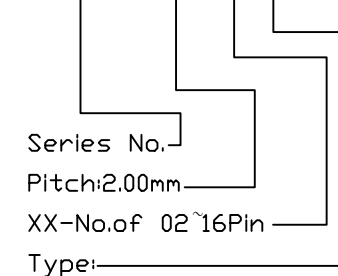

Type: _____
 T-Terminal H-Hosing
 S-Straight Male Pin
 R-Right Angle Male Pin
 VM-Vertical SMT Pin
 RM-Horizontal SMT Pin

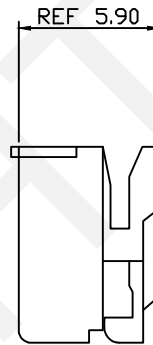
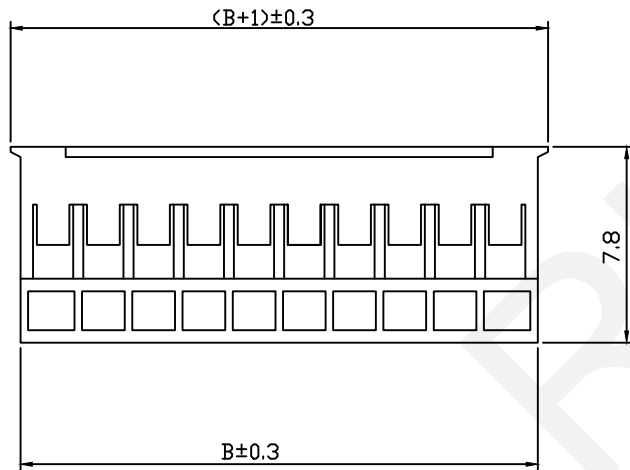

UNITS:mm	SHEET SIZE: A4				SCALE:---	DRWN BY PAN
0~3	3~18	18~50	50~120	CHK'D BY FENG	2.00mm Pitch PH With Lock Type Wire to Board Connector	
±0.12	±0.15	±0.3	±0.5	APPR BY ZHAN	THIRD ANGLE PROJECTION	RHTAYL2-2.00-XX-H

RHTECP NINGBO RHT ELECTRONIC CO.,LTD



RHTAYL2-2.00-XX-H

RoHS Compliance

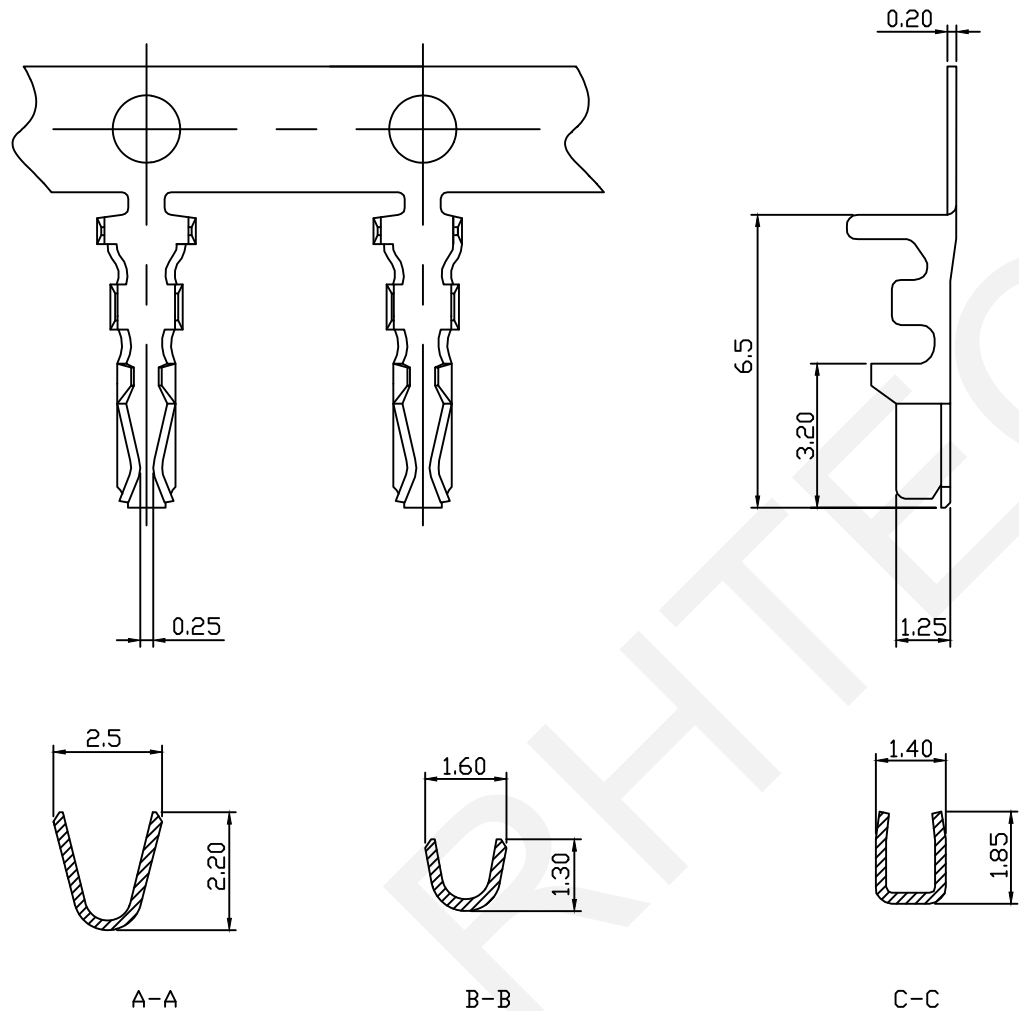

Material:
 Terminal: Phosphor Bronze
 Plating: Tin plated Over Nickel
 Applicable Wires: AWG #28~#22
 Insulation O.D: 1.2 To 1.60mm
 Qty/Reel: 12000 PCS

Electrical Characteristics:
 Rated Current: 3.0AMP
 Voltage Rating: 250V AC,DC
 Temperature Range: -25°C~+85°C
 Insulator Resistance: 500MΩ Min
 Withstand Voltage: 800V AC/DC
 Contact Resistance: 20mΩ Max

Order Information

RHTAYL2-2.00-T

Series No. _____
 Pitch: 2.00mm _____
 Type: _____

T-Terminal H-Hosing
 S-Straight Male Pin
 R-Right Angle Male Pin
 VM-Vertical SMT Pin
 RM-Horizontal SMT Pin

RHTECP NINGBO RHT ELECTRONIC CO.,LTD

UNITS:mm	SHEET SIZE: A4	SCALE:---	DRWN BY PAN
0~3	3~18	18~50	50~120
±0.12	±0.15	±0.3	±0.5

CHK'D BY FENG
 APPR BY ZHAN

2.00mm Pitch PH Type
 Wire To Board Connector

THIRD ANGLE PROJECTION

RHTAYL2-2.00-T

RoHS Compliance

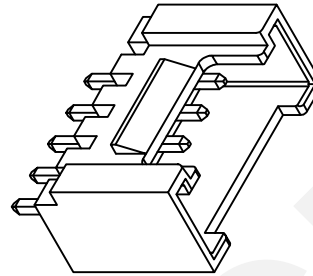
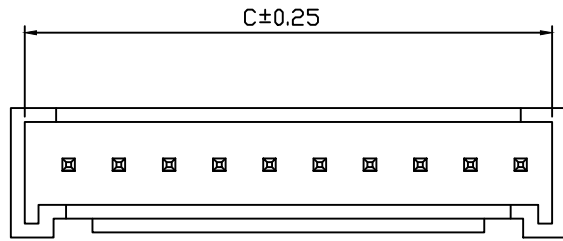

Material:
Housing: PA66 UL94V-2
Contact: Brass
Plating: Tin plated

Electrical Characteristics:
Rated Current : 3.0AMP
Voltage Rating : 250V AC,DC
Temperature Range: -25°C~+85°C
Insulator Resistance: 500MΩ/Min.
Withstand Voltage: 800V AC/DC
Contact Resistance: 20MΩ/Max

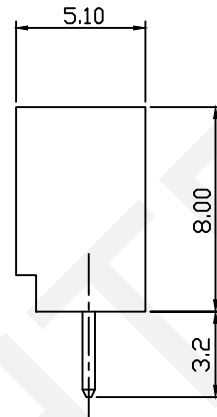
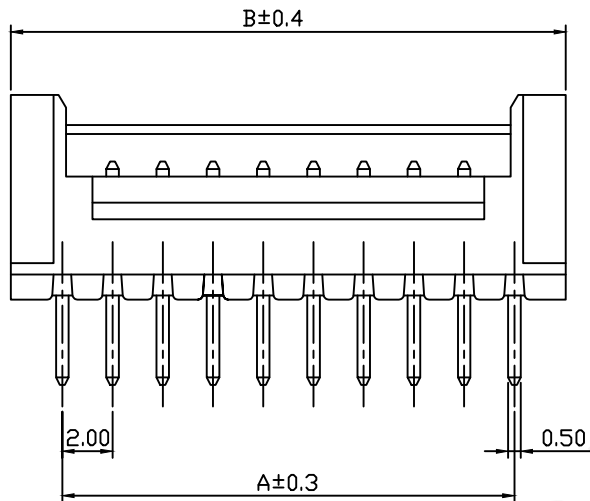

Pin	Dimension(mm)		
	A	B	C
02	2.00	6.00	4.90
03	4.00	8.00	6.90
04	6.00	10.00	8.90
05	8.00	12.00	10.90
06	10.00	14.00	12.90
07	12.00	16.00	14.90
08	14.00	18.00	16.90
09	16.00	20.00	18.90
10	18.00	22.00	20.90
11	20.00	24.00	22.90
12	22.00	26.00	24.90
13	24.00	28.00	26.90
14	26.00	30.00	28.90
15	28.00	32.00	30.90
16	30.00	34.00	32.90

Order Information

RHTAYL2-2.00-XX-S

Series No. _____
Pitch: 2.00mm _____
XX-No. of 02~16Pin _____
Type: _____
T-Terminal H-Hosing
S-Straight Male Pin
R-Right Angle Male Pin
VM-Vertical SMT Pin
RM-Horizontal SMT Pin

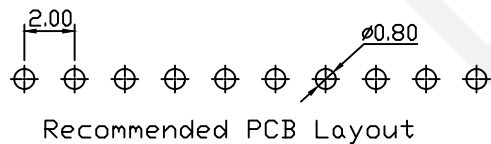

UNITS:mm	SHEET SIZE: A4				SCALE:---	DRWN BY PAN
0~3	3~18	18~50	50~120	CHK'D BY FENG	2.00mm Pitch PH With Lock Type Wire to Board Connector	
±0.12	±0.15	±0.3	±0.5	APPR BY ZHAN	THIRD ANGLE PROJECTION	RHTAYL2-2.00-XX-S



NINGBO RHT ELECTRONIC CO.,LTD



RHTAYL2-2.00-XX-S

RoHS Compliance

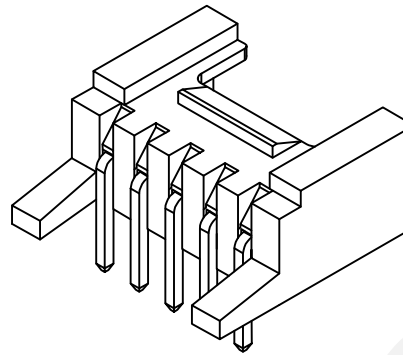
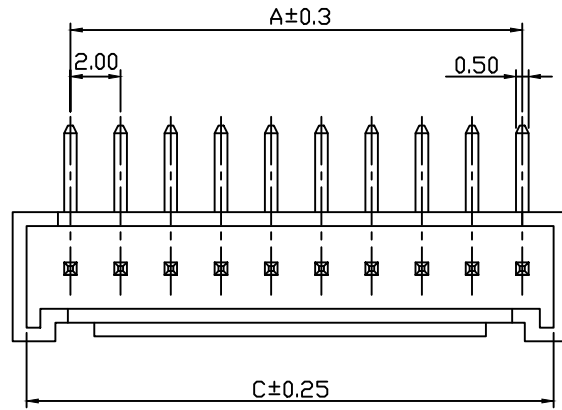

Material:
Housing:PA66 UL94V-2
Contact:Brass
Plating: Tin plated

Electrical Characteristics:
Rated Current : 3.0AMP
Voltage Rating : 250V AC,DC
Temperature Range: -25°C~+85°C
Insulator Resistance: 1000MΩ/Min.
Withstand Voltage: 1000V AC/DC
Contact Resistance: 30MΩ/Max

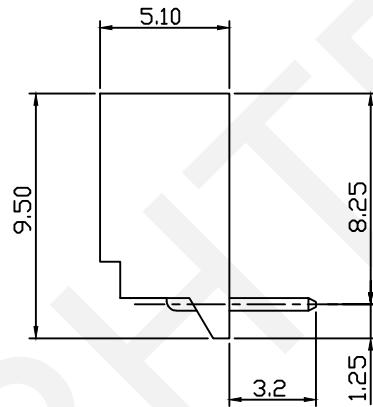
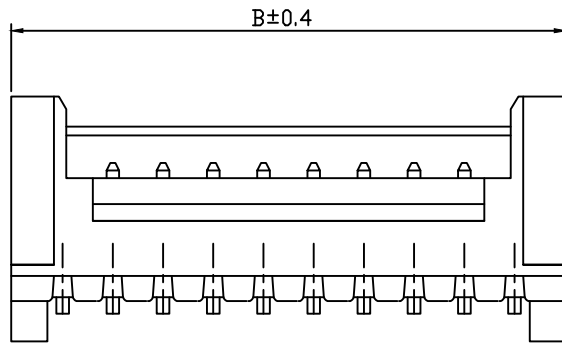

Pin	Dimension(mm)		
	A	B	C
02	2.00	6.00	4.90
03	4.00	8.00	6.90
04	6.00	10.00	8.90
05	8.00	12.00	10.90
06	10.00	14.00	12.90
07	12.00	16.00	14.90
08	14.00	18.00	16.90
09	16.00	20.00	18.90
10	18.00	22.00	20.90
11	20.00	24.00	22.90
12	22.00	26.00	24.90
13	24.00	28.00	26.90
14	26.00	30.00	28.90
15	28.00	32.00	30.90
16	30.00	34.00	32.90

Order Information

RHTAYL2-2.00-XX-R

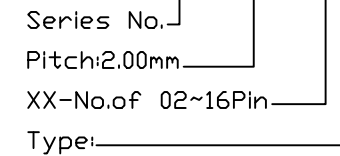

Type: _____
T-Terminal H-Hosing
S-Straight Male Pin
R-Right Angle Male Pin
VM-Vertical SMT Pin
RM-Horizontal SMT Pin

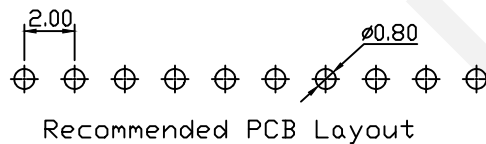

UNITS:mm	SHEET SIZE: A4			SCALE:---	DRWN BY PAN
0~3	3~18	18~50	50~120	CHK'D BY FENG	
±0.12	±0.15	±0.3	±0.5	APPR BY ZHAN	

2.00mm Pitch PH With Lock Type
Wire to Board Connector

THIRD ANGLE PROJECTION

RHTAYL2-2.00-XX-R

RHTECP NINGBO RHT ELECTRONIC CO.,LTD

RoHS Compliance

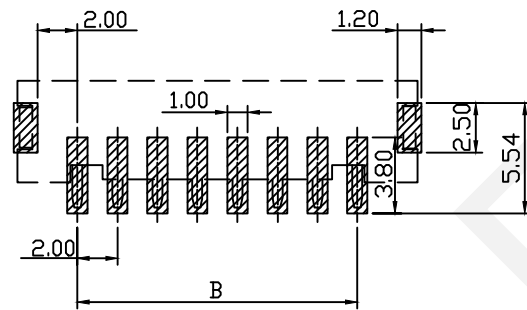
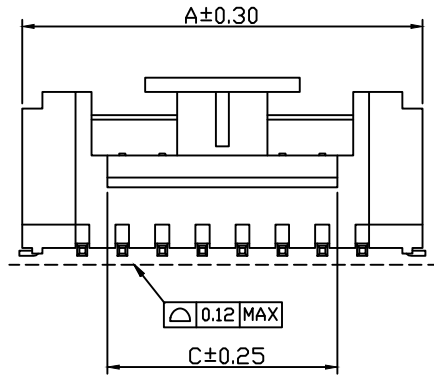
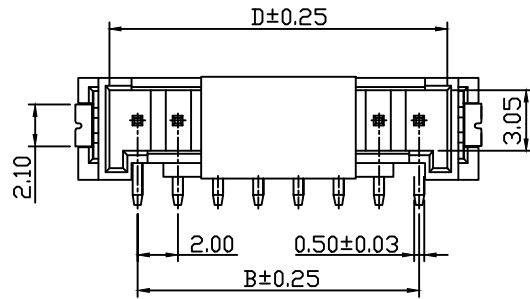

Recommended PCB Layout

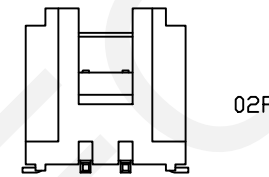
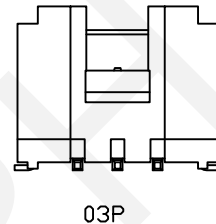
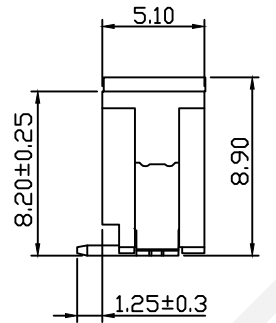

02P

Order Information
RHTAYL2-2.00-XX-VM

Series No. _____
Pitch: 2.00mm _____
XX-No. of 02~16Pin _____
Type: _____
T-Terminal H-Housing
S-Straight Male Pin
R-Right Angle Male Pin
VM-Vertical SMT Pin
RM-Horizontal SMT Pin

Material:
Housing: LCP, UL94V-0
Contact: Brass
Solder Tabs: Phosphor Bronze
Plating: Tin Plated Over Nickel

Electrical Characteristics:
Rated Current : 2.0AMP
Voltage Rating : 250V AC,DC
Temperature Range: -25°C~+85°C
Insulator Resistance: 1000MΩ/Min.
Withstand Voltage: 1000V AC/DC
Contact Resistance: 30MΩ/Max

Pin	Dimension(mm)			
	A	B	C	D
02	8.00	2.00	2.70	4.75
03	10.00	4.00	3.20	6.75
04	12.00	6.00	3.50	8.90
05	14.00	8.00	5.50	10.90
06	16.00	10.00	7.50	12.90
07	18.00	12.00	9.50	14.90
08	20.00	14.00	11.50	16.90
09	22.00	16.00	13.50	18.90
10	24.00	18.00	15.50	20.90
11	26.00	20.00	15.50	22.90
12	28.00	22.00	15.50	24.90
13	30.00	24.00	15.50	26.90
14	32.00	26.00	15.50	28.90
15	34.00	28.00	15.50	30.90
16	36.00	30.00	15.50	32.90

NINGBO RHT ELECTRONIC CO.,LTD

UNITS:mm SHEET SIZE: A4 SCALE: --- DRWN BY PAN
0~3 3~18 18~50 50~120 CHK'D BY FENG
±0.12 ±0.15 ±0.3 ±0.5 APPR BY ZHAN

2.00mm Pitch PH With Lock Type
Wire to Board Connector
THIRD ANGLE PROJECTION
 RHTAYL2-2.00-XX-VM

RoHS Compliance

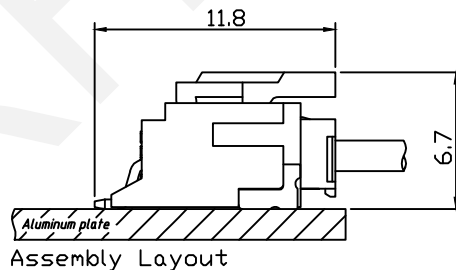
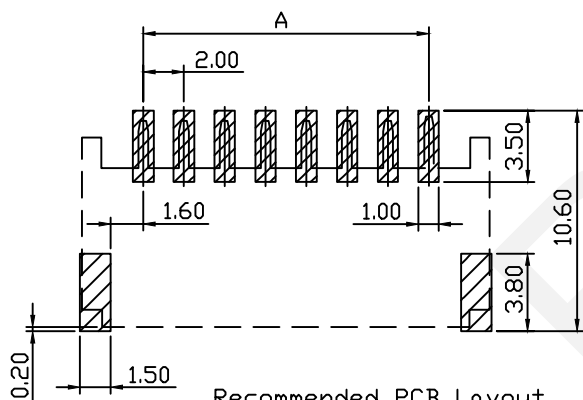
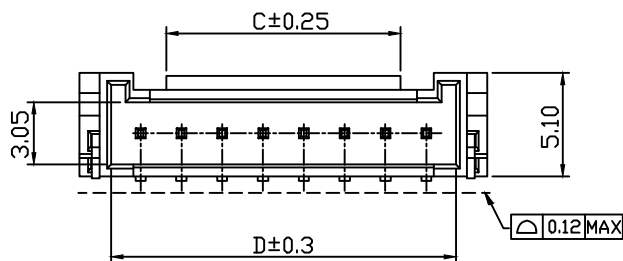
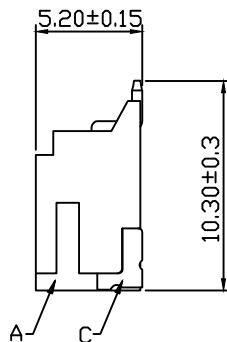
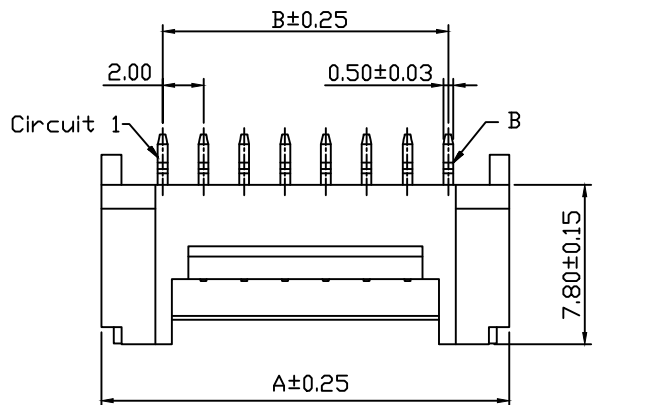

Order Information
RHTAYL2-2.00-XX-RM

Series No. _____
Pitch: 2.00mm
XX-No. of 02~16Pin
Type: _____
T-Terminal H-Hosing
S-Straight Male Pin
R-Right Angle Male Pin
VM-Vertical SMT Pin
RM-Horizontal SMT Pin

Material:

Housing: LCP, UL94V-0
Contact: Brass
Solder Nail: Phosphor Bronze
Plating: Tin Plated Over Nickel

Electrical Characteristics:

Rated Current : 2.0AMP
Voltage Rating : 250V AC, DC
Temperature Range: -25°C ~ +85°C
Insulator Resistance: 1000MΩ/Min.
Withstand Voltage: 1000V AC/DC
Contact Resistance: 20MΩ/Max

Pin	Dimension(mm)			
	A	B	C	D
02	8.00	2.00	2.70	4.75
03	10.00	4.00	3.20	6.75
04	12.00	6.00	3.50	8.90
05	14.00	8.00	5.50	10.90
06	16.00	10.00	7.50	12.90
07	18.00	12.00	9.50	14.90
08	20.00	14.00	11.50	16.90
09	22.00	16.00	13.50	18.90
10	24.00	18.00	15.50	20.90
11	26.00	20.00	15.50	22.90
12	28.00	22.00	15.50	24.90
13	30.00	24.00	15.50	26.90
14	32.00	26.00	15.50	28.90
15	34.00	28.00	15.50	30.90
16	36.00	30.00	15.50	32.90

NINGBO RHT ELECTRONIC CO.,LTD

UNITS:mm SHEET SIZE: A4 SCALE: ---
0~3 3~18 18~50 50~120
±0.12 ±0.15 ±0.3 ±0.5

DRWN BY PAN
CHK'D BY FENG
APPR BY ZHAN

2.00mm Pitch PH With Lock Type
Wire to Board Connector
THIRD ANGLE PROJECTION
 RHTAYL2-2.00-XX-RM