

RoHS Compliance

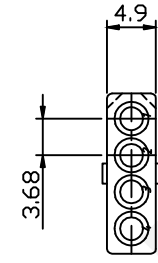

Material:
Housing: PA66,UL94V-2

Electrical Characteristics:
Rated Current : 5.0AMP
Temperature Range: -40°C~+105°C
Insulator Resistance: 1000MΩ/Min.
Withstanding Voltage: 1500V AC/Minute

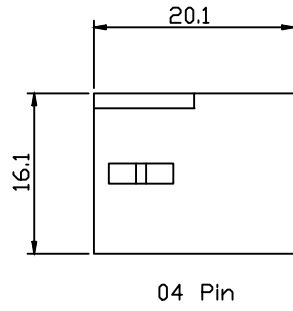
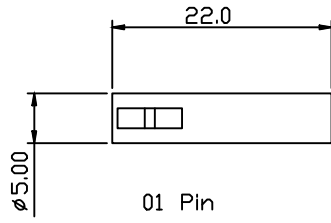
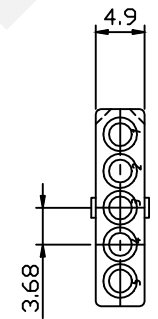
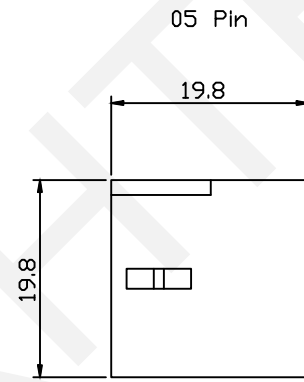
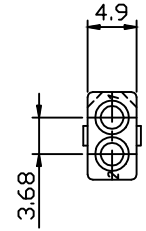
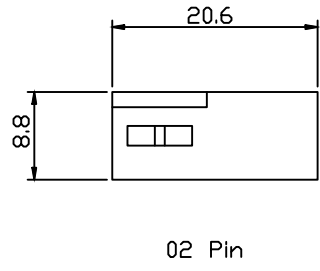

Order Information:
RHTAY3.68-1xXX-FH

Pitch:3.68mm
Row

1-Single Layer
2-Double Layer
3-Three Layer
XX-No.of 01~05pins

Type:

FH/RFH-Female Hosing
MH/RMH-Male Hosing
FT-Female Terminal
MT-Male Terminal

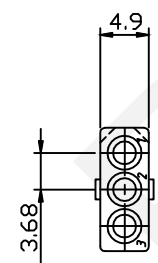
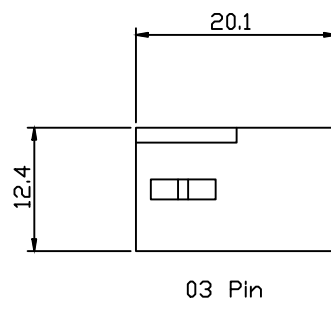

NINGBO RHT ELECTRONIC CO.,LTD

UNITS:mm	SHEET SIZE: A4		SCALE:---		DRWN BY PAN
0~3	3~18	18~50	50~120	CHK'D BY FENG	
±0.12	±0.15	±0.3	±0.5	APPR BY ZHAN	

3.68mm Pitch 5500 5600
Wire To Wire Connector

THIRD ANGLE PROJECTION

RHTAY3.68-1xXX-FH

RoHS Compliance

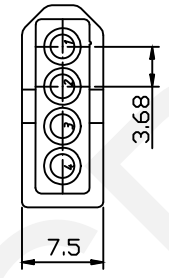
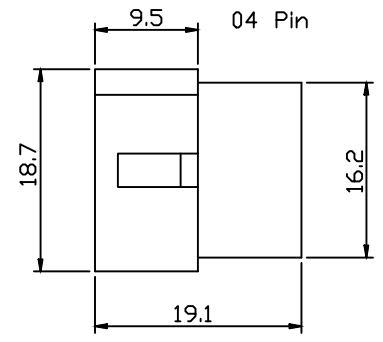
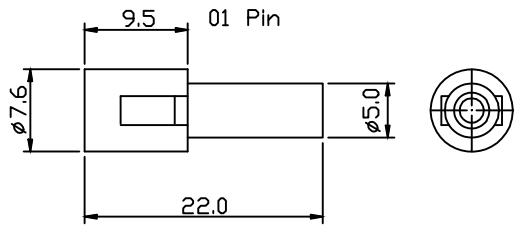

Material:
Housing: PA66,UL94V-2

Electrical Characteristics:
Rated Current : 5.0A AC/DC
Voltage Rating : 250V AC/DC
Temperature Range: -40°C~+105°C
Insulator Resistance: 1000MΩ/Min.
Withstanding Voltage: 1500V AC/Minute

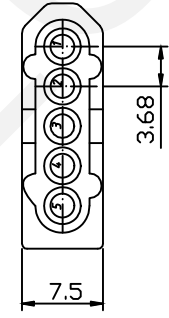
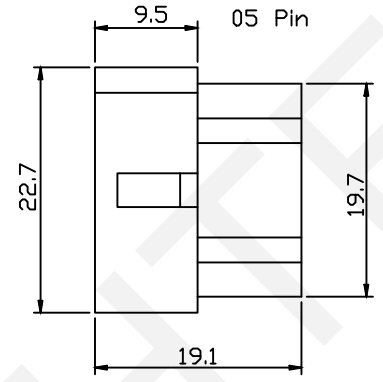
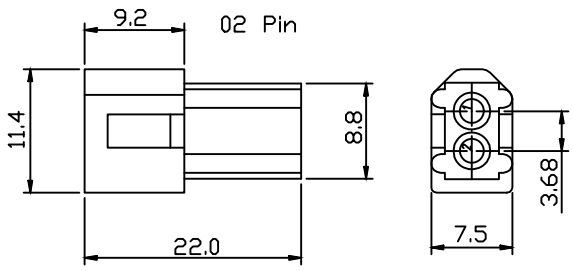

Order Information:
RHTAY3.68-1×XX-MH

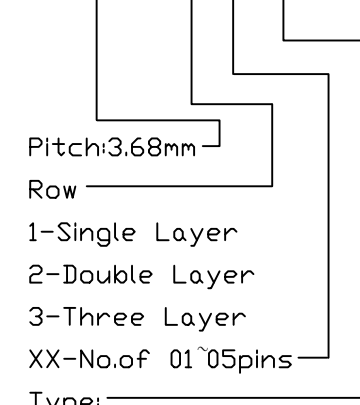

Pitch:3.68mm
Row
1-Single Layer
2-Double Layer
3-Three Layer
XX-No.of 01~05pins
Type:
FH/RFH-Female Hosing
MH/RMH-Male Hosing
FT-Female Terminal
MT-Male Terminal

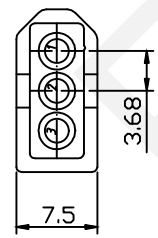
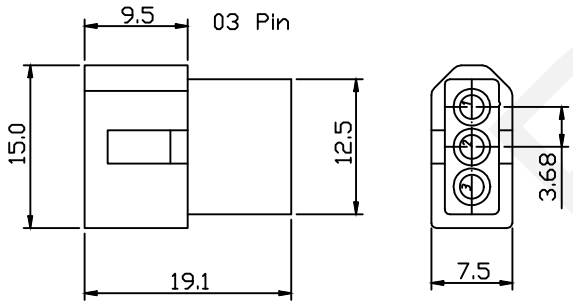

UNITS:mm	SHEET SIZE: A4				SCALE:----	DRWN BY PAN
0~3	3~18	18~50	50~120	CHK'D BY FENG	3.68mm Pitch 5500 5600 Wire To Wire Connector	
±0.12	±0.15	±0.3	±0.5	APPR BY ZHAN	THIRD ANGLE PROJECTION	RHTAY3.68-1×XX-MH



NINGBO RHT ELECTRONIC CO.,LTD

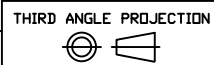

RHTAY3.68-1×XX-MH

RoHS Compliance

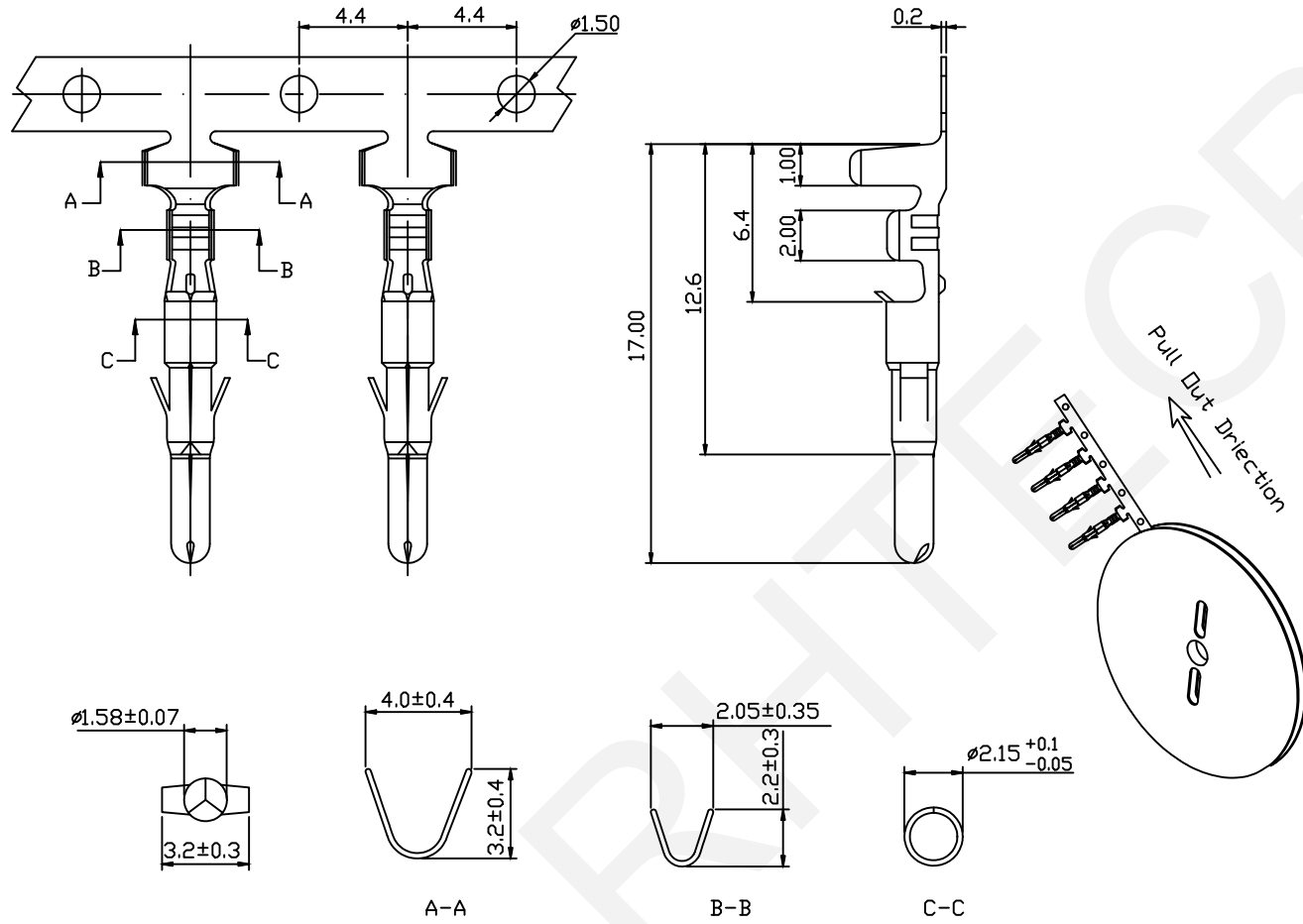

Material:
 Terminal: Brass
 Plating: Tin plated
 Applicable Wires: AWG #24~#18
 Thickness: 0.2mm
 Qty/Reel: 7000 PCS

Electrical Characteristics:
 Rated Current : 5.0V AC/DC
 Voltage Rating : 250V AC/DC
 Temperature Range: -25°C~+105°C
 Insulator Resistance: 1000MΩ/Min.
 Withstanding Voltage: 1500V AC/Minute
 Contact Resistance: 20MΩ/Max

Order Information:
RHTAY3.68-MT
 Pitch: 3.68mm
 Type: _____
 MT-Male Terminal

UNITS:mm	SHEET SIZE: A4	SCALE:---	DRWN BY PAN
0~3	3~18	18~50	50~120
±0.12	±0.15	±0.3	±0.5
CHK'D BY FENG		APPR BY ZHAN	

3.68mm Pitch 5500 5600 Wire To Wire Connector	
THIRD ANGLE PROJECTION 	RHTAY3.68-MT

NINGBO RHT ELECTRONIC CO.,LTD

RoHS Compliance

2x02 Pin

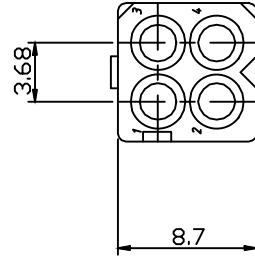
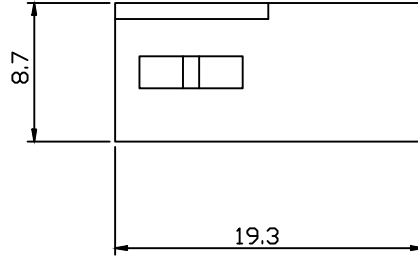

Material:

Housing: PA66,UL94V-2

Electrical Characteristics:

Rated Current : 5.0AMP

Temperature Range: -40°C~+105°C

Insulator Resistance: 1000MΩ/Min

Withstanding Voltage: 1500V AC/Minute

Order Information:

RHTAY3.68-2xXX-FH

Pitch:3.68mm

Row

1-Single Layer

2-Double Layer

3-Three Layer

02.03pins

Type:

FH/RFH-Female Hosing

MH/RMH-Male Hosing

FT-Female Terminal

MT-Male Terminal

2x03 Pin

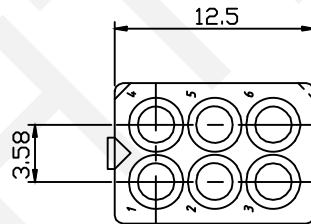
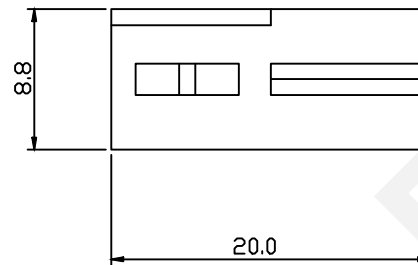

RHTECP NINGBO RHT ELECTRONIC CO.,LTD

UNITS:mm	SHEET SIZE: A4			SCALE:---
0~3	3~18	18~50	50~120	
±0.12	±0.15	±0.3	±0.5	

DRWN BY PAN
CHK'D BY FENG
APPR BY ZHAN

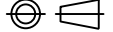
3.68mm Pitch 5500 5600
Wire To Wire Connector
THIRD ANGLE PROJECTION

RHTAY3.68-2xXX-FH

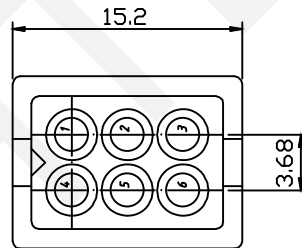
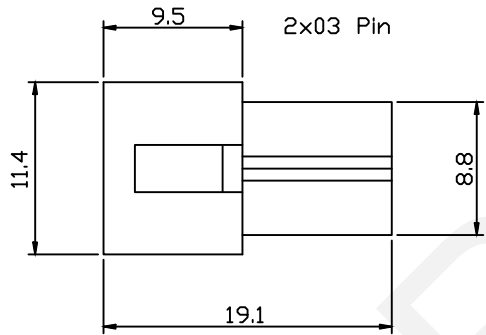
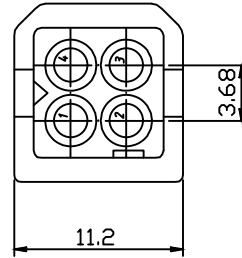
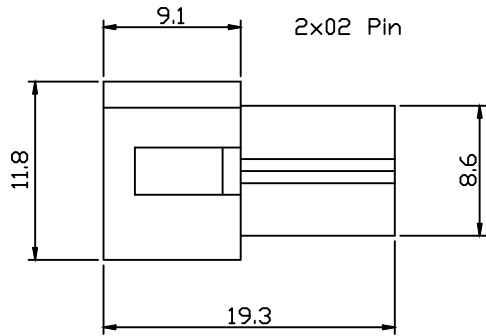
RoHS Compliance



Material:
Housing: PA66,UL94V-2

Electrical Characteristics:
Voltage Rating : 250V AC/DC
Rated Current : 5.0A AC/DC
Temperature Range: -40°C~+105°C
Insulator Resistance: 1000MΩ/Min
Withstanding Voltage: 1500V AC/Minute

Order Information:
RHTAY3.68-2xXX-MH

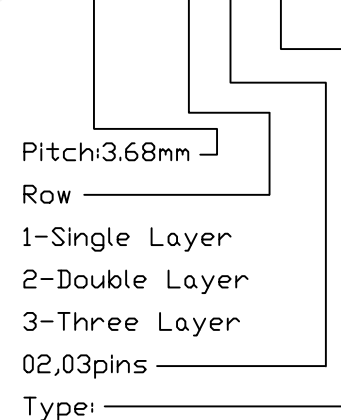

FH/RFH-Female Hosing
MH/RMH-Male Hosing
FT-Female Terminal
MT-Male Terminal

RHTECP NINGBO RHT ELECTRONIC CO.,LTD

UNITS:mm	SHEET SIZE: A4	SCALE:---	DRWN BY PAN
0~3	3~18	18~50	50~120
±0.12	±0.15	±0.3	±0.5

CHK'D BY FENG
APPR BY ZHAN

3.68mm Pitch 5500 5600
Wire To Wire Connector
THIRD ANGLE PROJECTION
 RHTAY3.68-2xXX-MH

RoHS Compliance

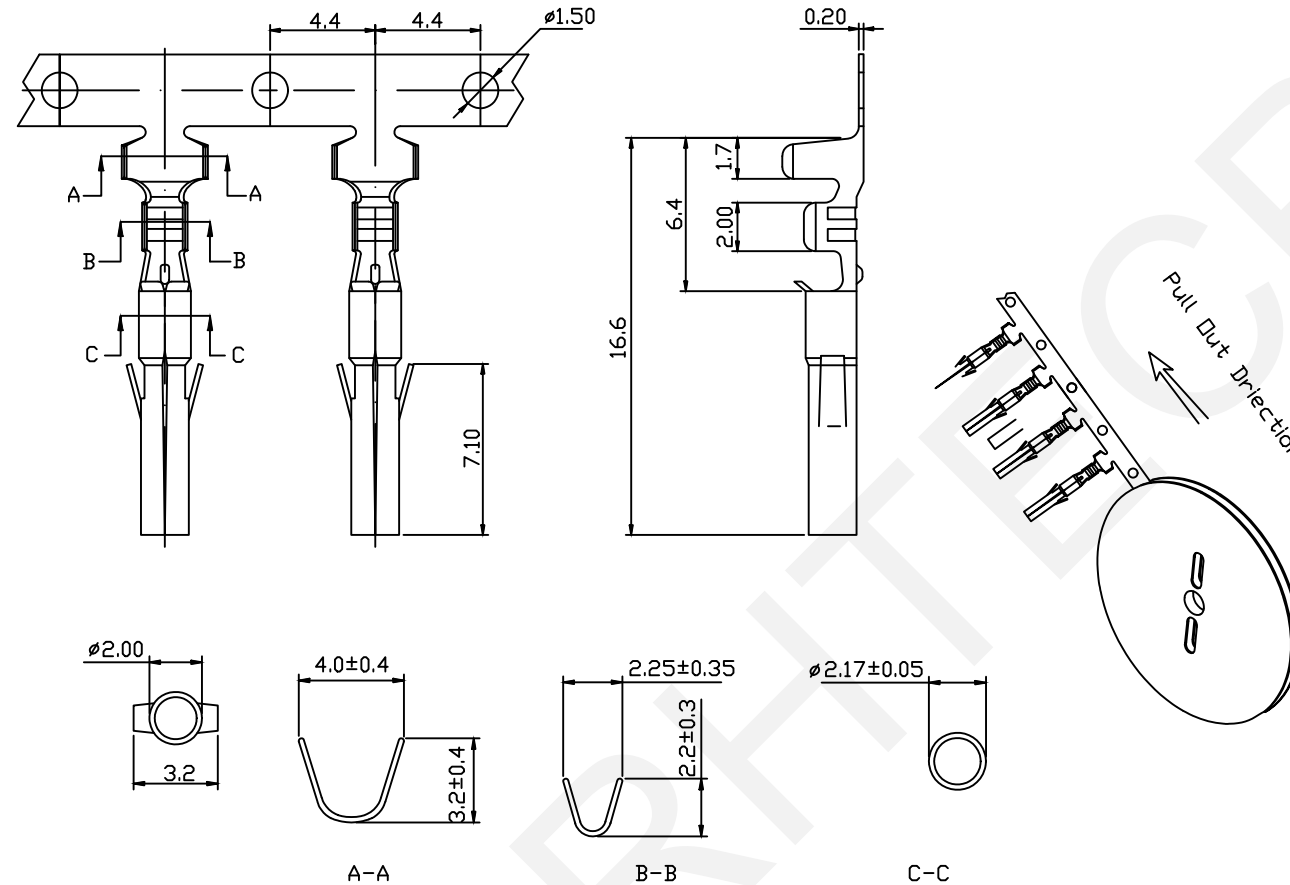

Material:
 Terminal: Brass
 Plating: Tin plated
 Applicable Wires: AWG #24~#18
 Thickness: 0.2mm
 Qty/Reel: 7000 PCS

Electrical Characteristics:
 Rated Current : 6.0V AC/DC
 Voltage Rating : 250V AC/DC
 Temperature Range: $-25^{\circ}\text{C} \sim +105^{\circ}\text{C}$
 Insulator Resistance: $1000\text{M}\Omega/\text{Min.}$
 Withstanding Voltage: 1500V AC/Minute
 Contact Resistance: $20\text{M}\Omega/\text{Max}$

Order Information:
 RHTAY3.68-FT

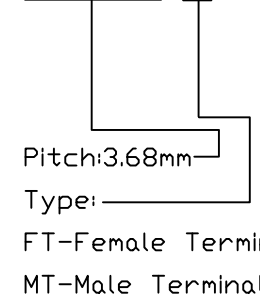

RHTECP NINGBO RHT ELECTRONIC CO.,LTD

UNITS:mm	SHEET SIZE: A4	SCALE:---	DRWN BY PAN
0~3	3~18	18~50	50~120
± 0.12	± 0.15	± 0.3	± 0.5
			CHK'D BY FENG
			APPR BY ZHAN

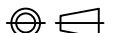
3.68mm Pitch 5500 5600
 Wire To Wire Connector
 THIRD ANGLE PROJECTION

 RHTAY3.68-FT

RoHS Compliance

Material:
Housing: PA66,UL94V-2

Electrical Characteristics:
Rated Current : 5.0AMP
Temperature Range: -40°C~+105°C
Insulator Resistance: 1000MΩ/Min
Withstanding Voltage: 1500V AC/Minute

Order Information:
RHTAY3.68-3xXX-FH

Pitch:3.68mm
Row
1-Single Layer
2-Double Layer
3-Three Layer
03,04,05pins
Type:
FH/RFH-Female Hosing
MH/RMH-Male Hosing
FT-Female Terminal
MT-Male Terminal

3x03 Pin

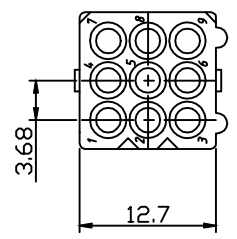
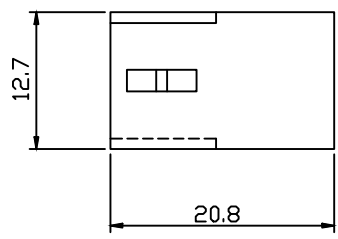

3x05 Pin

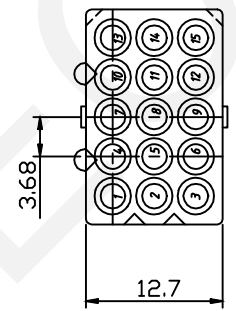
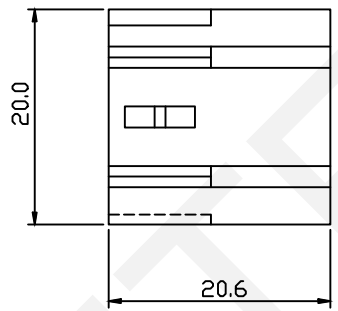

3x04 Pin

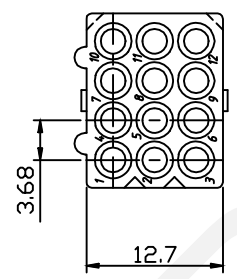
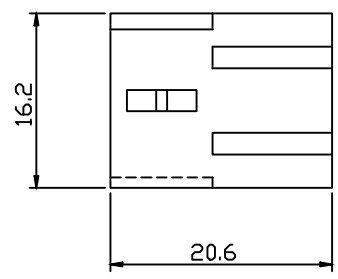

UNITS:mm	SHEET SIZE: A4				SCALE:---	DRWN BY PAN
0~3	3~18	18~50	50~120	CHK'D BY FENG	3.68mm Pitch 5500 5600 Wire To Wire Connector	
±0.12	±0.15	±0.3	±0.5	APPR BY ZHAN	THIRD ANGLE PROJECTION	RHTAY3.68-3xXX-FH

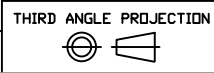

NINGBO RHT ELECTRONIC CO.,LTD

A
B
C
D
E
F
G

A
B
C
D
E
F
G

1 2 3 4 5 6 7 8 9

RoHS Compliance

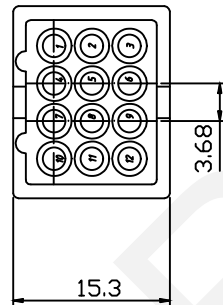
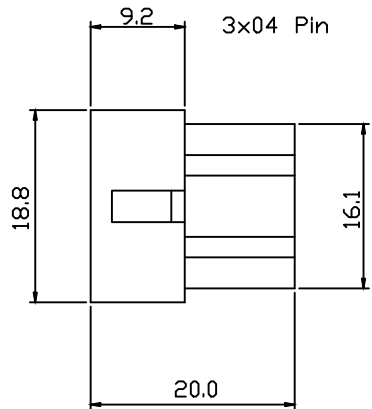
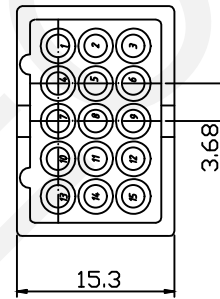
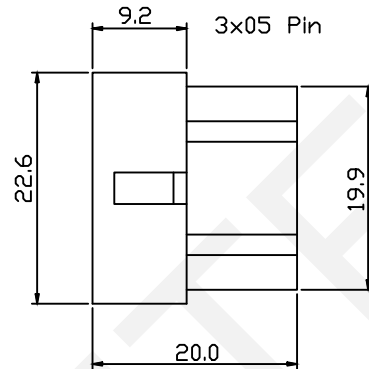
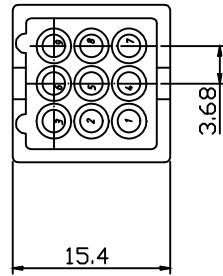
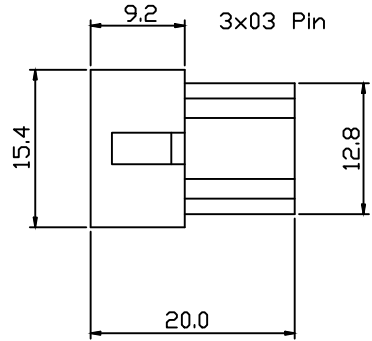

Material:

Housing: PA66,UL94V-2

Electrical Characteristics:

Voltage Rating : 250V AC/DC

Rated Current : 5.0A AC/DC

Temperature Range: -40°C~+105°C

Insulator Resistance: 1000MΩ/Min

Withstanding Voltage: 1500V AC/Minute

Order Information:

RHTAY3.68-3×XX-MH

Pitch:3.68mm

Row

1-Single Layer

2-Double Layer

3-Three Layer

03,04,05pins

Type:

FH/RFH-Female Hosing

MH/RMH-Male Hosing

FT-Female Terminal

MT-Male Terminal

 NINGBO RHT ELECTRONIC CO.,LTD

UNITS:mm

SHEET SIZE: A4

SCALE:---

DRWN BY PAN

3.68mm Pitch 5500 5600

Wire To Wire Connector

0~3

3~18

18~50

50~120

CHK'D BY FENG

THIRD ANGLE PROJECTION

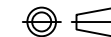

RHTAY3.68-3×XX-MH

±0.12

±0.15

±0.3

±0.5

APPR BY ZHAN

RoHS Compliance

Material:
Housing: PA66,UL94V-2

Electrical Characteristics:
Voltage Rating : 250V AC/DC
Rated Current : 5.0A AC/DC
Temperature Range: -40°C~+105°C
Insulator Resistance: 1000MΩ/Min
Withstanding Voltage: 1500V AC/Minute
Contact Resistance: 20MΩ/Max

Order Information:
RHTAY3.68-1xXX-RFH

Pitch:3.68mm
Row
1-Single Layer
2-Double Layer
3-Three Layer
XX-No.of 02~05pins
Type:
FH/RFH-Female Hosing
MH/RMH-Male Hosing
FT-Female Terminal
MT-Male Terminal

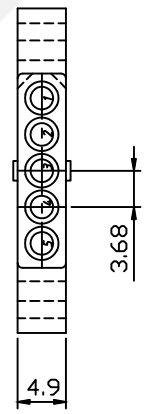
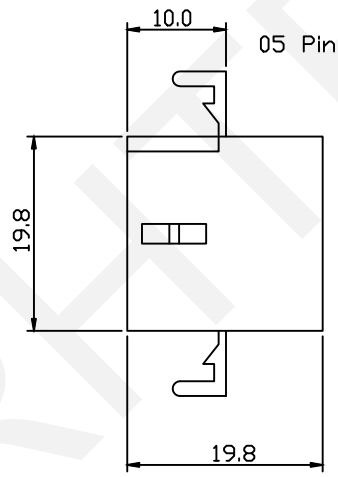
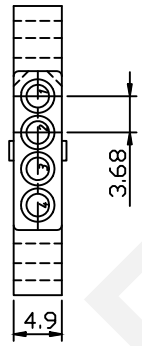
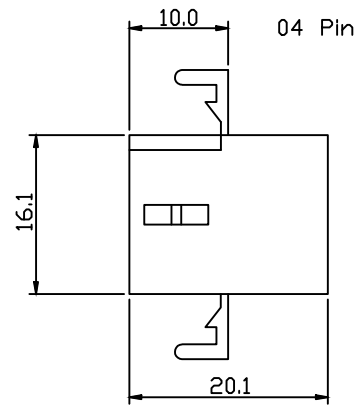
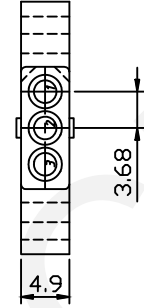
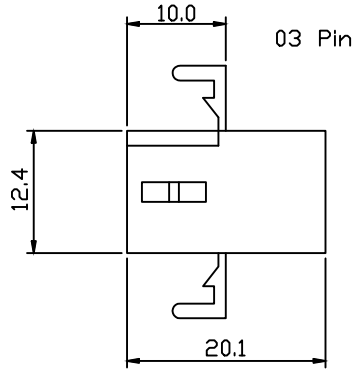
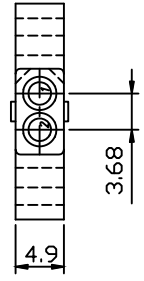
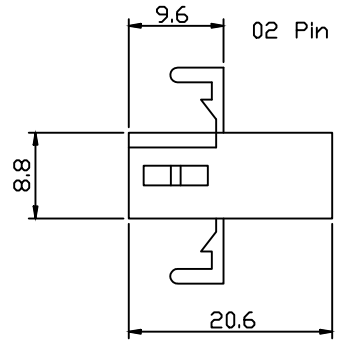

UNITS:mm	SHEET SIZE: A4				SCALE:---	DRWN BY PAN
0~3	3~18	18~50	50~120	CHK'D BY FENG	3.68mm Pitch 5500 5600 Wire To Wire Connector	
±0.12	±0.15	±0.3	±0.5	APPR BY ZHAN	THIRD ANGLE PROJECTION	RHTAY3.68-1xXX-RFH

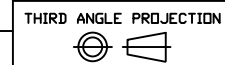

NINGBO RHT ELECTRONIC CO.,LTD

RoHS Compliance

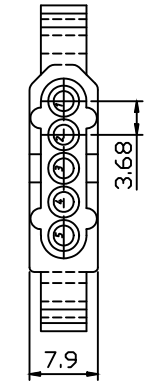
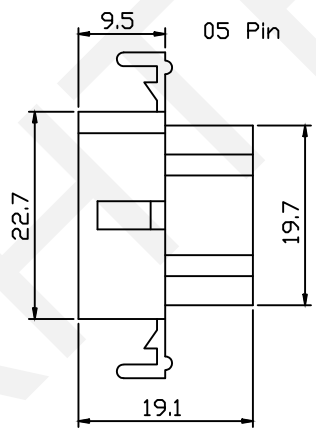
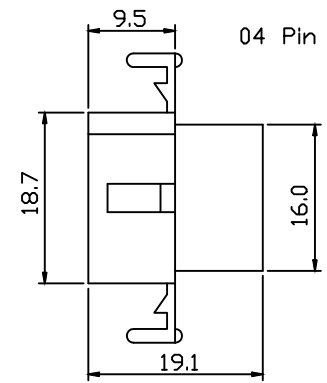
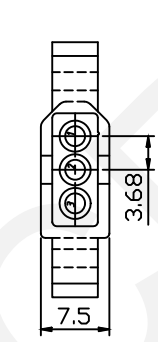
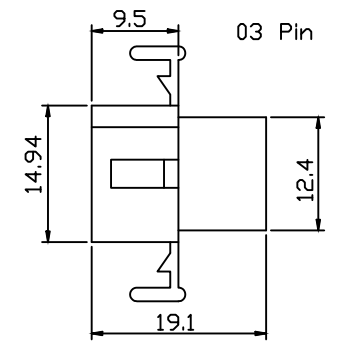
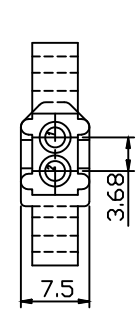
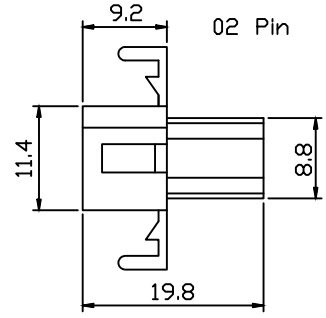

Material:
Housing: PA66,UL94V-2

Electrical Characteristics:
Voltage Rating : 250V AC/DC
Rated Current : 5.0A AC/DC
Temperature Range: -40°C~+105°C
Insulator Resistance: 1000MΩ/Min
Withstanding Voltage: 1500V AC/Minute
Contact Resistance: 20MΩ/Max

Order Information:
RHTAY3.68-1xXX-RMH

Pitch:3.68mm
Row
1-Single Layer
2-Double Layer
3-Three Layer
XX-No.of 02~05pins
Type:
FH/RFH-Female Hosing
MH/RMH-Male Hosing
FT-Female Terminal
MT-Male Terminal

RHTECP NINGBO RHT ELECTRONIC CO.,LTD

UNITS:mm	SHEET SIZE: A4			SCALE:----	DRWN BY PAN
0~3	3~18	18~50	50~120	CHK'D BY FENG	
±0.12	±0.15	±0.3	±0.5	APPR BY ZHAN	

3.68mm Pitch 5500 5600
Wire To Wire Connector
THIRD ANGLE PROJECTION
 RHTAY3.68-1xXX-RMH

RoHS Compliance

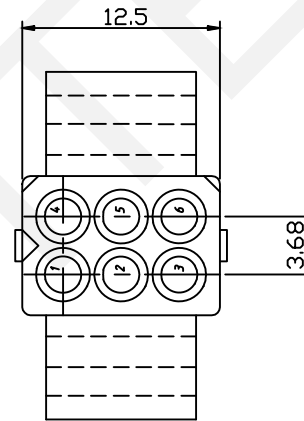
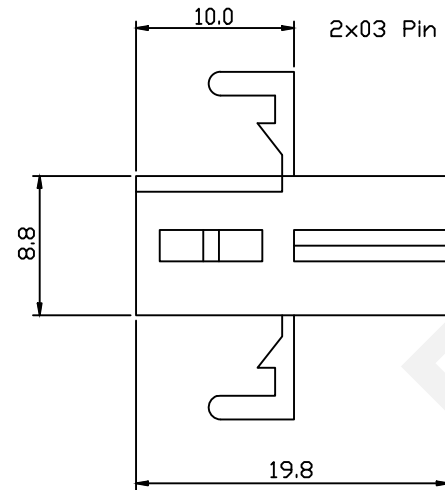
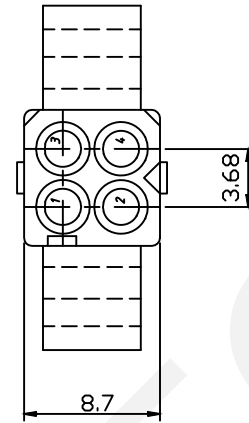
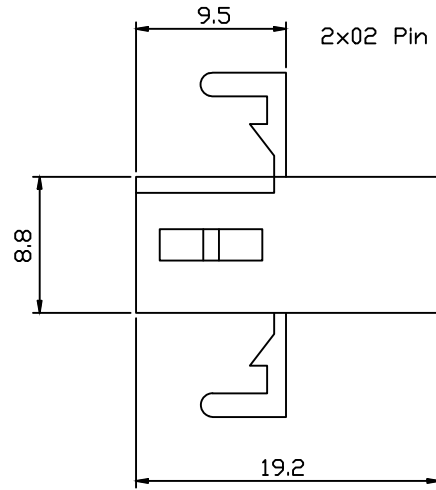

Material:
Housing: PA66,UL94V-2

Electrical Characteristics:
Voltage Rating : 250V AC/DC
Rated Current : 5.0A AC/DC
Temperature Range: -40°C~+105°C
Insulator Resistance: 1000MΩ/Min
Withstanding Voltage: 1500V AC/Minute
Contact Resistance: 20MΩ/Max

Order Information:
RHTAY3.68-2xXX-RFH

Pitch:3.68mm
Row
1-Single Layer
2-Double Layer
3-Three Layer
02,03 pins
Type:
FH/RFH-Female Hosing
MH/RMH-Male Hosing
FT-Female Terminal
MT-Male Terminal

RHTECP NINGBO RHT ELECTRONIC CO.,LTD

UNITS:mm	SHEET SIZE: A4	SCALE:---	DRWN BY PAN
0~3	3~18	18~50	50~120
±0.12	±0.15	±0.3	±0.5

CHK'D BY FENG
APPR BY ZHAN

3.68mm Pitch 5500 5600
Wire To Wire Connector
THIRD ANGLE PROJECTION
 RHTAY3.68-2xXX-RFH

RoHS Compliance

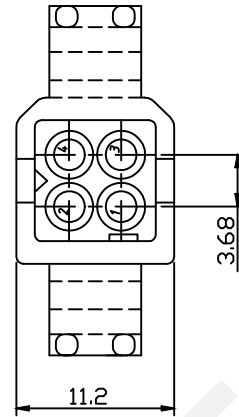
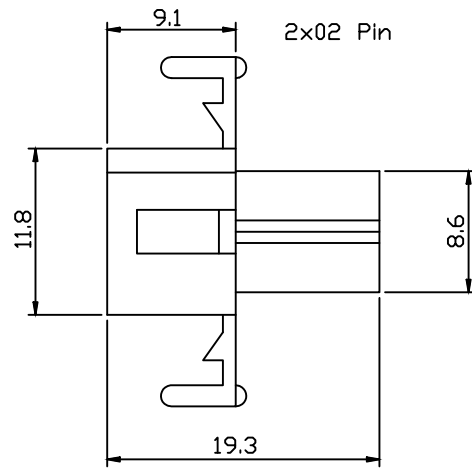

Material:

Housing: PA66,UL94V-2

Electrical Characteristics:

Voltage Rating : 250V AC/DC

Rated Current : 5.0A AC/DC

Temperature Range: -40°C~+105°C

Insulator Resistance: 1000MΩ/Min

Withstanding Voltage: 1500V AC/Minute

Contact Resistance: 20MΩ/Max

Order Information:

RHTAY3.68-2×XX-RMH

Pitch:3.68mm

Row

1-Single Layer

2-Double Layer

3-Three Layer

02,03 pins

Type:

FH/RFH-Female Hosing

MH/RMH-Male Hosing

FT-Female Terminal

MT-Male Terminal

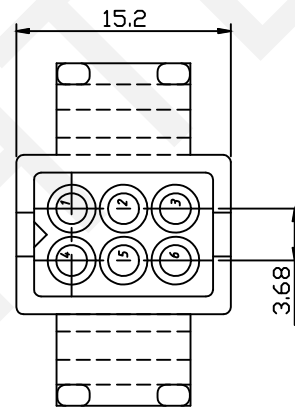
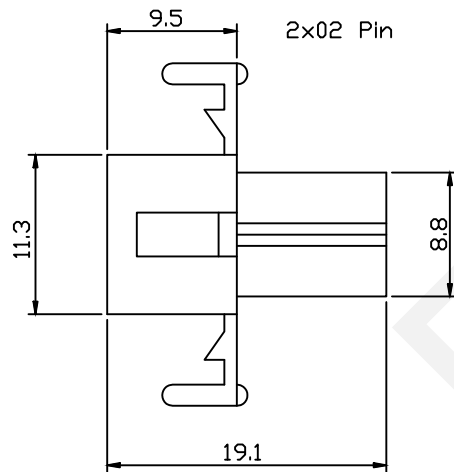

UNITS:mm	SHEET SIZE: A4	SCALE:---	DRWN BY PAN
0~3	3~18	18~50	50~120
±0.12	±0.15	±0.3	±0.5

CHK'D BY FENG
APPR BY ZHAN

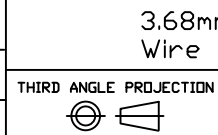

3.68mm Pitch 5500 5600
Wire To Wire Connector

RHTAY3.68-2×XX-RMH

RHTECP NINGBO RHT ELECTRONIC CO.,LTD

RoHS Compliance

Material:

Housing: PA66,UL94V-2

Electrical Characteristics:

Voltage Rating : 250V AC/DC

Rated Current : 5.0A AC/DC

Temperature Range: -40°C~+105°C

Insulator Resistance: 1000MΩ/Min

Withstanding Voltage: 1500V AC/Minute

Contact Resistance: 20MΩ/Max

Order Information:

RHTAY3.68-3×XX-RFH

Pitch:3.68mm

Row

1-Single Layer

2-Double Layer

3-Three Layer

03,04,05pins

Type:

FH/RFH-Female Hosing

MH/RMH-Male Hosing

FT-Female Terminal

MT-Male Terminal

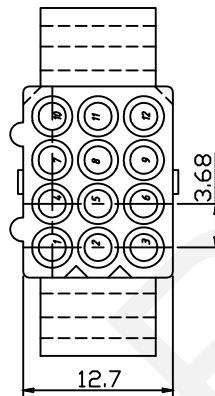
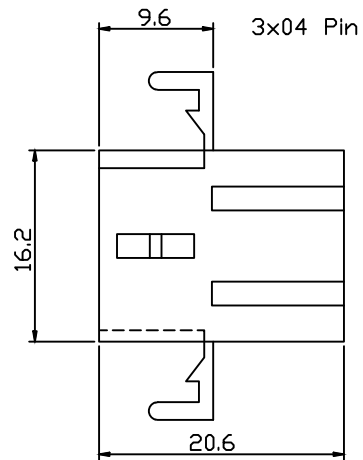
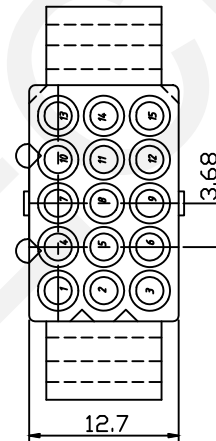
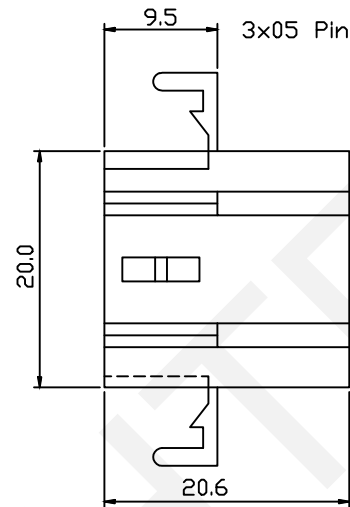
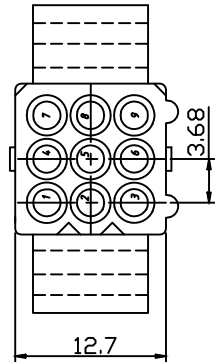
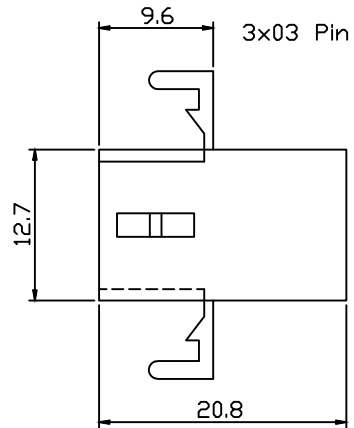

UNITS:mm	SHEET SIZE: A4				SCALE:---	DRWN BY PAN
0~3	3~18	18~50	50~120	CHK'D BY FENG	3.68mm Pitch 5500 5600 Wire To Wire Connector	
±0.12	±0.15	±0.3	±0.5	APPR BY ZHAN	THIRD ANGLE PROJECTION	RHTAY3.68-3×XX-RFH

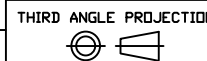

RHTECP NINGBO RHT ELECTRONIC CO.,LTD

RoHS Compliance

Material:
Housing: PA66,UL94V-2

Electrical Characteristics:
Voltage Rating : 250V AC/DC
Rated Current : 5.0A AC/DC
Temperature Range: -40°C~+105°C
Insulator Resistance: 1000MΩ/Min
Withstanding Voltage: 1500V AC/Minute
Contact Resistance: 20MΩ/Max

Order Information:
RHTAY3.68-3xXX-RMH

Pitch:3.68mm
Row
1-Single Layer
2-Double Layer
3-Three Layer
03,04,05pins
Type:
FH/RFH-Female Hosing
MH/RMH-Male Hosing
FT-Female Terminal
MT-Male Terminal

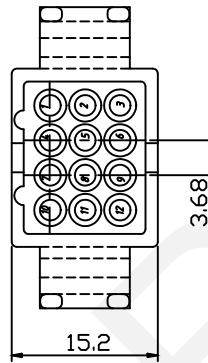
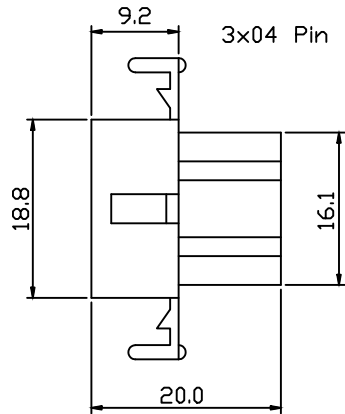
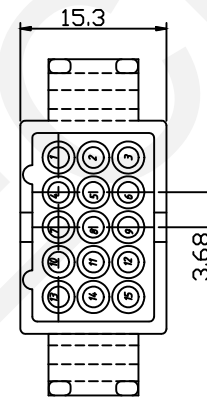
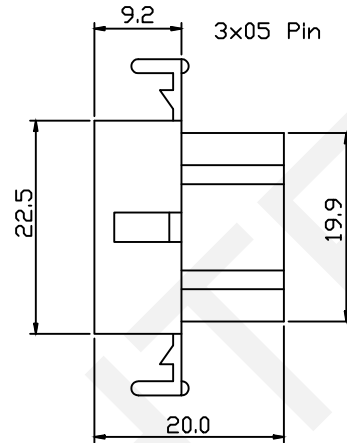
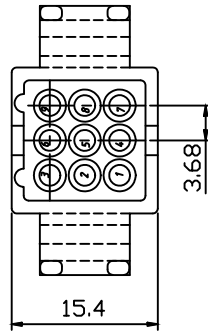
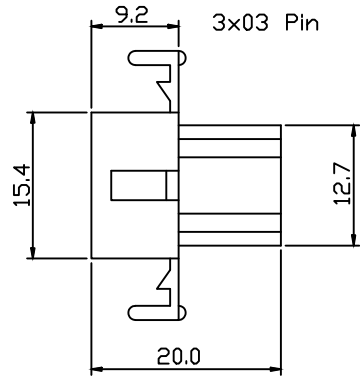

UNITS:mm	SHEET SIZE: A4				SCALE:---	DRWN BY PAN
0~3	3~18	18~50	50~120	CHK'D BY FENG	3.68mm Pitch 5500 5600 Wire To Wire Connector	
±0.12	±0.15	±0.3	±0.5	APPR BY ZHAN	THIRD ANGLE PROJECTION	RHTAY3.68-3xXX-RMH

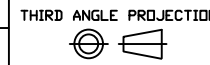

RHTECP NINGBO RHT ELECTRONIC CO.,LTD