

RoHS Compliance

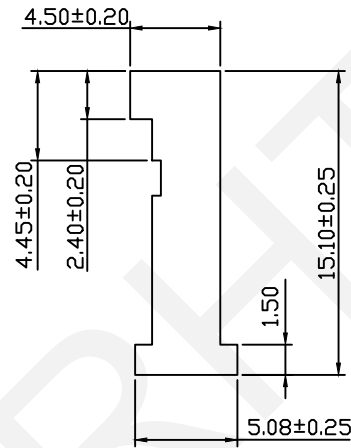
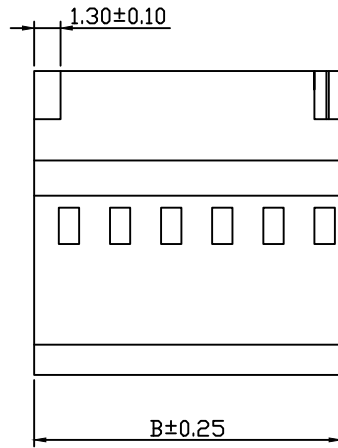
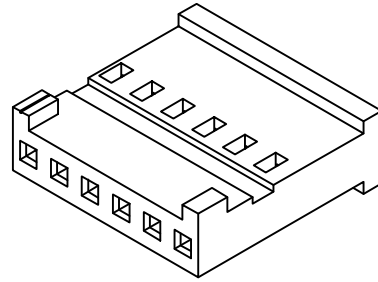
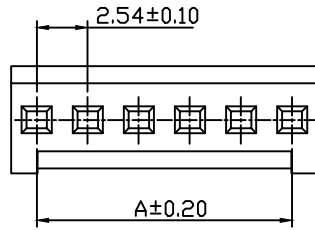

Pin	Dimension(mm)	
	A	B
02	2.54	5.08
03	5.08	7.62
04	7.62	10.16
05	10.16	12.70
06	12.70	15.24
07	15.24	17.78
08	17.78	20.32
09	20.32	22.86
10	22.86	25.40
12	27.94	30.48
15	35.56	38.10
18	43.18	45.72

Material:

Housing: PA66,UL94V-0,Black

Electrical Characteristics:

Rated Current : 3.0AMP

Voltage Rating: 250V AC,DC

Temperature Range:-45°C~+105°C

Insulation Resistance:1000MΩ

Withstand Voltage: 1000V AC/Minute

Contact Resistance: 20mΩ

Order Information:

RHTAYE-2.54-1-XX-H

Series No

Pitch:2.54mm

Row:

1-Single Layer

2-Double Layer

XX-No.of 02~18 Pins

Type:

H/HK-Housing T-Terminal

S-Straight Male Pin

R-Right Angle Male Pin

 NINGBO RHT ELECTRONIC CO.,LTD

UNITS:mm	SHEET SIZE: A4				SCALE:---	DRWN BY PAN
0~3	3~18	18~50	50~120	CHK'D BY FENG	2.54mm Pitch Wire To Board Connector	
±0.12	±0.15	±0.3	±0.5	APPR BY ZHAN	THIRD ANGLE PROJECTION	

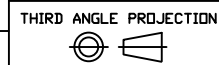

RHTAYE-2.54-1-XX-H

RoHS Compliance

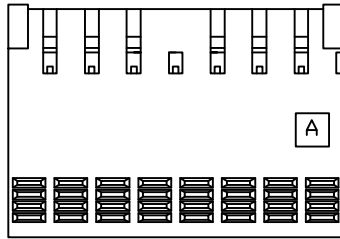
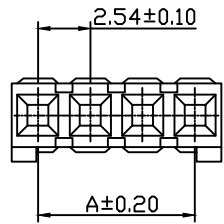

08P~36P

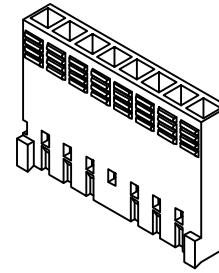

Material:

Housing: PBT,UL94V-0,Blue

Electrical Characteristics:

Rated Current : 3.0AMP

Voltage Rating: 250V AC,DC

Temperature Range:-45°C~+105°C

Insulation Resistance:1000MΩ

Withstand Voltage: 1000V AC/Minute

Contact Resistance: 20mΩ

Pin	Dimension(mm)		Pin	Dimension(mm)	
	A	B		A	B
02	2.54	5.08	19	45.72	48.26
03	5.08	7.62	20	48.26	50.80
04	7.62	10.16	21	50.80	53.34
05	10.16	12.70	22	53.34	55.88
06	12.70	15.24	23	55.88	58.42
07	15.24	17.78	24	58.42	60.96
08	17.78	20.32	25	60.96	63.50
09	20.32	22.86	26	63.50	66.04
10	22.86	25.40	27	66.04	68.58
11	25.40	27.94	28	68.58	71.12
12	27.94	30.48	29	71.12	73.66
13	30.48	33.02	30	73.66	76.20
14	33.02	35.56	31	76.20	78.74
15	35.56	38.10	32	78.74	81.28
16	38.10	40.64	33	81.28	83.82
17	40.64	43.18	34	83.82	86.36
18	43.18	45.72	35	86.36	88.90
			36	88.90	91.44

Order Information:

RHTAYE-2.54-1-XX-HK

Series No

Pitch:2.54mm

Row:

1-Single Layer

2-Double Layer

XX-No.of 02~36 Pins

Type:

H/HK-Housing T-Terminal

S-Straight Male Pin

R-Right Angle Male Pin

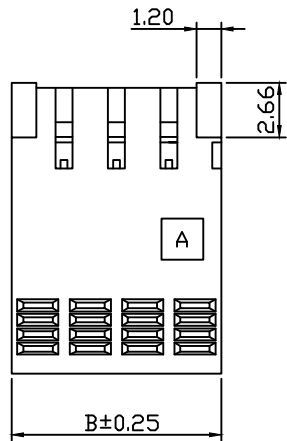

02P~07P

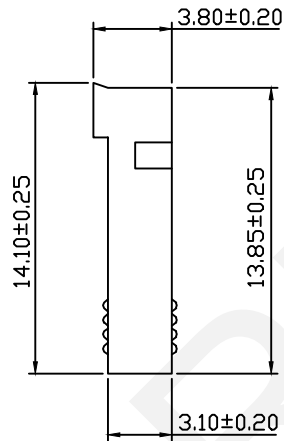

NINGBO RHT ELECTRONIC CO.,LTD

UNITS:mm

SHEET SIZE: A4

SCALE:---

DRWN BY PAN

2.54mm Pitch Wire To Board Connector

0~3

3~18

18~50

50~120

CHK'D BY FENG

THIRD ANGLE PROJECTION

±0.12

±0.15

±0.3

±0.5

APPR BY ZHAN

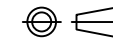

RHTAYE-2.54-1-XX-HK

1

2

3

4

5

6

7

8

9

RoHS Compliance

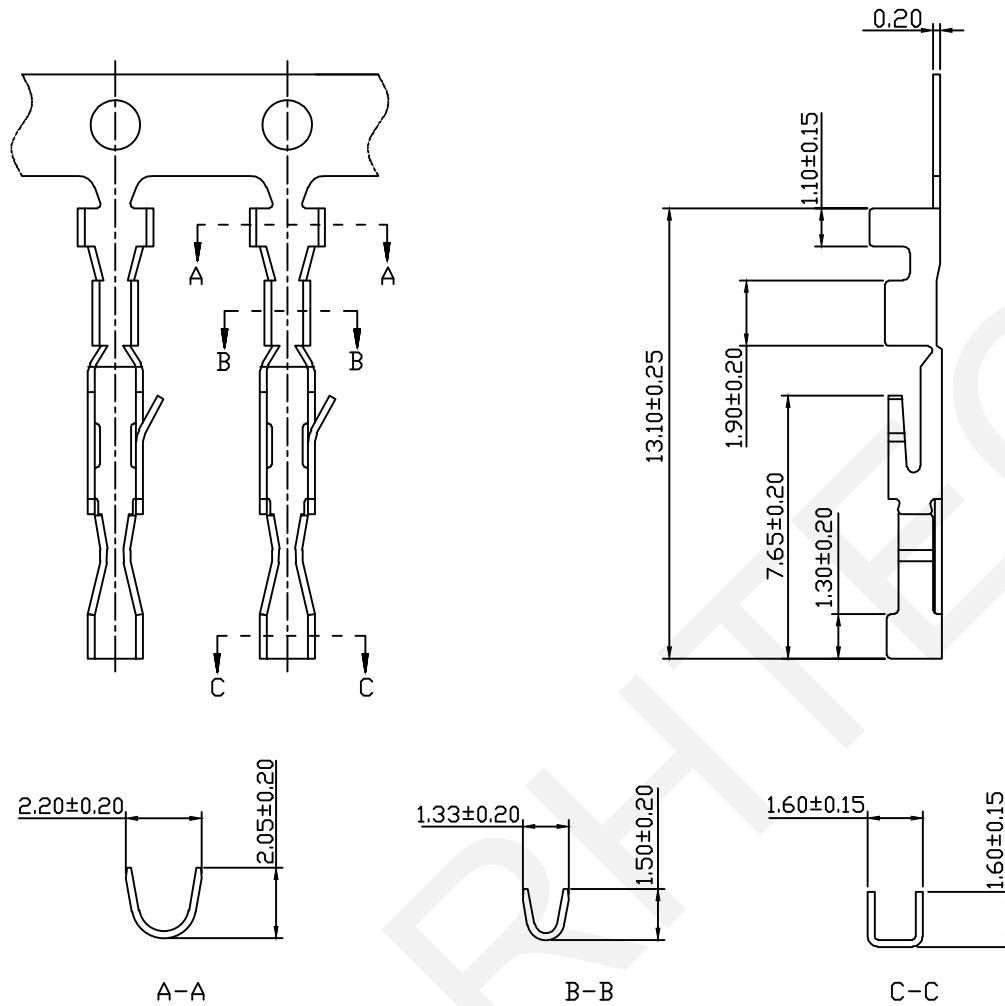

Material:  
 Terminal: Phosphor Bronze  
 Plating: Gold Plated Over Nickel  
 Applicable Wires: AWG #22~#28  
 Insulation  $\phi$ : 1.55mm  
 Qty/Reel: 20000 pcs

Electrical Characteristics:  
 Rated Current: 3.0AMP  
 Voltage Rating: 250V AC, DC  
 Temperature Range: -45°C ~ +105°C  
 Insulation Resistance: 1000M $\Omega$   
 Withstand Voltage: 1000V AC/Minute  
 Contact Resistance: 20m $\Omega$

Order Information:

RHTAYE-2.54-T

Series No

Pitch: 2.54mm

Type:

H/HK-Housing T-Terminal

S-Straight Male Pin

R-Right Angle Male Pin

 NINGBO RHT ELECTRONIC CO.,LTD

UNITS:mm	SHEET SIZE: A4			SCALE:---	DRWN BY PAN
0~3	3~18	18~50	50~120	CHK'D BY FENG	
±0.12	±0.15	±0.3	±0.5	APPR BY ZHAN	

2.54mm Pitch Wire To Board Connector

THIRD ANGLE PROJECTION



RHTAYE-2.54-T

RoHS Compliance

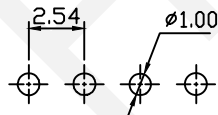
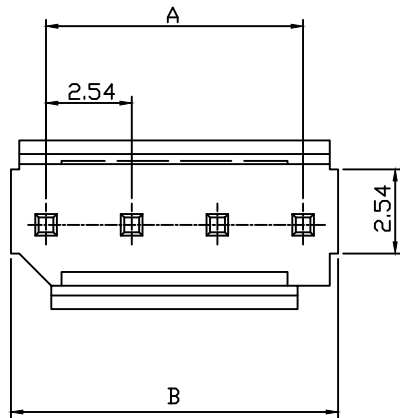
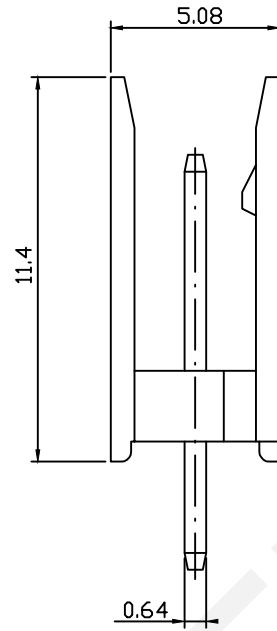
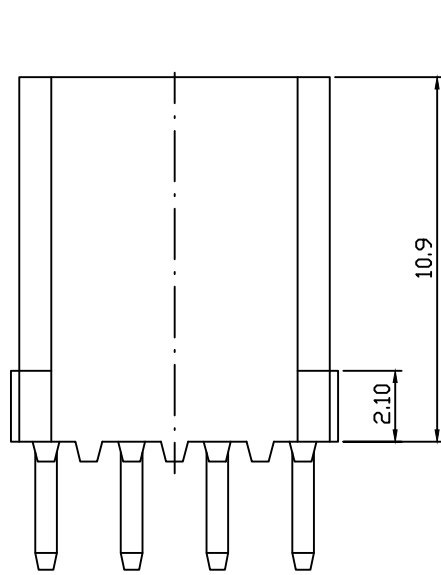

PCB LAYOUT

Pin	Dimension(mm)	
	A	B
02	2.54	5.08
03	5.08	7.62
04	7.62	10.16
05	10.16	12.70
06	12.70	15.24
07	15.24	17.78
08	17.78	22.86
10	22.86	27.94
12	27.94	35.56
15	35.56	40.64
17	40.64	43.18
18	43.18	45.72

Material:

Housing: PA46,UL94V-0,Blue

Pin:Brass, Tin plated

Electrical Characteristics:

Rated Current : 3.0AMP

Voltage Rating: 250V AC,DC

Temperature Range:-45°C~+105°C

Insulation Resistance:1000MΩ

Withstand Voltage: 1000V AC/Minute

Contact Resistance: 20mΩ

Order Information:

RHTAYE-2.54-1-XX-S

Series No

Pitch:2.54mm

Row:

1-Single Layer

2-Double Layer

XX-No.of 02~18 Pins

Type:

H/HK-Housing T-Terminal

S-Straight Male Pin

R-Right Angle Male Pin



NINGBO RHT ELECTRONIC CO.,LTD

UNITS:mm	SHEET SIZE: A4	SCALE:---	DRWN BY PAN
0~3	3~18	18~50	50~120
±0.12	±0.15	±0.3	±0.5

CHK'D BY FENG
APPR BY ZHAN

2.54mm Pitch Wire To Board Connector	
THIRD ANGLE PROJECTION	RHTAYE-2.54-1-XX-S

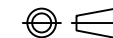

RoHS Compliance

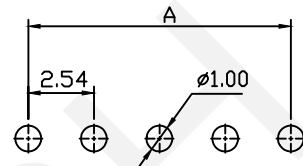
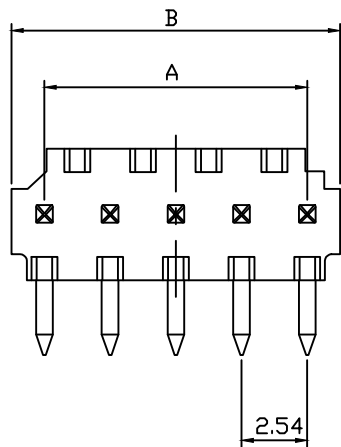
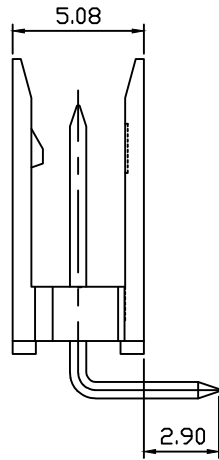
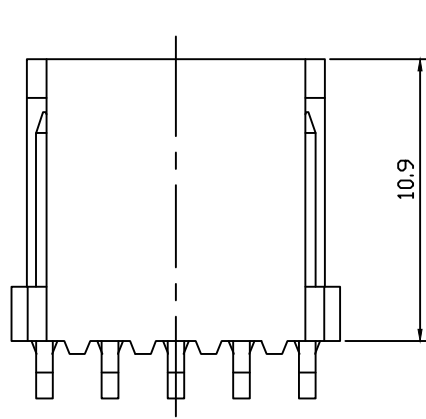

PCB LAYOUT

Pin	Dimension(mm)	
	A	B
02	2.54	5.08
03	5.08	7.62
04	7.62	10.16
05	10.16	12.70
06	12.70	15.24
07	15.24	17.78
08	17.78	22.86
10	22.86	27.94
12	27.94	35.56
15	35.56	40.64
17	40.64	43.18
18	43.18	45.72

Material:

Housing: PA46,UL94V-0,Blue

Pin:Brass, Tin plated

Electrical Characteristics:

Rated Current : 3.0AMP

Voltage Rating: 250V AC,DC

Temperature Range:-45°C~+105°C

Insulation Resistance:1000MΩ

Withstand Voltage: 1000V AC/Minute

Contact Resistance: 20mΩ

Order Information:

RHTAYE-2.54-1-XX-R

Series No

Pitch:2.54mm

Row:

1-Single Layer

2-Double Layer

XX-No.of 02~18 Pins

Type:

H/HK-Housing T-Terminal

S-Straight Male Pin

R-Right Angle Male Pin

**RHTECP** NINGBO RHT ELECTRONIC CO.,LTD

UNITS:mm	SHEET SIZE: A4			SCALE:---	DRWN BY PAN
0~3	3~18	18~50	50~120	CHK'D BY FENG	THIRD ANGLE PROJECTION 
±0.12	±0.15	±0.3	±0.5	APPR BY ZHAN	

2.54mm Pitch Wire To Board Connector

RHTAYE-2.54-1-XX-R

RoHS Compliance

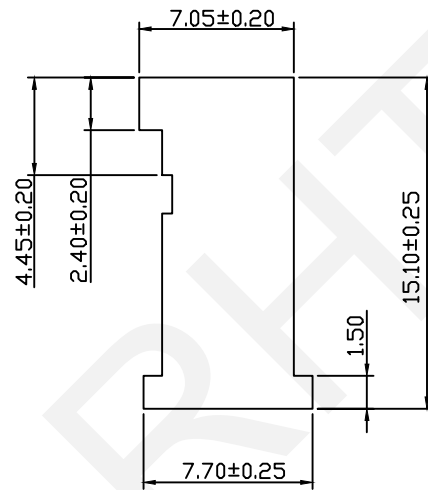
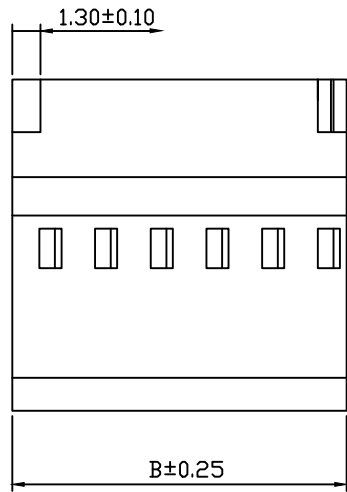
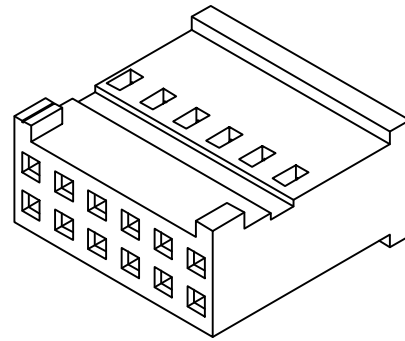
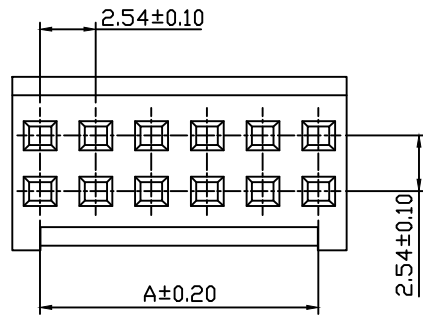

Pin	Dimension(mm)	
	A	B
2x02	2.54	5.08
2x03	5.08	7.62
2x04	7.62	10.16
2x05	10.16	12.70
2x06	12.70	15.24
2x07	15.24	17.78
2x08	17.78	20.32
2x09	20.32	22.86
2x10	22.86	25.40
2x15	35.56	38.10
2x18	43.18	45.72

Material:

Housing: PA66,UL94V-0,Black

Electrical Characteristics:

Rated Current : 3.0AMP

Voltage Rating: 250V AC,DC

Temperature Range:-45°C~+105°C

Insulation Resistance:1000MΩ

Withstand Voltage: 1000V AC/Minute

Contact Resistance: 20mΩ

Order Information:

RHTAYE-2.54-2-XX-H

Series No

Pitch:2.54mm

Row:

1-Single Layer

2-Double Layer

XX-No.of 02~18 Pins

Type:

H/HK-Housing T-Terminal

S-Straight Male Pin

R-Right Angle Male Pin

**RHTECP** NINGBO RHT ELECTRONIC CO.,LTD

UNITS:mm	SHEET SIZE: A4	SCALE:---	DRWN BY PAN
0~3	3~18	18~50	50~120
±0.12	±0.15	±0.3	±0.5
CHK'D BY FENG		APPR BY ZHAN	

2.54mm Pitch Wire To Board Connector

THIRD ANGLE PROJECTION

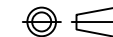

RHTAYE-2.54-2-XX-H

RoHS Compliance

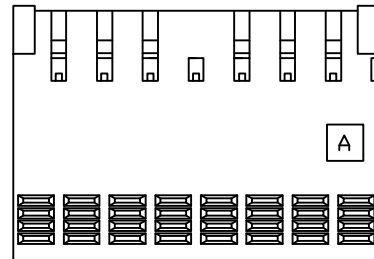
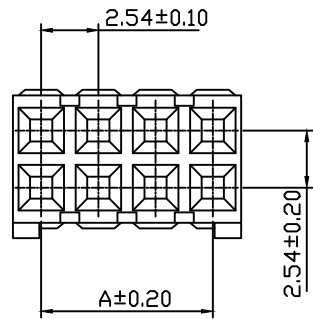

2x08P~2x 36P

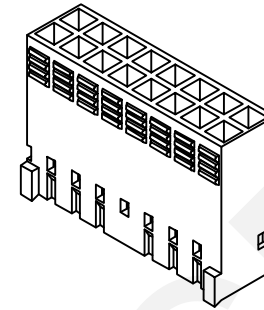

Material:

Housing: PBT,UL94V-0,Blue

Electrical Characteristics:

Rated Current : 3.0AMP

Voltage Rating: 250V AC,DC

Temperature Range:-45°C~+105°C

Insulation Resistance:1000MΩ

Withstand Voltage: 1000V AC/Minute

Contact Resistance: 20mΩ

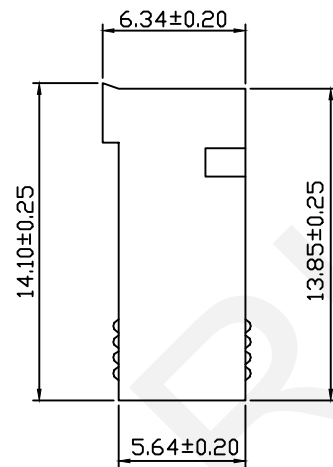
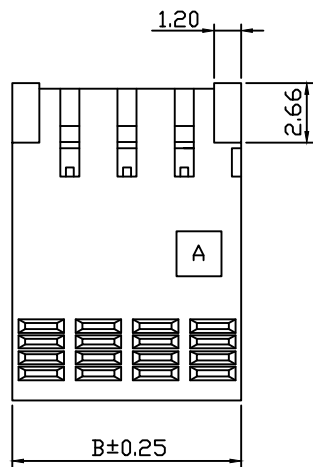

2x02P~2x07P

Pin	Dimension(mm)		Pin	Dimension(mm)	
	A	B		A	B
03	5.08	7.62	20	48.26	50.80
04	7.62	10.16	21	50.80	53.34
05	10.16	12.70	22	53.34	55.88
06	12.70	15.24	23	55.88	58.42
07	15.24	17.78	24	58.42	60.96
08	17.78	20.32	25	60.96	63.50
09	20.32	22.86	26	63.50	66.04
10	22.86	25.40	27	66.04	68.58
11	25.40	27.94	28	68.58	71.12
12	27.94	30.48	29	71.12	73.66
13	30.48	33.02	30	73.66	76.20
14	33.02	35.56	31	76.20	78.74
15	35.56	38.10	32	78.74	81.28
16	38.10	40.64	33	81.28	83.82
17	40.64	43.18	34	83.82	86.36
18	43.18	45.72	35	86.36	88.90
19	45.72	48.26	36	88.90	91.44

Order Information:

RHTAYE-2.54-2-XX-HK

Series No

Pitch:2.54mm

Row:

1-Single Layer

2-Double Layer

XX-No.of 06~72 Pins

Type:

H/HK-Housing T-Terminal

S-Straight Male Pin

R-Right Angle Male Pin

 NINGBO RHT ELECTRONIC CO.,LTD

UNITS:mm	SHEET SIZE: A4	SCALE:---	DRWN BY PAN
0~3	3~18	18~50	50~120
±0.12	±0.15	±0.3	±0.5
CHK'D BY FENG		APPR BY ZHAN	

2.54mm Pitch Wire To Board Connector

THIRD ANGLE PROJECTION

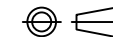

RHTAYE-2.54-2-XX-HK

RoHS Compliance

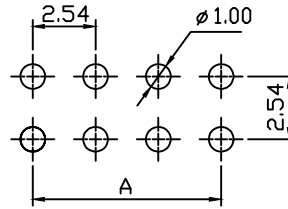
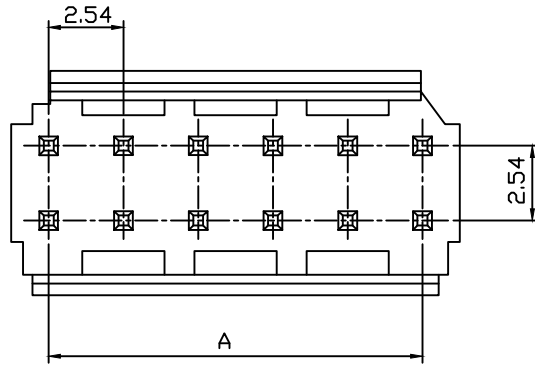

PCB LAYOUT

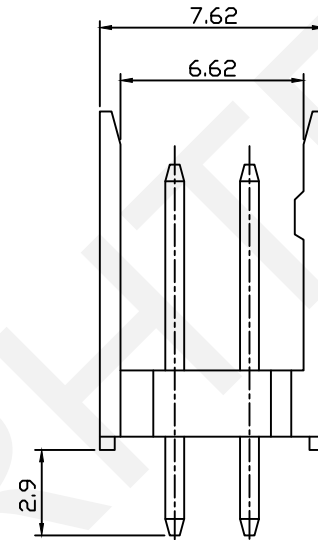
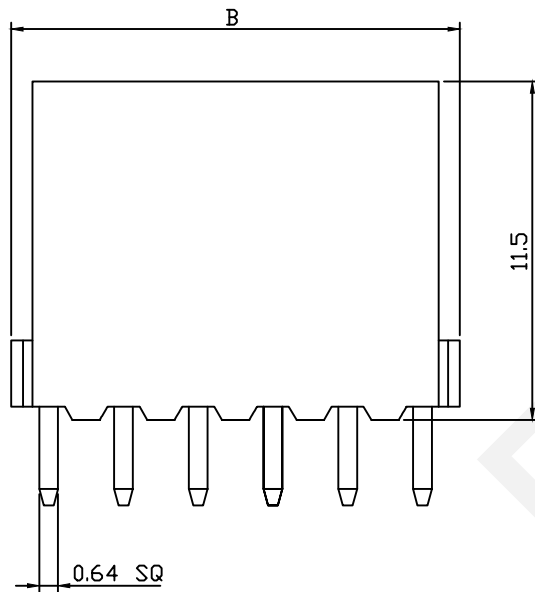

Material:

Housing: PA46,UL94V-0,Blue

Pin:Brass, Tin plated

Electrical Characteristics:

Rated Current : 3.0AMP

Voltage Rating: 250V AC,DC

Temperature Range:-45°C~+105°C

Insulation Resistance:1000MΩ

Withstand Voltage: 1000V AC/Minute

Contact Resistance: 20mΩ

Pin	Dimension(mm)	
	A	B
2x02	2.54	5.08
2x03	5.08	7.62
2x04	7.62	10.16
2x05	10.16	12.70
2x06	12.70	15.24
2x07	15.24	17.78
2x08	17.78	22.86
2x10	22.86	27.94
2x12	27.94	35.56
2x15	35.56	40.64
2x17	40.64	43.18
2x18	43.18	45.72

Order Information:

RHTAYE-2.54-2-XX-S

Series No: \_\_\_\_\_

Pitch:2.54mm

Row: \_\_\_\_\_

1-Single Layer

2-Double Layer

XX-No.of 04~36 Pins

Type: \_\_\_\_\_

H/HK-Housing T-Terminal

S-Straight Male Pin

R-Right Angle Male Pin

 NINGBO RHT ELECTRONIC CO.,LTD

UNITS:mm	SHEET SIZE: A4	SCALE:---	DRWN BY PAN
0~3	3~18	18~50	50~120
±0.12	±0.15	±0.3	±0.5
CHK'D BY FENG		APPR BY ZHAN	

2.54mm Pitch Wire To Board Connector

THIRD ANGLE PROJECTION

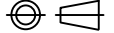

RHTAYE-2.54-2-XX-S



RoHS Compliance

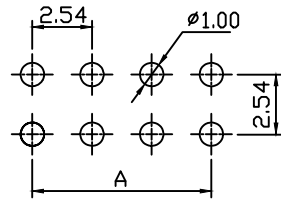
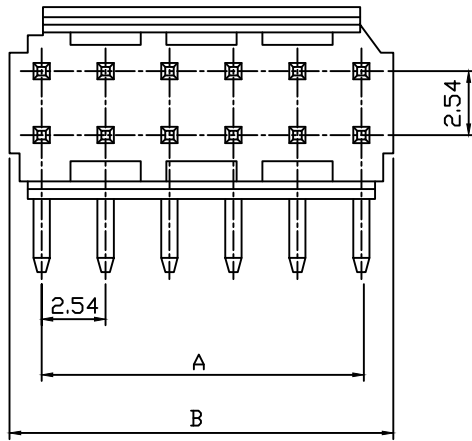

PCB LAYOUT

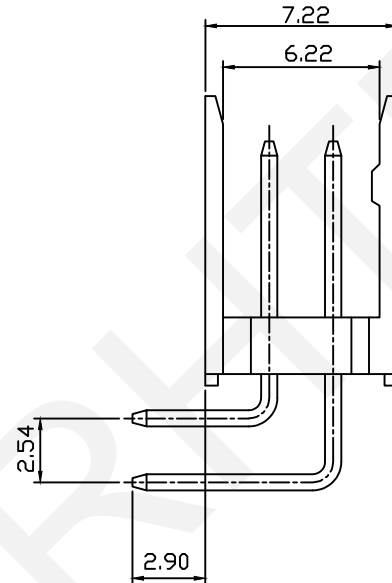
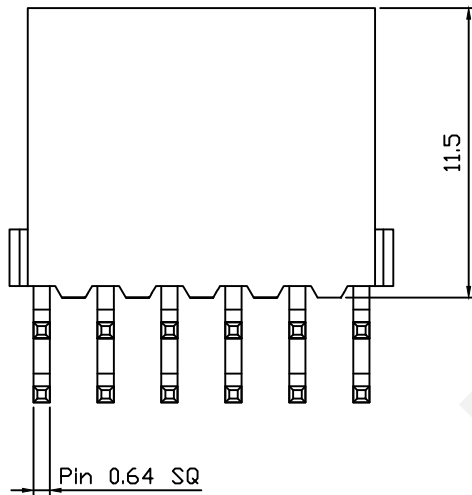

Pin	Dimension(mm)	
	A	B
2x02	2.54	5.08
2x03	5.08	7.62
2x04	7.62	10.16
2x05	10.16	12.70
2x06	12.70	15.24
2x07	15.24	17.78
2x08	17.78	22.86
2x10	22.86	27.94
2x12	27.94	35.56
2x15	35.56	40.64
2x17	40.64	43.18
2x18	43.18	45.72

Material:

Housing: PA46,UL94V-0,Blue

Pin:Brass, Tin Plated

Electrical Characteristics:

Rated Current : 3.0AMP

Voltage Rating: 250V AC,DC

Temperature Range:-45°C~+105°C

Insulation Resistance:1000MΩ

Withstand Voltage: 1000V AC/Minute

Contact Resistance: 20mΩ

Order Information:

RHTAYE-2.54-2-XX-R

Series No

Pitch:2.54mm

Row:

1-Single Layer

2-Double Layer

XX-No.of 04~36 Pins

Type:

H/HK-Housing T-Terminal

S-Straight Male Pin

R-Right Angle Male Pin

**RHTECP** NINGBO RHT ELECTRONIC CO.,LTD

UNITS:mm	SHEET SIZE: A4	SCALE:---	DRWN BY PAN
0~3	3~18	18~50	50~120
±0.12	±0.15	±0.3	±0.5

CHK'D BY FENG  
APPR BY ZHAN

2.54mm Pitch Wire To Board Connector  
THIRD ANGLE PROJECTION  
RHTAYE-2.54-2-XX-R