

RoHS Compliance

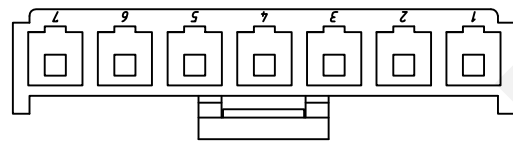
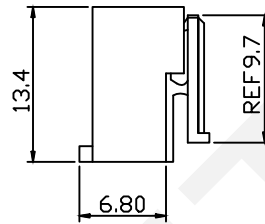
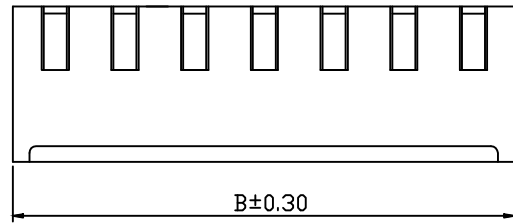
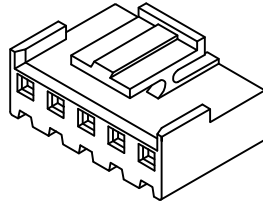
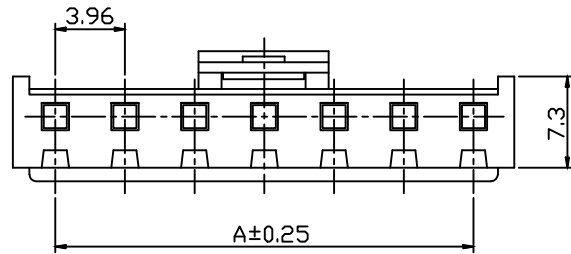

Material:

Housing: PA66,UL94V-0

Electrical Characteristics:

Rated Current : 7.0AMP

Voltage Rating : 250V AC,DC

Temperature Range: -25°C~+85°C

Insulator Resistance: 1000MΩ/Min.

Withstanding Voltage: 1500V AC/Minute

Contact Resistance: 20MΩ/Max

Pins	Dimension(mm)	
	A	B
02	3.96	7.92
03	7.92	11.88
04	11.88	15.84
05	15.84	19.80
06	19.80	23.76
07	23.76	27.72
08	27.72	31.68
09	31.68	35.64
10	35.64	39.60
11	39.60	43.56
12	43.56	47.52
13	47.52	51.48
14	51.48	55.44
15	55.44	59.40
16	59.40	63.36

Order Information:

RHTAY3.96A-XX-H

Pitch:3.96mm

XX-No.of 02~16Pins

Type:

H-Hosing T-Terminal

S-Straight Male Pin

R-Right Angle Male Pin

VM-Vertical SMT Pin

RM-Horizontal SMT Pin

 NINGBO RHT ELECTRONIC CO.,LTD

UNITS:mm SHEET SIZE: A4 SCALE:--- DRWN BY PAN

0~3 3~18 18~50 50~120 CHK'D BY FENG

±0.12 ±0.15 ±0.3 ±0.5 APPR BY ZHAN

3.96mm VH Type  
Wire To Board Connector

THIRD ANGLE PROJECTION

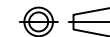

RHTAY3.96A-XX-H

RoHS Compliance

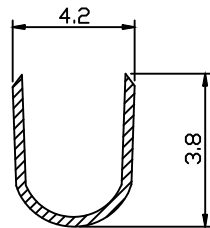
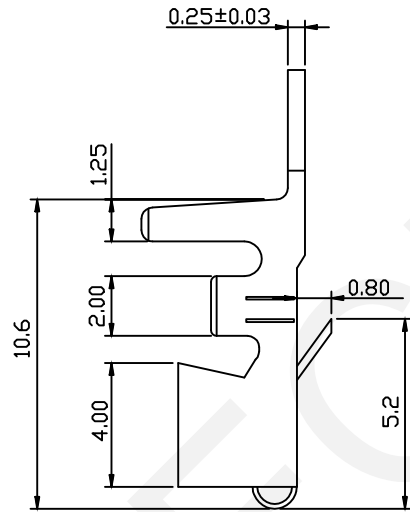
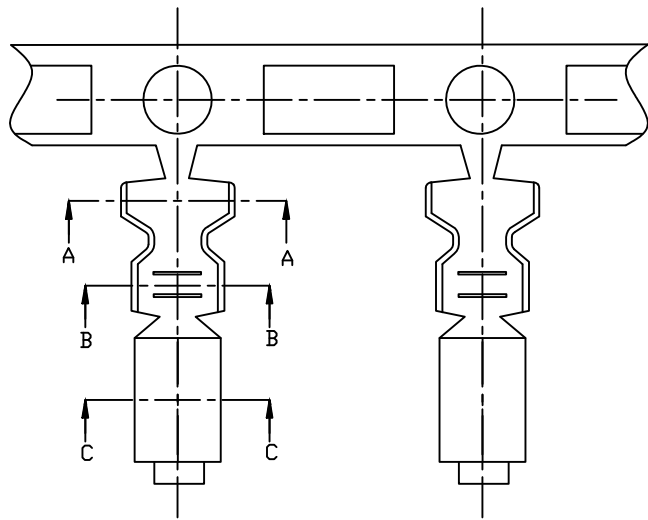

A-A

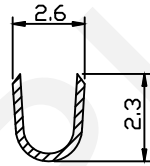

B-B

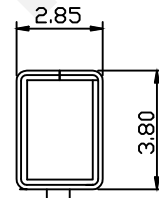

C-C

Material:

Terminal: Brass Or Phosphor Bronze

Plating: Tin Plated Over Nickel

Applicable Wires: AWG #22~#18

Insulation O.D.: 2.8mm

Qty/Reel: 3000 PCS

Electrical Characteristics:

Rated Current : 7.0AMP

Voltage Rating : 250V AC,DC

Temperature Range: -25°C~+85°C

Insulator Resistance: 1000MΩ/Min.

Withstanding Voltage: 1500V AC/Minute

Contact Resistance: 20MΩ/Max

Order Information:

RHTAY3.96A-T

Pitch: 3.96mm

Type:

H-Hosing T-Terminal

S-Straight Male Pin

R-Right Angle Male Pin

VM-Vertical SMT Pin

RM-Horizontal SMT Pin

**RHTECP** NINGBO RHT ELECTRONIC CO.,LTD

UNITS:mm	SHEET SIZE: A4	SCALE:---	DRWN BY PAN
0~3	3~18	18~50	50~120
±0.12	±0.15	±0.3	±0.5

CHK'D BY FENG  
APPR BY ZHAN

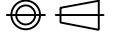
3.96mm VH Type  
Wire To Board Connector  
THIRD ANGLE PROJECTION  
  
RHTAY3.96A-T

RoHS Compliance

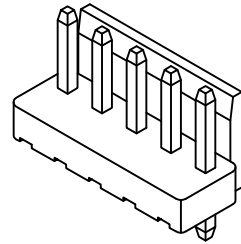
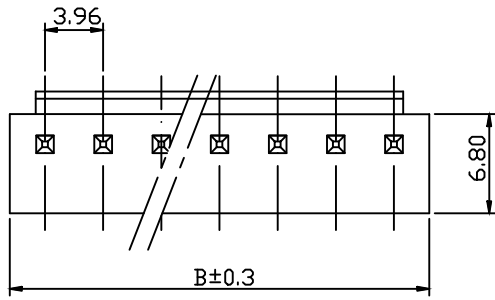

Material:  
 Housing: PA66,UL94V-0  
 Contact:Brass  
 Plating: Tin Plated Over Nickel

Pins	Dimension(mm)	
	A	B
02	3.96	7.92
03	7.92	11.88
04	11.88	15.84
05	15.84	19.80
06	19.80	23.76
07	23.76	27.72
08	27.72	31.68
09	31.68	35.64
10	35.64	39.60
11	39.60	43.56
12	43.56	47.52
13	47.52	51.48
14	51.48	55.44
15	55.44	59.40
16	59.40	63.36

Electrical Characteristics:  
 Rated Current : 7.0AMP  
 Voltage Rating : 250V AC,DC  
 Temperature Range: -25°C~+85°C  
 Insulator Resistance: 1000MΩ/Min.  
 Withstanding Voltage: 1500V AC/Minute  
 Contact Resistance: 20MΩ/Max

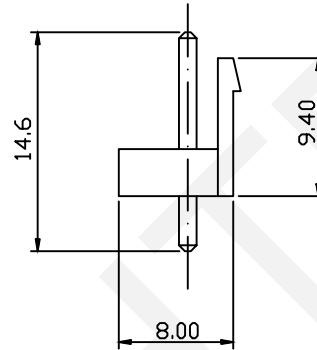
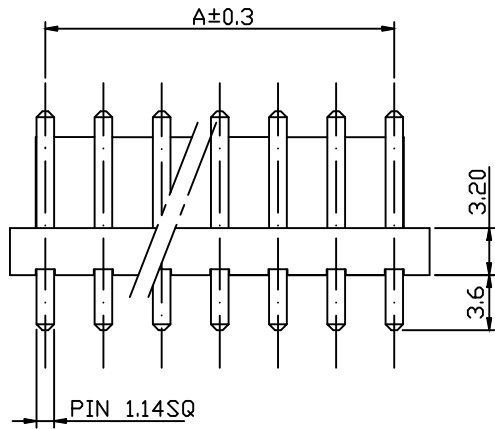

Order Information:  
 RHTAY3.96A-XX-S

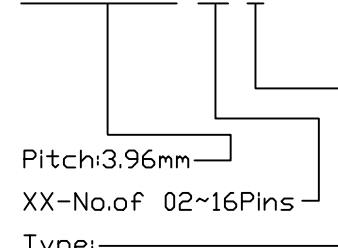

Type:  
 H-Hosing T-Terminal  
 S-Straight Male Pin  
 R-Right Angle Male Pin  
 VM-Vertical SMT Pin  
 RM-Horizontal SMT Pin

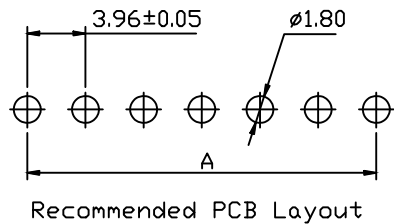

UNITS:mm	SHEET SIZE: A4			SCALE:---	DRWN BY PAN
0~3	3~18	18~50	50~120	CHK'D BY FENG	
±0.12	±0.15	±0.3	±0.5	APPR BY ZHAN	

3.96mm VH Type  
 Wire To Board Connector

THIRD ANGLE PROJECTION

RHTAY3.96A-XX-S

RoHS Compliance

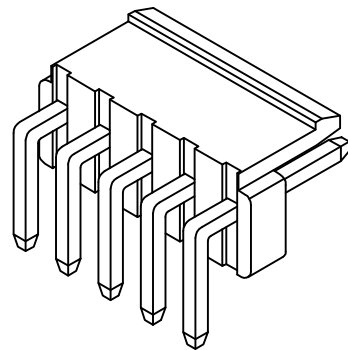
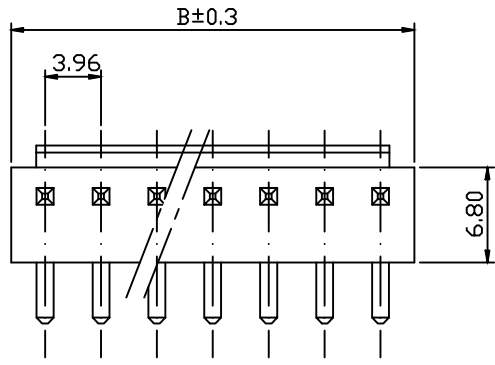

Material:  
 Housing: PA66,UL94V-0  
 Contact:Brass  
 Plating: Tin Plated Over Nickel

Pins	Dimension(mm)	
	A	B
02	3.96	7.92
03	7.92	11.88
04	11.88	15.84
05	15.84	19.80
06	19.80	23.76
07	23.76	27.72
08	27.72	31.68
09	31.68	35.64
10	35.64	39.60
11	39.60	43.56
12	43.56	47.52
13	47.52	51.48
14	51.48	55.44
15	55.44	59.40
16	59.40	63.36

Electrical Characteristics:  
 Rated Current : 7.0AMP  
 Voltage Rating : 250V AC,DC  
 Temperature Range: -25°C~+85°C  
 Insulator Resistance: 1000MΩ/Min.  
 Withstanding Voltage: 1500V AC/Minute  
 Contact Resistance: 20MΩ/Max

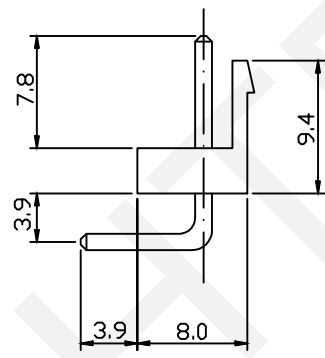
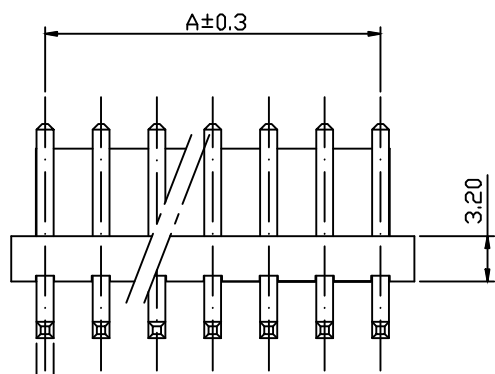

Order Information:

RHTAY3.96A-XX-R

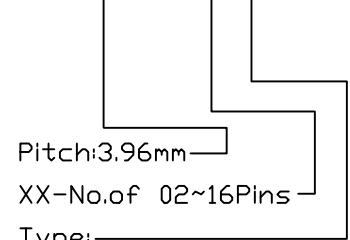

Pitch:3.96mm

XX-No.of 02~16Pins

Type:

- H-Hosing T-Terminal
- S-Straight Male Pin
- R-Right Angle Male Pin
- VM-Vertical SMT Pin
- RM-Horizontal SMT Pin

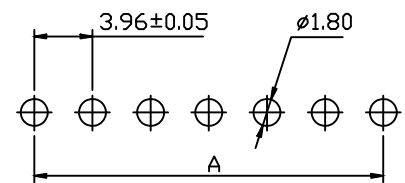

Recommended PCB Layout



NINGBO RHT ELECTRONIC CO.,LTD

UNITS:mm	SHEET SIZE: A4				SCALE:---	DRWN BY PAN
0~3	3~18	18~50	50~120	CHK'D BY FENG	THIRD ANGLE PROJECTION	
±0.12	±0.15	±0.3	±0.5	APPR BY ZHAN	RHTAY3.96A-XX-R	

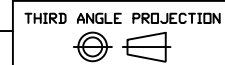

RHTAY3.96A-XX-R

RoHS Compliance

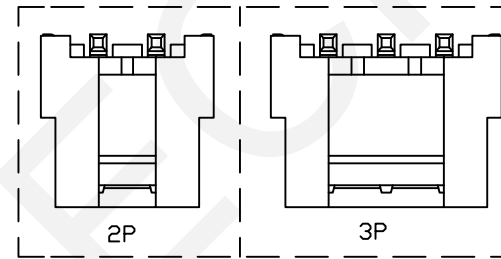
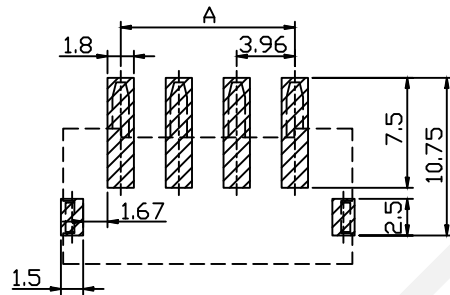
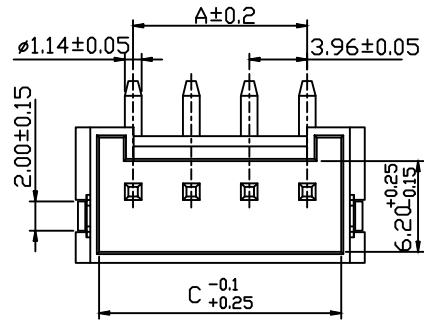
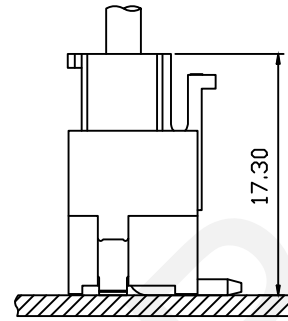
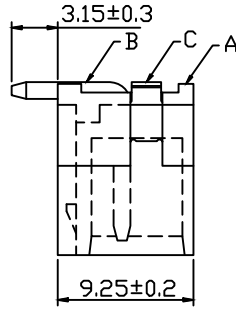
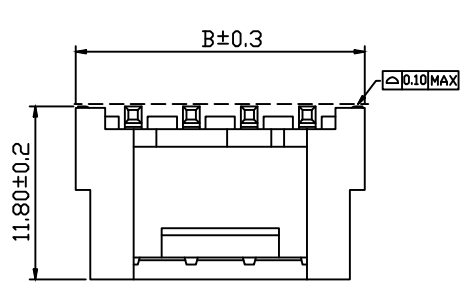

Material:  
 Insulator: PA6T UL94 V-0, Beige  
 Contacts: Brass, Tin Plated  
 Solder Tab: Brass, Tin Plated

Electrical Specification:  
 Poles: 02 to 16  
 Contact Resistance:  $\leq 20m\Omega$   
 Insulation Resistance:  $\geq 1000M\Omega$   
 Rated Voltage: 250V AC DC  
 Rated Current: 7.0A AC DC  
 Withstand Voltage: 1500V AC/Minute  
 Temperature Range:  $-25^{\circ}C \sim +105^{\circ}C$

Order Information:  
RHTAY3.96A-XX-VM

Pitch: 3.96mm  
 XX-No. of 02~16 Pins  
 Type: \_\_\_\_\_  
 H-Hosing T-Terminal  
 S-Straight Male Pin  
 R-Right Angle Male Pin  
 VM-Vertical SMT Pin  
 RM-Horizontal SMT Pin

Circuit	Dimension(mm)			Circuit	Dimension(mm)		
	A	B	C		A	B	C
02	3.96	11.80	8.60	10	35.64	43.48	40.28
03	7.92	15.76	12.56	11	39.60	47.44	44.24
04	11.88	19.72	16.52	12	43.56	51.40	48.20
05	15.84	23.68	20.48	13	47.52	55.36	52.16
06	19.80	27.64	24.44	14	51.48	59.32	56.12
07	23.76	31.60	28.40	15	55.44	63.28	60.08
08	27.72	35.56	32.36	16	59.40	67.24	64.04
09	31.68	39.52	36.32				

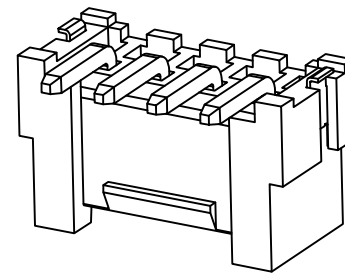

**RHTECP** NINGBO RHT ELECTRONIC CO.,LTD

UNITS:mm SHEET SIZE: A4 SCALE: ---  
 DRWN BY PAN  
 0~3 3~18 18~50 50~120  
 CHK'D BY FENG  
 ±0.12 ±0.15 ±0.3 ±0.5  
 APPR BY ZHAN

3.96mm VH Type  
 Wire To Board Connector  
 THIRD ANGLE PROJECTION  
 RHTAY3.96A-XX-VM

RoHS Compliance

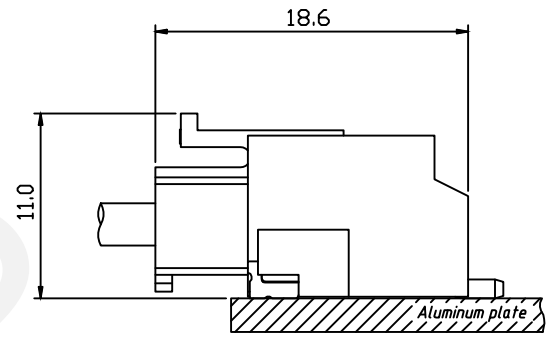
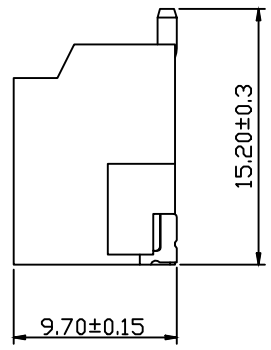
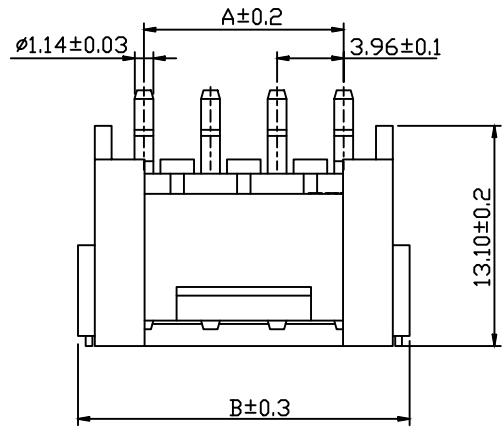

Assembly Layout

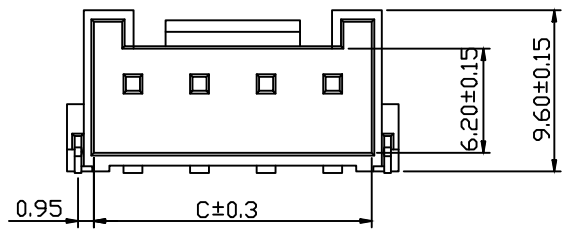
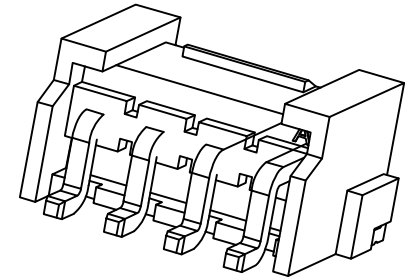

Material:  
 Insulator: PA6T UL94V-0, Beige  
 Contacts: Brass, Tin Plated  
 Solder Tab: Brass, Tin Plated

Electrical Specification:  
 Poles: 02 to 16  
 Contact Resistance:  $\leq 20m\Omega$   
 Insulation Resistance:  $\geq 1000M\Omega$   
 Rated Voltage: 250V AC DC  
 Rated Current: 7.0A AC DC  
 Withstand Voltage: 1500V AC/Minute  
 Temperature Range:  $-25^{\circ}C \sim +105^{\circ}C$

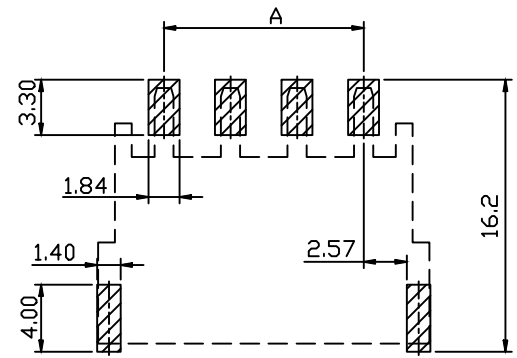

Mating PCB Detail

Circuit	Dimension(mm)			Circuit	Dimension(mm)		
	A	B	C		A	B	C
02	3.96	11.80	8.60	10	35.64	43.48	40.28
03	7.92	15.76	12.56	11	39.60	47.44	44.24
04	11.88	19.72	16.52	12	43.56	51.40	48.20
05	15.84	23.68	20.48	13	47.52	55.36	52.16
06	19.80	27.64	24.44	14	51.48	59.32	56.12
07	23.76	31.60	28.40	15	55.44	63.28	60.08
08	27.72	35.56	32.36	16	59.40	67.24	64.04
09	31.68	39.52	36.32				

**RHTECP** NINGBO RHT ELECTRONIC CO.,LTD

UNITS:mm	SHEET SIZE: A4			SCALE:---
0~3	3~18	18~50	50~120	
$\pm 0.12$	$\pm 0.15$	$\pm 0.3$	$\pm 0.5$	

DRWN BY PAN  
 CHK'D BY FENG  
 APPR BY ZHAN

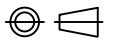
Ptich 3.96mm Horizontal SMT Wafer  
 THIRD ANGLE PROJECTION  
  
 RHTAY3.96A-XX-RM