

RoHS Compliance

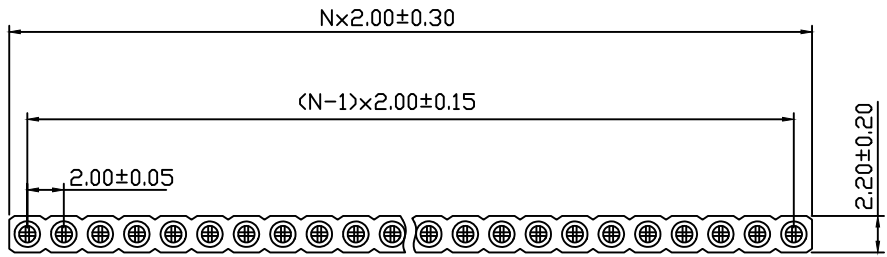

Material:

Housing: 30% Glass Filled PPS UL94V-0

Contacts: Beryllium Copper Or Phosphor Bronze

Plating: Gold 1.25u" Over 50u" Nickel

Electrical Characteristics:

Current Rating : 3.0AMP

Insulator Resistance: 1000MΩ min

Contact Resistance: 10mΩ max.

Operating Temperature: -40°C ~ +105°C

Order Information:

RHTAY09B-1-XX-S-Y

IC Socket

RDW

1-Single Layer

2-Double Layer

No. of 02~80 Pins

Type: S-Straight Pin

R-Right Angle Pin T-SMT Pin

Y-Imported Beryllium Copper

NDNE-Domestic Phosphor Bronze

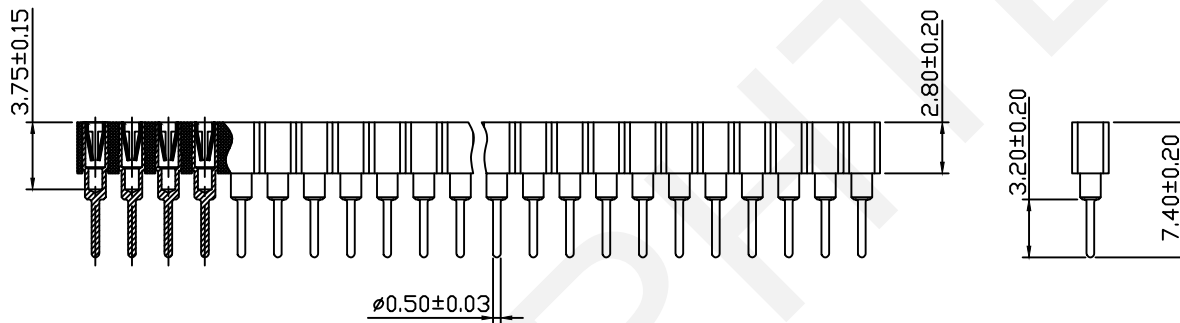

**RHTECP** NINGBO RHT ELECTRONIC CO.,LTD

UNITS:mm	SHEET SIZE: A4			SCALE:---	DRWN BY PAN
0~3	3~18	18~50	50~120	CHK'D BY FENG	
±0.12	±0.15	±0.3	±0.5	APPR BY ZHAN	

2.00mm Pitch SIP Socket Connector

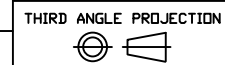

RHTAY09B-1-XX-S-Y

RoHS Compliance

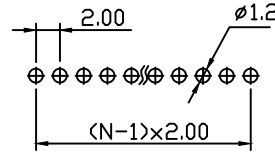
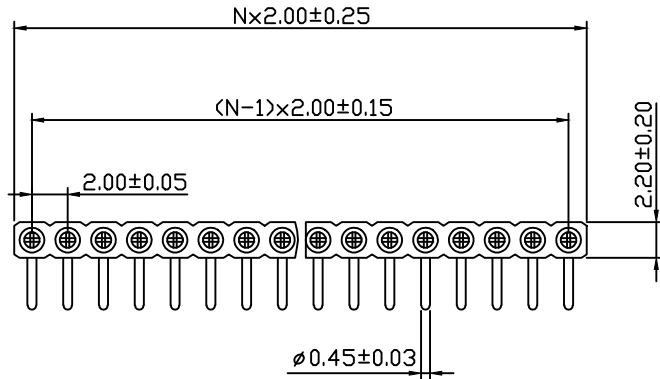

Recommended PCB Layout (Top Side)  
(PLB BOARD TOLERANCE ±0.05)

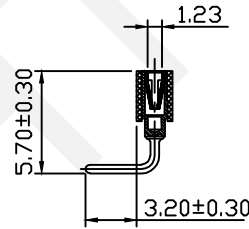
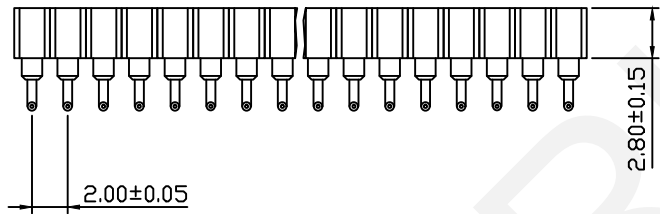

Material:

Housing: 30% Glass Filled PPS UL94V-0

Contacts: Beryllium Copper Or Phosphor Bronze

Plating: Gold 1.25u" Over 50u" Nickel

Electrical Characteristics:

Current Rating : 3.0AMP

Insulator Resistance: 1000MΩ min

Contact Resistance: 10mΩ max.

Operating Temperature: -40°C ~ +105°C

Order Information:

RHTAY09B-1-XX-R-Y

IC Socket

ROW

1-Single Layer

2-Double Layer

No. of 02~80 Pins

Type: S-Straight Pin

R-Right Angle Pin T-SMT Pin

Y-Imported Beryllium Copper

NONE-Domestic Phosphor Bronze

**RHTECP** NINGBO RHT ELECTRONIC CO.,LTD

UNITS:mm	SHEET SIZE: A4	SCALE:---	DRWN BY PAN
0~3	3~18	18~50	50~120
±0.12	±0.15	±0.3	±0.5

CHK'D BY FENG  
APPR BY ZHAN

2.00mm Pitch SIP Socket Connector

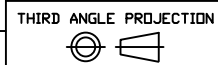

RHTAY09B-1-XX-R-Y

RoHS Compliance

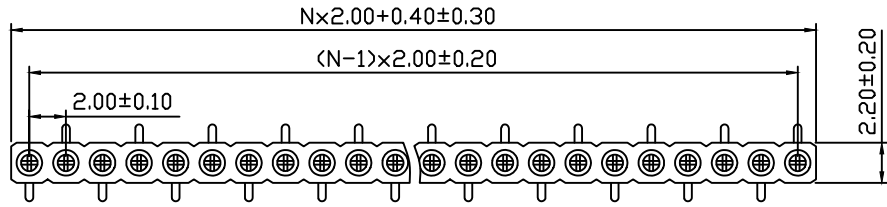

T2 Type

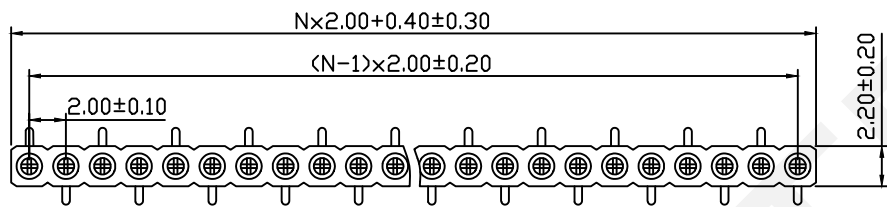

T1 Type

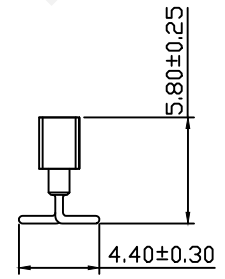
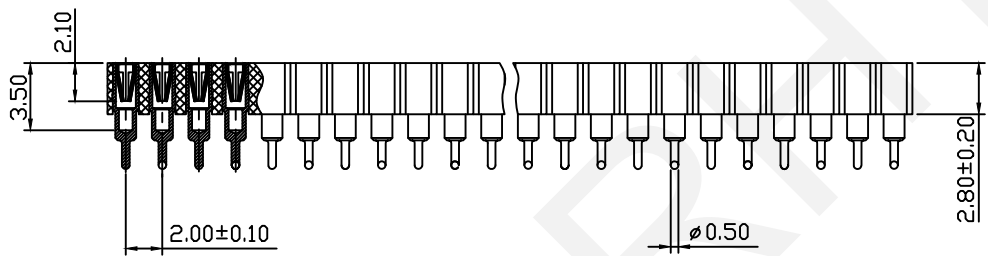

Material:  
 Housing: 30% Glass Filled PPS UL94V-0  
 Contacts: Beryllium Copper Or Phosphor Bronze  
 Plating: Gold 1.25u" Over 50u" Nickel

Electrical Characteristics:  
 Current Rating : 3.0AMP  
 Insulator Resistance: 1000MΩ min  
 Contact Resistance: 10mΩ max.  
 Operating Temperature: -40°C ~ +105°C

Order Information:  
 RHTAY09B-1-XX-T1-Y

IC Socket  
 ROW  
 1-Single Layer  
 2-Double Layer  
 No. of 02~80 Pins  
 SMT Type:  
 T1 Type, T2 Type  
 Y-Imported Beryllium Copper  
 NONE-Domestic Phosphor Bronze



NINGBO RHT ELECTRONIC CO.,LTD

UNITS:mm	SHEET SIZE: A4				SCALE:---	DRWN BY PAN
0~3	3~18	18~50	50~120	CHK'D BY FENG	THIRD ANGLE PROJECTION	
±0.12	±0.15	±0.3	±0.5	APPR BY ZHAN	RHTAY09B-1-XX-T1-Y	

2.00mm Pitch SIP Socket Connector

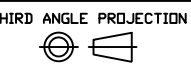

RHTAY09B-1-XX-T1-Y

RoHS Compliance

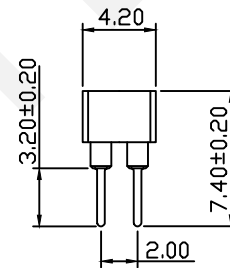
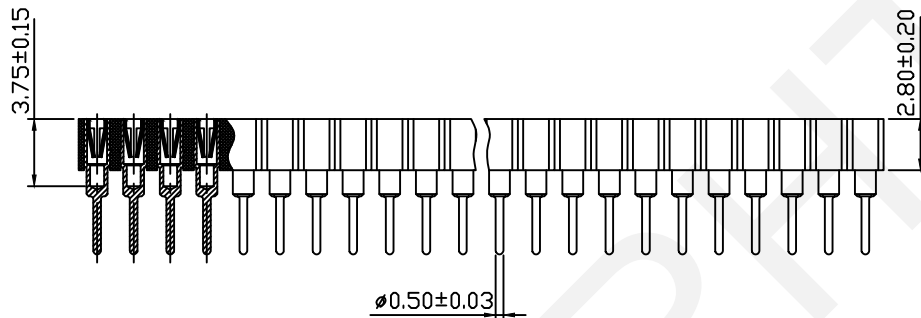
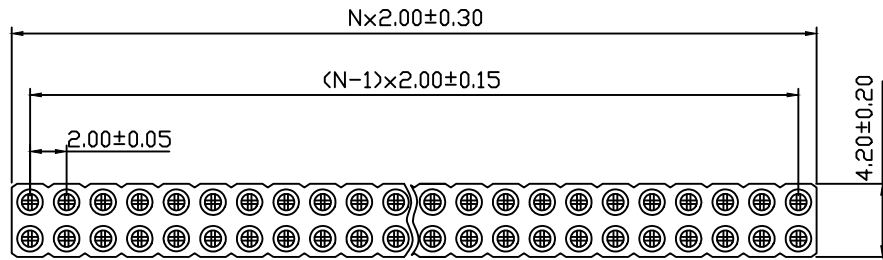

Material:

Housing: 30% Glass Filled PPS UL94V-0

Contacts: Beryllium Copper Or Phosphor Bronze

Plating: Gold 1.25u" Over 50u" Nickel

Electrical Characteristics:

Current Rating : 3.0AMP

Insulator Resistance: 1000MΩ min

Contact Resistance: 10mΩ max.

Operating Temperature: -40°C ~ +105°C

Order Information:

RHTAY09B-2-XX-S-Y

IC Socket

RDW

1-Single Layer

2-Double Layer

No. of 02~80 Pins

Type: S-Straight Pin

R-Right Angle Pin T-SMT Pin

Y-Imported Beryllium Copper

NDNE-Domestic Phosphor Bronze

**RHTECP** NINGBO RHT ELECTRONIC CO.,LTD

UNITS:mm	SHEET SIZE: A4	SCALE:---	DRWN BY PAN
0~3	3~18	18~50	50~120
±0.12	±0.15	±0.3	±0.5

CHK'D BY FENG  
APPR BY ZHAN

2.00mm Pitch SIP Socket Connector  
THIRD ANGLE PROJECTION  
RHTAY09B-2-XX-S-Y

RoHS Compliance

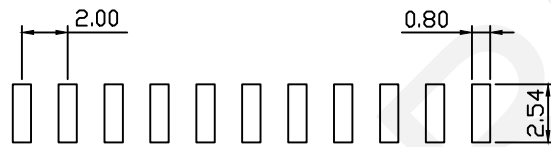
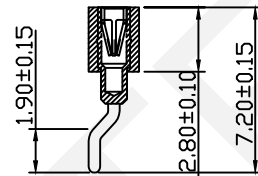
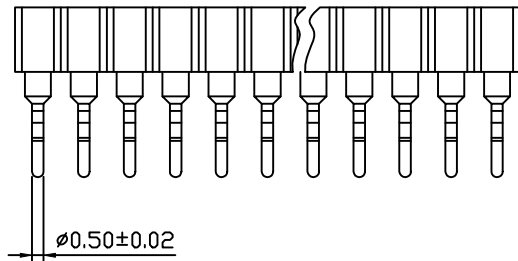
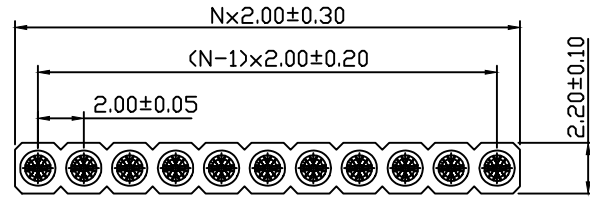

Recommended P.C.B Layout(±0.05)

Technical Data

Pin(outer sleeve):Brass,Machined CuZn38Pb2  
 Clp(Contact 6 Finger):Beryllium Copper,Heat Teated  
 Insulator:PA6T UL94V-0 Colour:White  
 Current Rating:1Amps  
 Mating Pin $\phi$ :0.40/0.66mm  
 Forces:(Polished Steel Gauge $\phi$ 0.46mm)  
 -Insertion:0.7N typ  
 -Withdrawal:0.4N typ  
 Mechanical Life:min 500Cycles  
 Contact Resistance:Max 10m  
 Dielectric Strength:Min 1000V RMS  
 Operating Temperature:-40°C to+ 105°C  
 Soldering Temperature:+255°C

Order Information:

RHTAY09B-1-XX-RM-Y

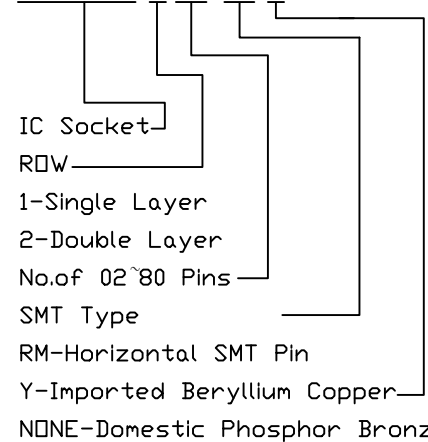

**RHTECP** NINGBO RHT ELECTRONIC CO.,LTD

UNITS:mm	SHEET SIZE: A4			SCALE:---	DRWN BY PAN
0~3	3~18	18~50	50~120	CHK'D BY FENG	
±0.12	±0.15	±0.3	±0.5	APPR BY ZHAN	

Pitch 2.00mm Adapter Connector,Pin Length:7.40mm,Plastic height:2.80mm

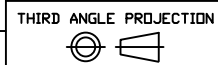

RHTAY09B-1-XX-RM-Y

RoHS Compliance

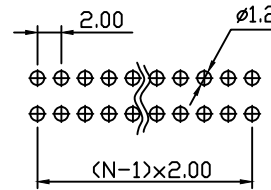
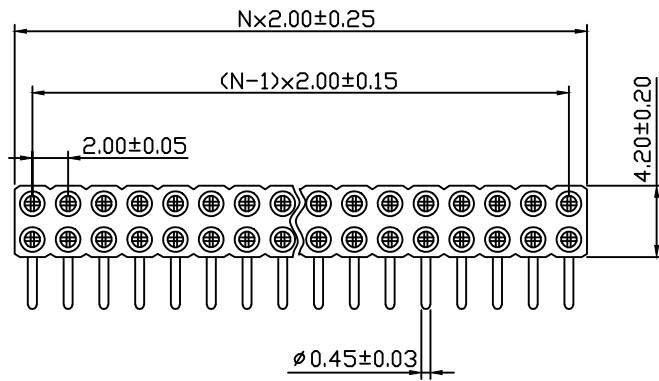

Recommended PCB Layout (Top Side)  
(PLB BOARD TOLERANCE ±0.05)

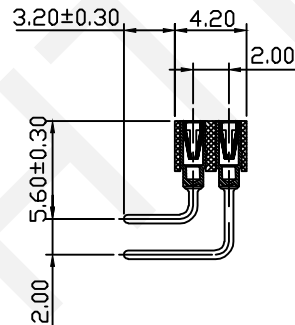
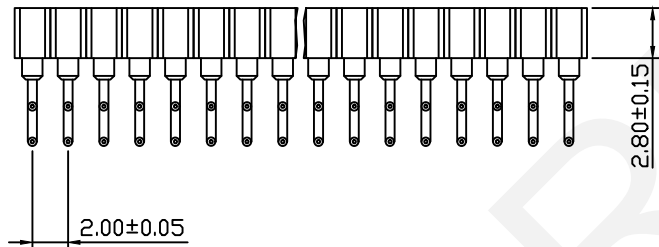

Material:

Housing: 30% Glass Filled PPS UL94V-0

Contacts: Beryllium Copper Or Phosphor Bronze

Plating: Gold 1.25u" Over 50u" Nickel

Electrical Characteristics:

Current Rating : 3.0AMP

Insulator Resistance: 1000MΩ min

Contact Resistance: 10mΩ max.

Operating Temperature: -40°C ~ +105°C

Order Information:

RHTAY09B-2-XX-R-Y

IC Socket

ROW

1-Single Layer

2-Double Layer

No. of 02~80 Pins

Type: S-Straight Pin

R-Right Angle Pin T-SMT Pin

Y-Imported Beryllium Copper

NONE-Domestic Phosphor Bronze

**RHTECP** NINGBO RHT ELECTRONIC CO.,LTD

UNITS:mm	SHEET SIZE: A4	SCALE:---	DRWN BY PAN
0~3	3~18	18~50	50~120
±0.12	±0.15	±0.3	±0.5

CHK'D BY FENG  
APPR BY ZHAN

2.00mm Pitch SIP Socket Connector

THIRD ANGLE PROJECTION

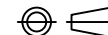

RHTAY09B-2-XX-R-Y

RoHS Compliance

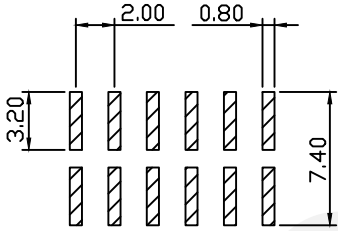
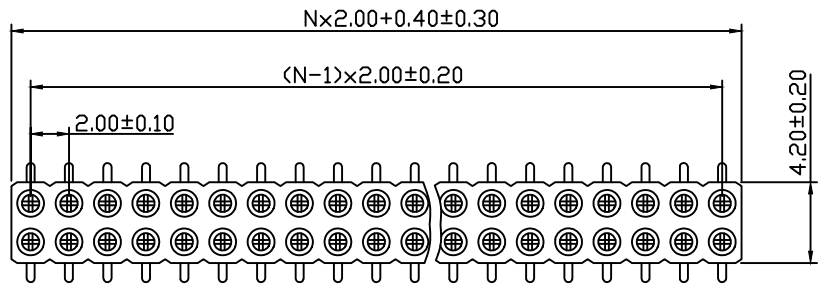

Recommended PCB Layout (Top Side)  
(PLB BOARD TOLERANCE ±0.05)

Material:

Housing: 30% Glass Filled PPS UL94V-0  
 Contacts: Beryllium Copper Or Phosphor Bronze  
 Plating: Gold 1.25u" Over 50u" Nickel

Electrical Characteristics:

Current Rating : 3.0AMP  
 Insulator Resistance: 1000MΩ min  
 Contact Resistance: 10mΩ max.  
 Operating Temperature: -40°C ~ +105°C

Order Information:

RHTAY09B-2-XX-T-Y

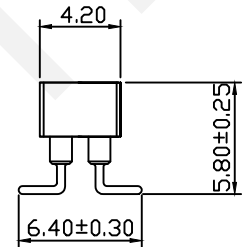
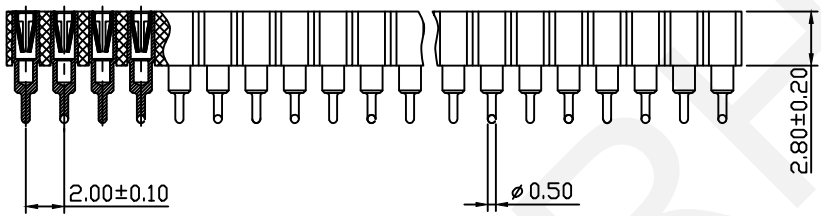
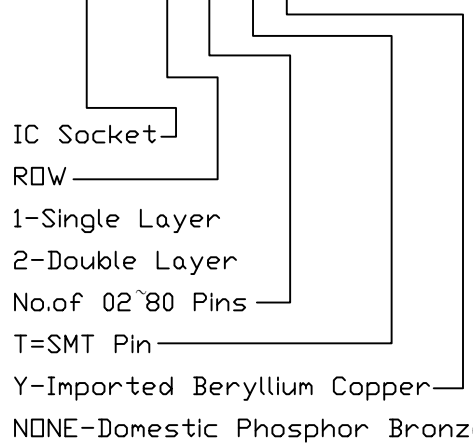

NINGBO RHT ELECTRONIC CO.,LTD

UNITS:mm	SHEET SIZE: A4	SCALE:---	DRWN BY PAN
0~3	3~18	18~50	50~120
±0.12	±0.15	±0.3	±0.5

CHK'D BY FENG  
 APPR BY ZHAN

2.00mm Pitch SIP Socket Connector

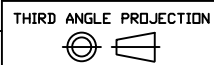

RHTAY09B-2-XX-T-Y