

RHTECP NINGBO RHT ELECTRONIC CO.,LTD

UNITS:mm	SHEET SIZE: A4				SCALE:----	DRWN BY PAN
0~3	3~18	18~50	50~120	CHK'D BY FENG	THIRD ANGLE PROJECTION	
±0.12	±0.15	±0.3	±0.5	APPR BY ZHAN	RHTAYIM-014-6P-R	

SIM CARD CONN:PUSH PUSH,
R/A,6P,SMD With CD Pin

THIRD ANGLE PROJECTION

RHTAYIM-014-6P-R

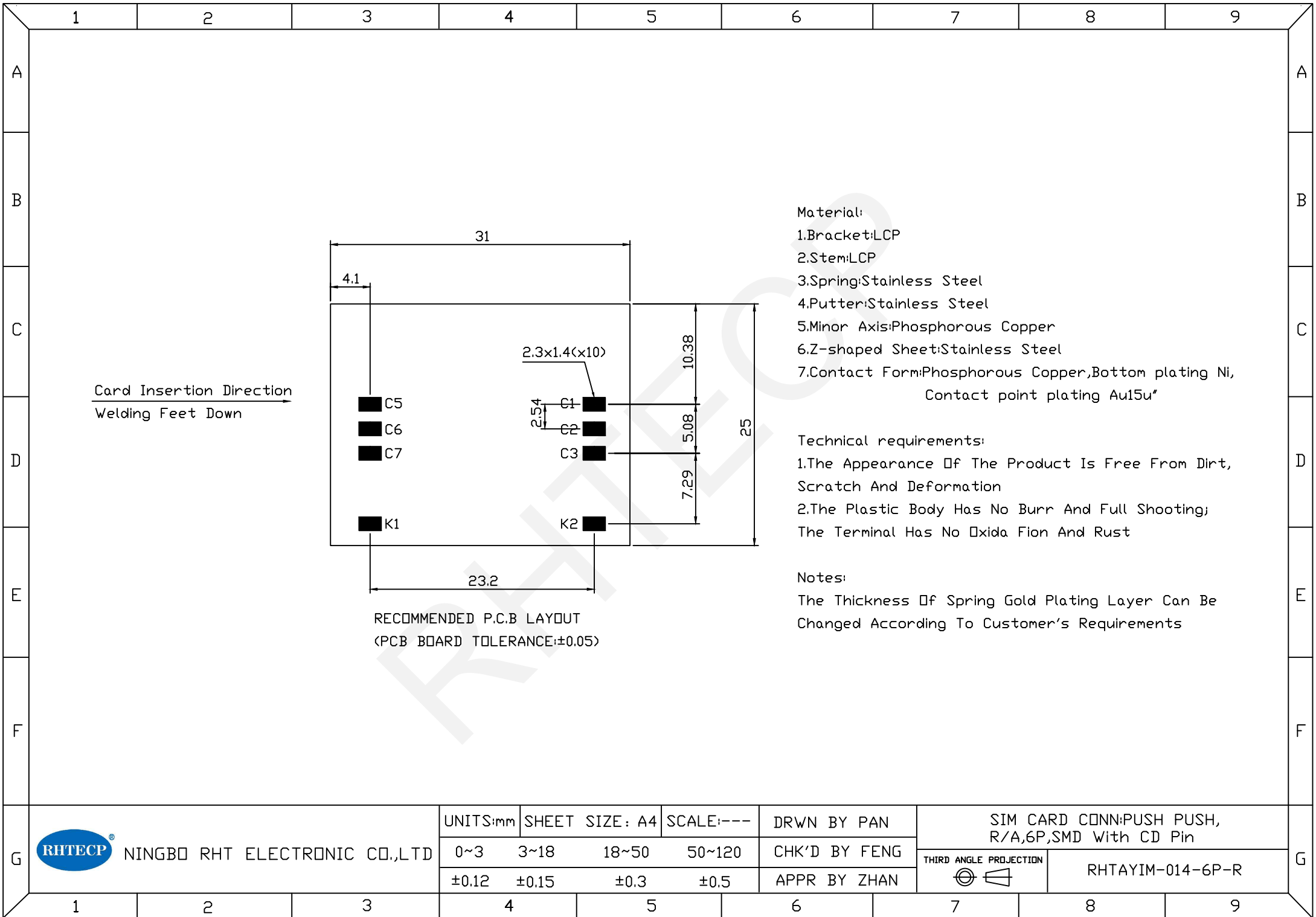

RECOMMENDED P.C.B LAYOUT
(PCB BOARD TOLERANCE:±0.05)

Material:

- 1.Bracket:LCP
- 2.Stem:LCP
- 3.Spring:Stainless Steel
- 4.Putter:Stainless Steel
- 5.Minor Axis:Phosphorous Copper
- 6.Z-shaped Sheet:Stainless Steel
- 7.Contact Form:Phosphorous Copper,Bottom plating Ni,
Contact point plating Au15u"

Technical requirements:

- 1.The Appearance Of The Product Is Free From Dirt, Scratch And Deformation
- 2.The Plastic Body Has No Burr And Full Shooting;
The Terminal Has No Oxida Fion And Rust

Notes:

The Thickness Of Spring Gold Plating Layer Can Be Changed According To Customer's Requirements



NINGBO RHT ELECTRONIC CO.,LTD

UNITS:mm	SHEET SIZE: A4		SCALE:---	
0~3	3~18	18~50	50~120	
±0.12	±0.15	±0.3	±0.5	

DRWN BY PAN
CHK'D BY FENG
APPR BY ZHAN

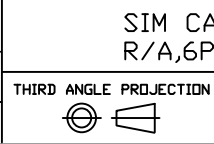

SIM CARD CONN:PUSH PUSH,
R/A,6P,SMD With CD Pin

RHTAYIM-014-6P-R

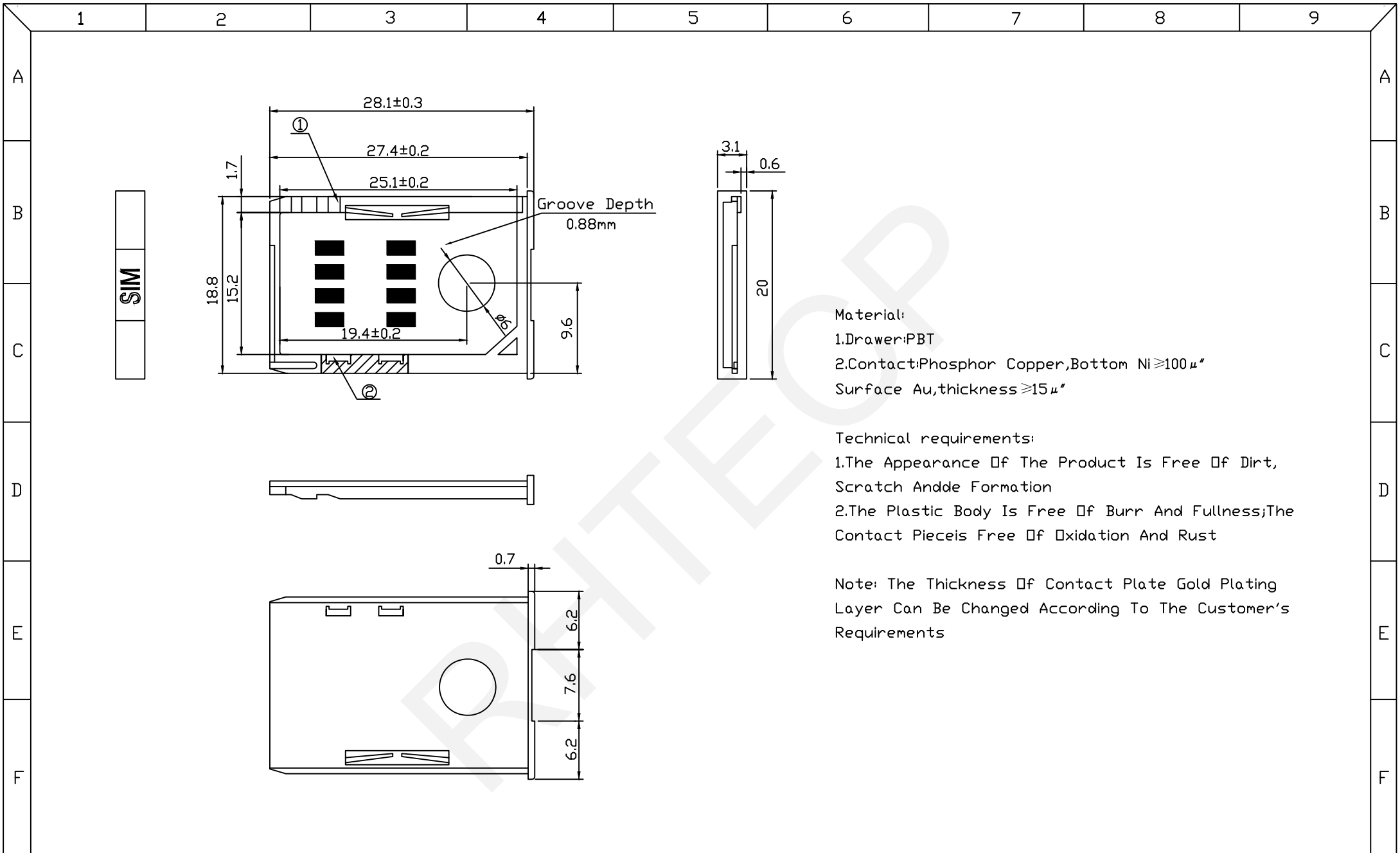

Material:

- 1.Drawer:PBT
- 2.Contact:Phosphor Copper,Bottom Ni \geq 100 μ "
- Surface Au,thickness \geq 15 μ "

Technical requirements:

- 1.The Appearance Of The Product Is Free Of Dirt, Scratch Andde Formation
- 2.The Plastic Body Is Free Of Burr And Fullness;The Contact Pieces Free Of Oxidation And Rust

Note: The Thickness Of Contact Plate Gold Plating Layer Can Be Changed According To The Customer's Requirements

G	NINGBO RHT ELECTRONIC CO.,LTD			UNITS:mm	SHEET SIZE: A4	SCALE:---	DRWN BY PAN	SIM CARD CONN:PUSH PUSH, R/A,6P,SMD With CD Pin			G		
				0~3	3~18	18~50	50~120	CHK'D BY FENG	THIRD ANGLE PROJECTION 			RHTAYIM-014-6P-R	
				±0.12	±0.15	±0.3	±0.5	APPR BY ZHAN					
1	2	3	4	5	6	7	8	9					

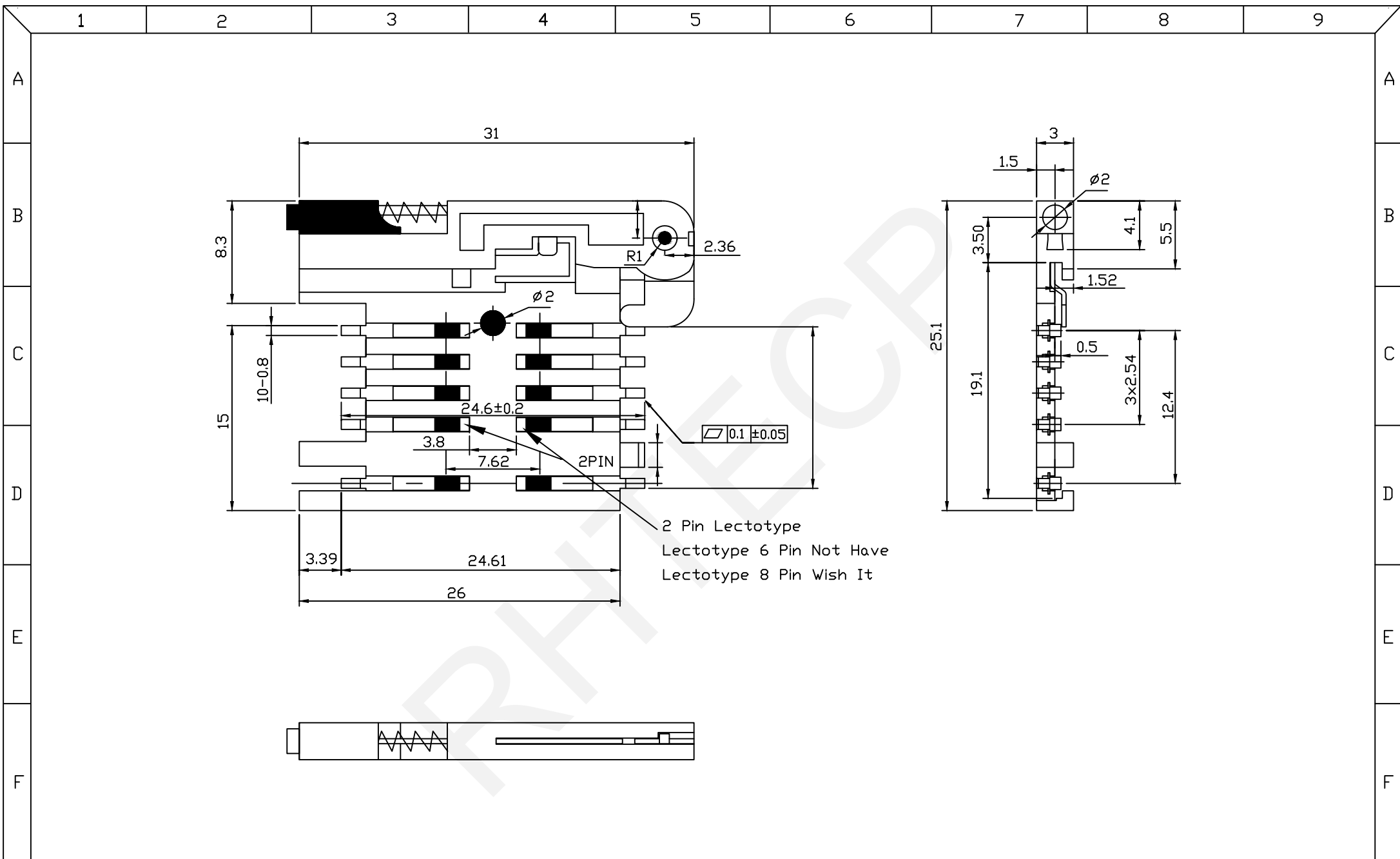

NINGBO RHT ELECTRONIC CO.,LTD

UNITS:mm

SHEET SIZE: A4

SCALE:---

DRWN BY PAN

SIM CARD CONN:PUSH PUSH,
R/A,6P&8P,SMD With CD Pin

0~3

3~18

18~50

50~120

CHK'D BY FENG

THIRD ANGLE PROJECTION

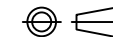

RHTAYIM-014-8P-R

±0.12

±0.15

±0.3

±0.5

APPR BY ZHAN

1

2

3

4

5

6

7

8

9

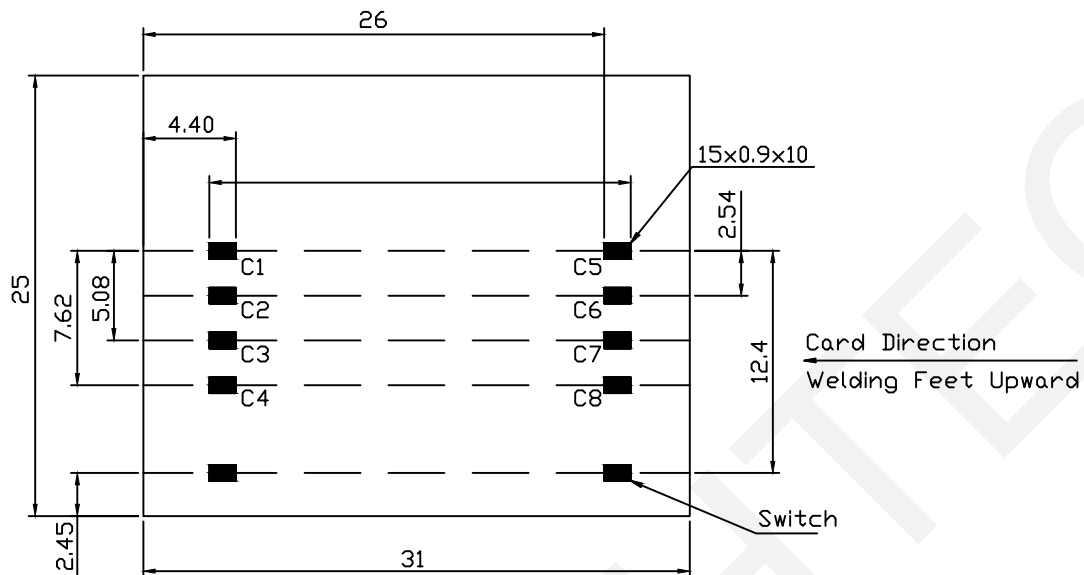

RECOMMENDED P.C.B. LAYOUT

Material:
 Housing Material: LCP UL94V-0
 Contact Material: Tin-Bronze
 Package: Tape And Reel Package

Electrical Characteristics:
 Voltage Rating: 5V (AC, DC) Max
 Current Rating: 10mA (AC, DC) Max
 Withstand Voltage: 500V AC/1Minute
 Insulation Resistance: $\geq 1000\Omega$ Min At 500V AC
 Contact Resistance: $\leq 30\Omega$
 Life: > 10000 Cycles
 Operating Temperature: $-45^{\circ}\text{C} \sim +105^{\circ}\text{C}$



NINGBO RHT ELECTRONIC CO., LTD

UNITS:mm	SHEET SIZE: A4				SCALE:---	DRWN BY PAN
0~3	3~18	18~50	50~120	CHK'D BY FENG	THIRD ANGLE PROJECTION	
± 0.12	± 0.15	± 0.3	± 0.5	APPR BY ZHAN	RHTAYIM-014-8P-R	

SIM CARD CONN: PUSH PUSH,
 R/A, 6P&8P, SMD With CD Pin



RHTAYIM-014-8P-R

SIM

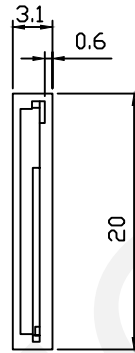
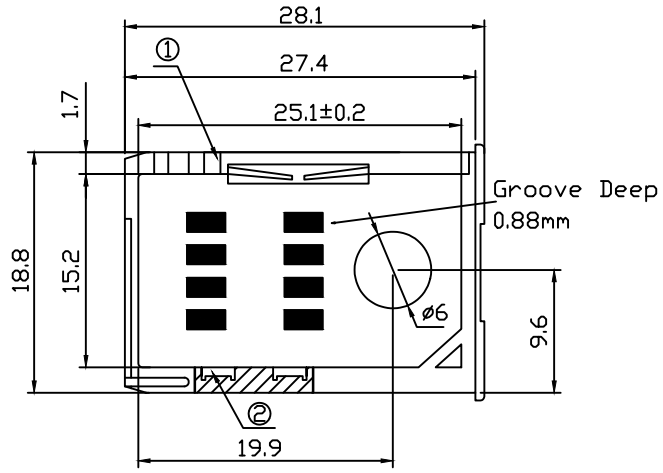

Material:

- 1.Drawer:PC
- 2.Contact:Phosphor Copper,Bottom Ni \geq 100 μ "
- Surface Au,thickness \geq 15 μ "

Technical requirements:

- 1.The Appearance Of The Product Is Free Of Dirt, Scratch Andde Formation
- 2.The Plastic Body Is Free Of Burr And Fullness;The Contact Pieceis Free Of Oxidation And Rust

Note: The Thickness Of Contact Plate Gold Plating Layer Can Be Changed According To The Customer's Requirements

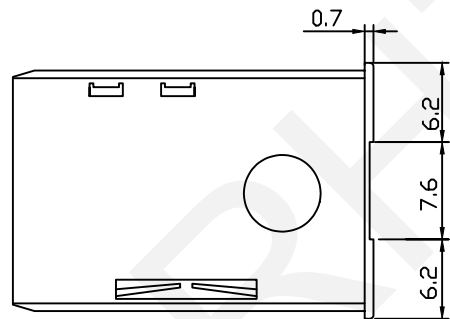
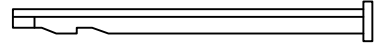

NINGBO RHT ELECTRONIC CO.,LTD

UNITS:mm	SHEET SIZE: A4				SCALE:---	DRWN BY PAN
0~3	3~18	18~50	50~120	CHK'D BY FENG	THIRD ANGLE PROJECTION	
±0.12	±0.15	±0.3	±0.5	APPR BY ZHAN	RHTAYIM-014-8P-R	

SIM CARD CONN:PUSH PUSH,
R/A,6P&8P,SMD With CD Pin

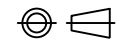

RHTAYIM-014-8P-R