

REFERENCE PCB LAYOUT
UNIT:MM TOLERANCE:±0.05

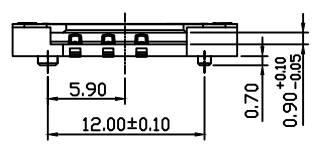

Material:
 Insulator Body:LCP, Color:Black
 Contact:Phosphor Bronze
 Plating:
 Finsh: Tin Gold Or Duplex Plated.
 Standard:Gold Flash All Over Nickel
 Electrical:
 Current Rating:0.5A
 Dielectric Withstanding Voltage:500V AC
 Insulation Resistance: 1000MΩ Min
 Contact Resistance:30mΩ Max.
 Life:10000 Cycles
 Operating Temperature:-45°C~+105°C

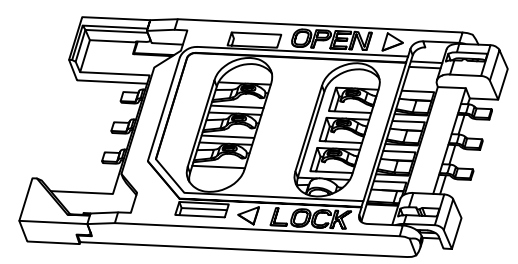

RHTECP NINGBO RHT ELECTRONIC CO.,LTD

UNITS:mm	SHEET SIZE: A4				SCALE:---	DRWN BY PAN
0~3	3~18	18~50	50~120	CHK'D BY FENG	THIRD ANGLE PROJECTION	
±0.12	±0.15	±0.3	±0.5	APPR BY ZHAN	RHTAYIM-010A-H2.5-6P-0-R	

SIM Card Connector, HINGED
 Type 6P With Post ,H2.5mm
 RHTAYIM-010A-H2.5-6P-0-R

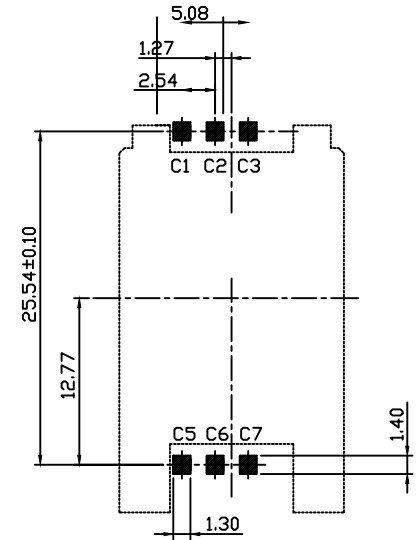
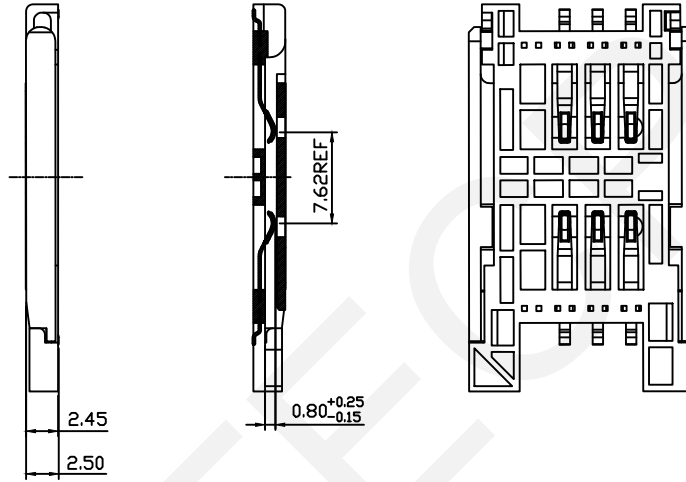
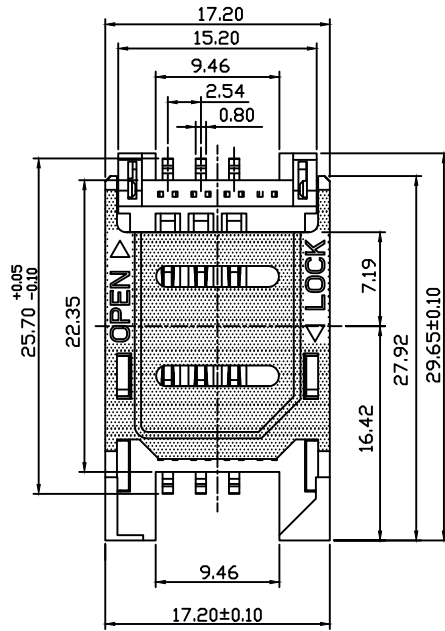

REFERENCE PCB LAYOUT
UNIT:MM TOLERANCE:±0.05

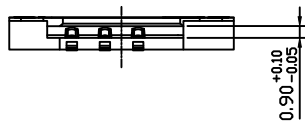

Material:
 Insulator Body:LCP, Color:Black
 Contact:Phosphor Bronze
 Plating:
 Finish: Tin Gold Or Duplex Plated.
 Standard:Gold Flash All Over Nickel
 Electrical:
 Current Rating:0.5A
 Dielectric Withstanding Voltage:500V AC
 Insulation Resistance: 1000MΩ Min
 Contact Resistance:30mΩ Max.
 Life:10000 Cycles
 Operating Temperature:-45°C~+105°C

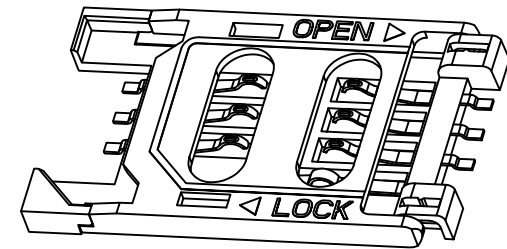

RHTECP NINGBO RHT ELECTRONIC CO.,LTD

UNITS:mm	SHEET SIZE: A4			SCALE:---	DRWN BY PAN
0~3	3~18	18~50	50~120	CHK'D BY FENG	
±0.12	±0.15	±0.3	±0.5	APPR BY ZHAN	

SIM Card Connector,HINGED
 Type 6P Without Post ,H2.5mm
 THIRD ANGLE PROJECTION
 RHTAYIM-010A-H2.5-6P-1-R

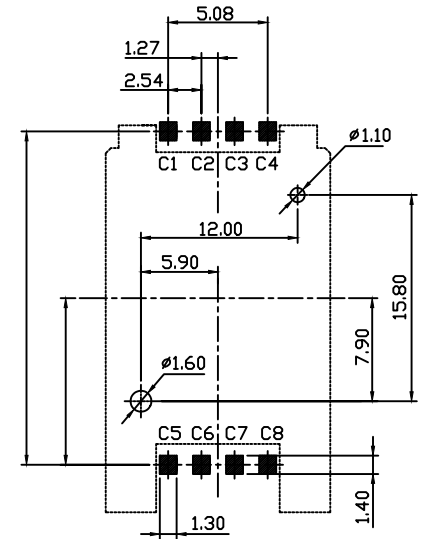
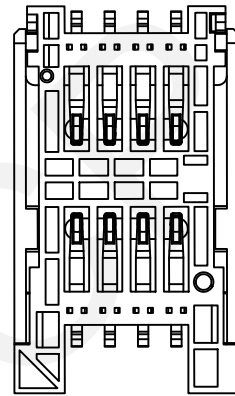
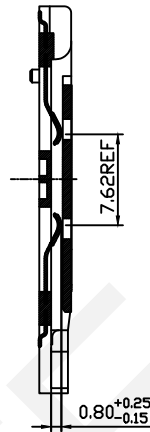
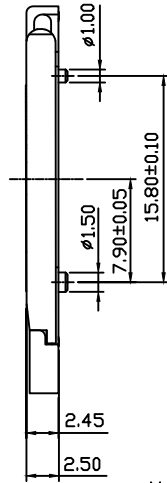
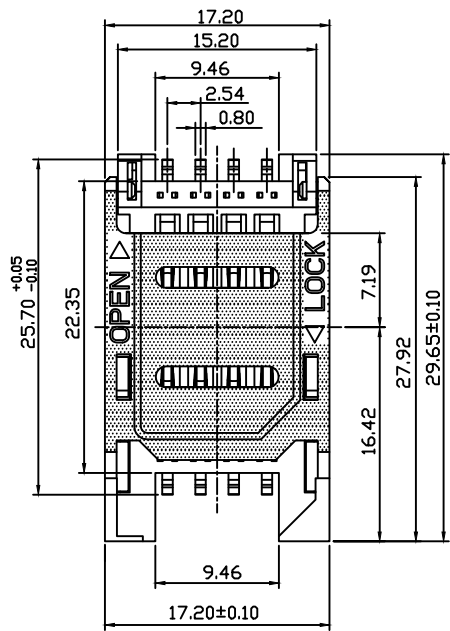

REFERENCE PCB LAYOUT
UNIT:MM TOLERANCE:±0.05

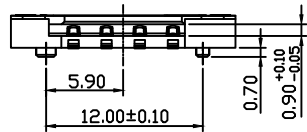

Material:
 Insulator Body:LCP. Color:Black
 Contact:Phosphor Bronze
 Plating:
 Finish: Tin Gold Or Duplex Plated.
 Standard:Gold Flash All Over Nickel
 Electrical:
 Current Rating:0.5A
 Dielectric Withstanding Voltage:500V AC
 Insulation Resistance: 1000MΩ Min
 Contact Resistance:30mΩ Max.
 Life:10000 Cycles
 Operating Temperature:-45°C~+105°C

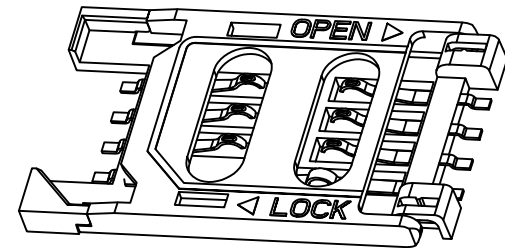

RHTECP NINGBO RHT ELECTRONIC CO.,LTD

UNITS:mm	SHEET SIZE: A4				SCALE:---	DRWN BY PAN
0~3	3~18	18~50	50~120	CHK'D BY FENG	THIRD ANGLE PROJECTION	
±0.12	±0.15	±0.3	±0.5	APPR BY ZHAN		

SIM Card Connector,HINGED
 Type 8P With Post ,H2.5mm
 RHTAYIM-010A-H2.5-8P-0-R

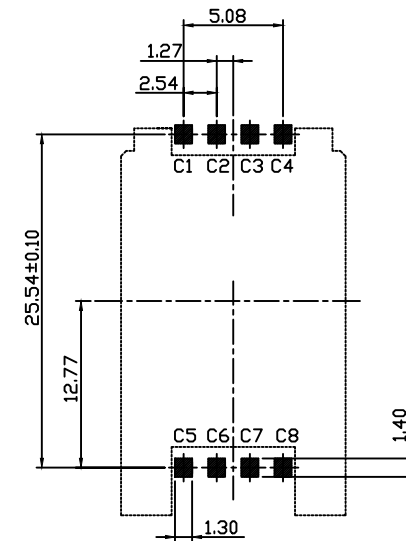
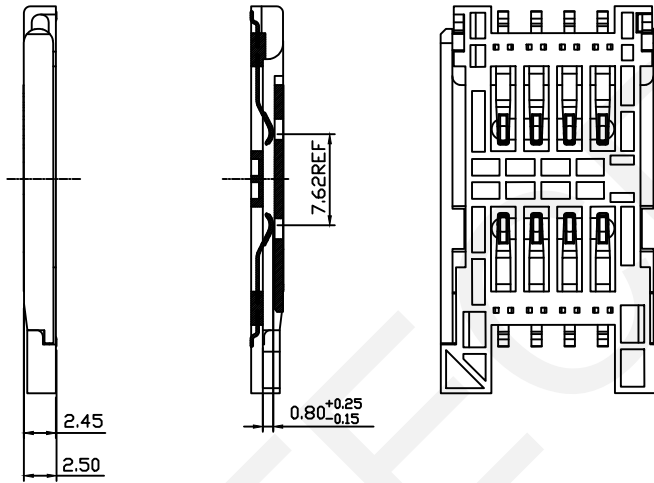
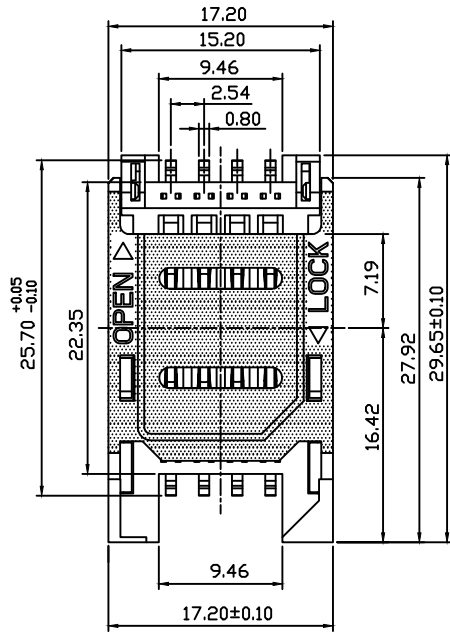

REFERENCE PCB LAYOUT
UNIT:MM TOLERANCE:±0.05

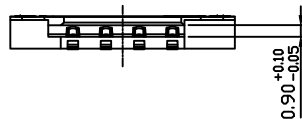

Material:
 Insulator Body:LCP. Color:Black
 Contact:Phosphor Bronze
 Plating:
 Finish: Tin Gold Or Duplex Plated.
 Standard:Gold Flash All Over Nickel
 Electrical:
 Current Rating:0.5A
 Dielectric Withstanding Voltage:500V AC
 Insulation Resistance: 1000MΩ Min
 Contact Resistance:30mΩ Max.
 Life:10000 Cycles
 Operating Temperature:-45°C~+105°C

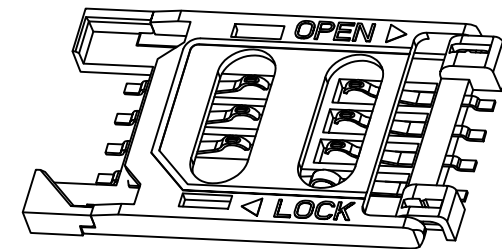

UNITS:mm	SHEET SIZE: A4				SCALE:---	DRWN BY PAN
0~3	3~18	18~50	50~120	CHK'D BY FENG	THIRD ANGLE PROJECTION	
±0.12	±0.15	±0.3	±0.5	APPR BY ZHAN	RHTAYIM-010A-H2.5-8P-1-R	

SIM Card Connector,HINGED
 Type 8P Without Post ,H2.5mm
 RHTAYIM-010A-H2.5-8P-1-R