

RoHS Compliant

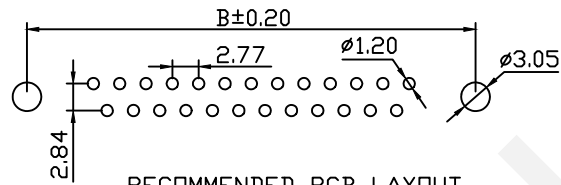
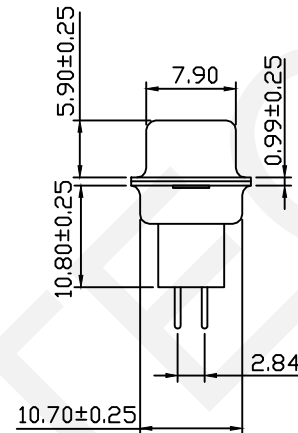
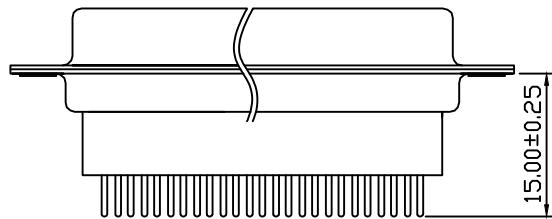
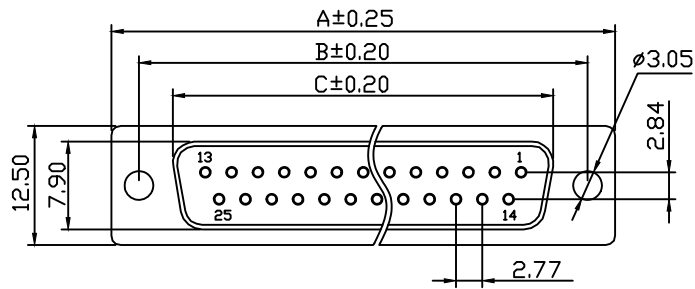

RECOMMENDED PCB LAYOUT
TOLERANCE:±0.05mm

Number of Contacts	DIMENSION		
	A±0.25	B±0.20	C±0.20
09	30.81	24.99	16.33
15	39.14	33.32	24.66
25	53.04	47.04	38.38
37	69.32	63.50	54.84

Material:

Housing:PBT+30% Glass Filled,UL94V-0

Contacts:Brass,Gold Plating Or

Gold Plating On Contact Arer,

Tin On Solder Tail.

Shell:Steel,Nickel Plating

Electrical Characteristics:

Current Rating: 5 AMP

Insulator Resistance:1000MΩ Min. at DC 500V

Withstanding Voltage: 500V AC (rms) For 1 Minute

Contact Resistance:20MΩ Max. Initial

Operating Temperature:-40°C~+105°C

Order Information:

RHTAY71-XX-F-B

D-SUB Connector, _____

2 Row Through Hole _____

XX-No.of 09,15,25,37 Pins _____

Connector Type:F-Female, _____

Housing Color: _____

B-Black L-Blue W-White

UNITS:mm	SHEET SIZE: A4	SCALE:---	DRWN BY PAN
0~3	3~18	18~50	50~120
±0.12	±0.15	±0.3	±0.5
CHK'D BY FENG		APPR BY ZHAN	

D-SUB Connector, High Profile,Through Hole,Female

THIRD ANGLE PROJECTION

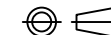

RHTAY71-XX-F-B



NINGBO RHT ELECTRONIC CO.,LTD

RoHS Compliant

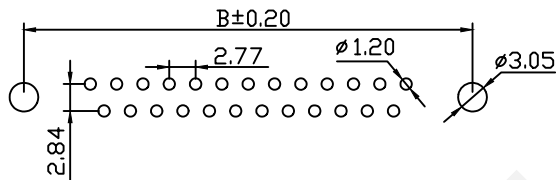
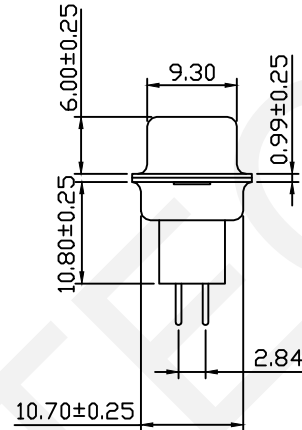
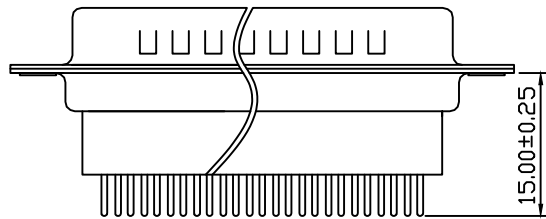
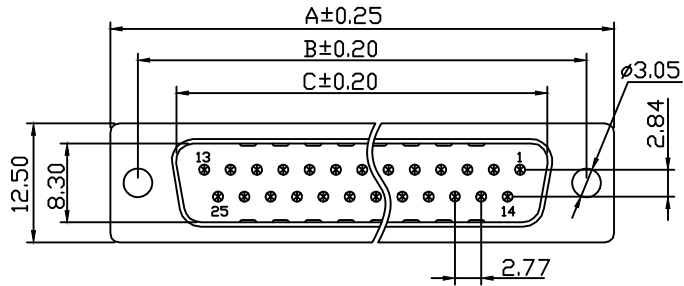

RECOMMENDED PCB LAYOUT
TOLERANCE:±0.05mm

Number of Contacts	DIMENSION		
	A±0.25	B±0.20	C±0.20
09	30.81	24.99	16.92
15	39.14	33.32	25.25
25	53.04	47.04	38.96
37	69.32	63.50	55.42

Material:

Housing:PBT+30% Glass Filled,UL94V-0

Contacts:Brass,Gold Plating Or

Gold Plating On Contact Area,

Tin On Solder Tail.

Shell:Steel,Nickel Plating

Electrical Characteristics:

Current Rating: 5 AMP

Insulator Resistance:1000MΩ Min. at DC 500V

Withstanding Voltage: 500V AC (rms) For 1 Minute

Contact Resistance:20MΩ Max. Initial

Operating Temperature:-40°C~+105°C

Order Information:

RHTAY71-XX-M-B

D-SUB Connector, _____

2 Row Through Hole _____

XX-No.of 09,15,25,37 Pins _____

Connector Type: M-Male, _____

Housing Color: _____

B-Black L-Blue W-White



NINGBO RHT ELECTRONIC CO.,LTD

UNITS:mm	SHEET SIZE: A4	SCALE:---	DRWN BY PAN
0~3	3~18	18~50	50~120
±0.12	±0.15	±0.3	±0.5

CHK'D BY FENG
APPR BY ZHAN

D-SUB Connector, High Profile,Through Hole, Male

THIRD ANGLE PROJECTION

RHTAY71-XX-M-B

RoHS Compliant

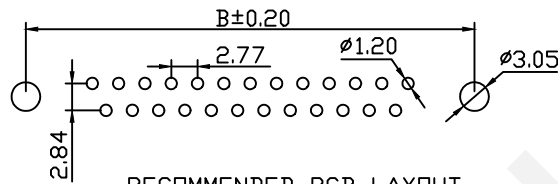
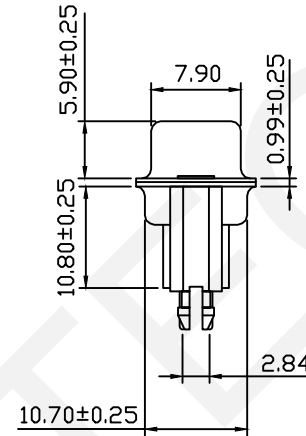
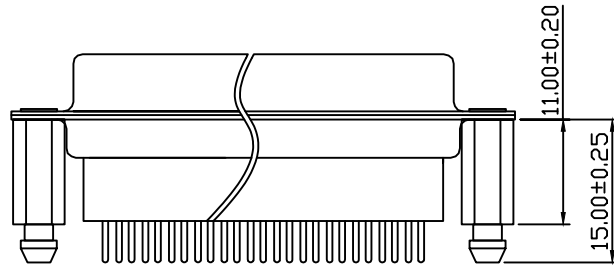
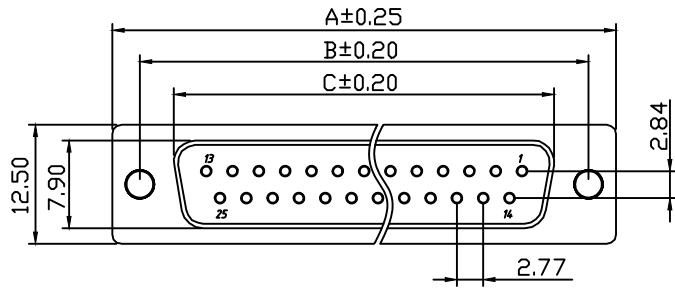

RECOMMENDED PCB LAYOUT
TOLERANCE:±0.05mm

Number of Contacts	DIMENSION		
	A±0.25	B±0.20	C±0.20
09	30.81	24.99	16.33
15	39.14	33.32	24.66
25	53.04	47.04	38.38
37	69.32	63.50	54.84

Material:

Housing:PBT+30% Glass Filled,UL94V-0

Contacts:Brass,Gold Plating Or

Gold Plating On Contact Arer,

Tin On Solder Tail.

Shell:Steel,Nickel Plating

Electrical Characteristics:

Current Rating: 5 AMP

Insulator Resistance1000MΩ Min. at DC 500V

Withstanding Voltage: 500V AC (rms) For 1 Minute

Contact Resistance:20MΩ Max. Initial

Operating Temperature:-40°C~+105°C

Order Information:

RHTAY71B-XX-F-B

D-SUB Connector, _____

2 Row Through Hole,After

Lock Screw Rivet Harpoons

XX-No.of 09,15,25,37 Pins _____

Connector Type:F-Female, _____

Housing Color: _____

B-Black L-Blue W-White

RHTECP NINGBO RHT ELECTRONIC CO.,LTD

UNITS:mm	SHEET SIZE: A4	SCALE:---	DRWN BY PAN
0~3	3~18	18~50	50~120
±0.12	±0.15	±0.3	±0.5

CHK'D BY FENG
APPR BY ZHAN

D-SUB Connector,High Profile,Through Hole,Female,Riveting Later Harpoons	
THIRD ANGLE PROJECTION	RHTAY71B-XX-F-B



RoHS Compliant

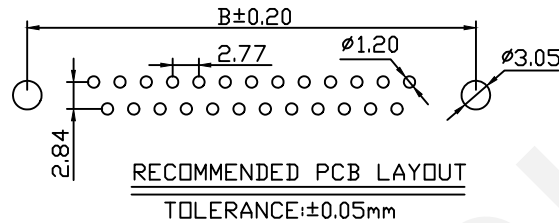
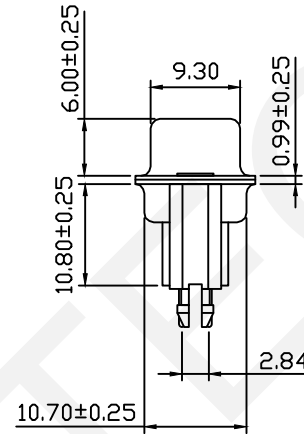
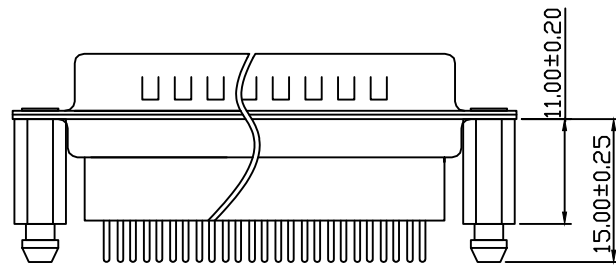
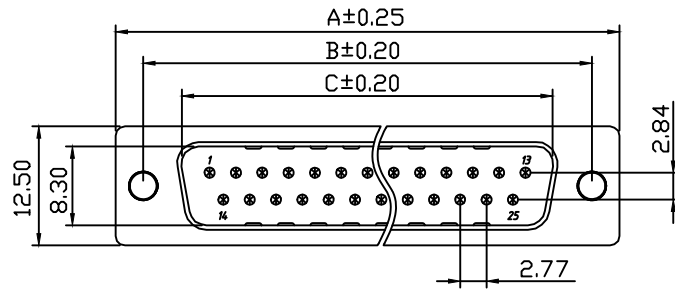

Number of Contacts	DIMENSION		
	A±0.25	B±0.20	C±0.20
09	30.81	24.99	16.92
15	39.14	33.32	25.25
25	53.04	47.04	38.96
37	69.32	63.50	55.42

Material:

Housing: PBT+30% Glass Filled, UL94V-0

Contacts: Brass, Gold Plating Or

Gold Plating On Contact Area,

Tin On Solder Tail.

Shell: Steel, Nickel Plating

Electrical Characteristics:

Current Rating: 5 AMP

Insulator Resistance: 1000MΩ Min. at DC 500V

Withstanding Voltage: 500V AC (rms) For 1 Minute

Contact Resistance: 20MΩ Max. Initial

Operating Temperature: -40°C ~ +105°C

Order Information:

RHTAY71B-XX-M-B

D-SUB Connector, _____

2 Row Through Hole, After

Lock Screw Rivet Harpoons

XX-No. of 09, 15, 25, 37 Pins _____

Connector Type: M-Male, _____

Housing Color: _____

B-Black L-Blue W-White

UNITS:mm	SHEET SIZE: A4	SCALE: ---	DRWN BY PAN
0~3	3~18	18~50	50~120
±0.12	±0.15	±0.3	±0.5
CHK'D BY FENG		APPR BY ZHAN	

D-SUB Connector, High Profile, Through Hole, Male, Riveting Later Harpoons	
THIRD ANGLE PROJECTION	RHTAY71B-XX-M-B



NINGBO RHT ELECTRONIC CO., LTD

RoHS Compliant

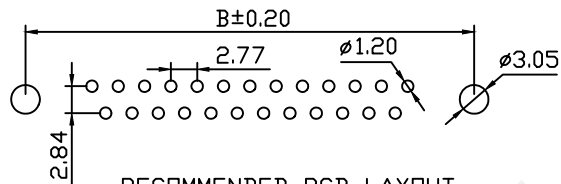
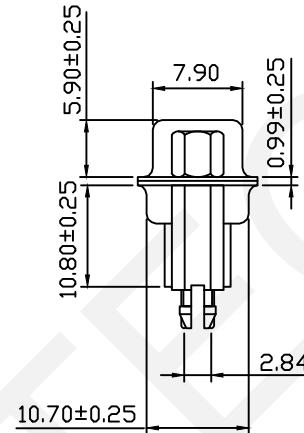
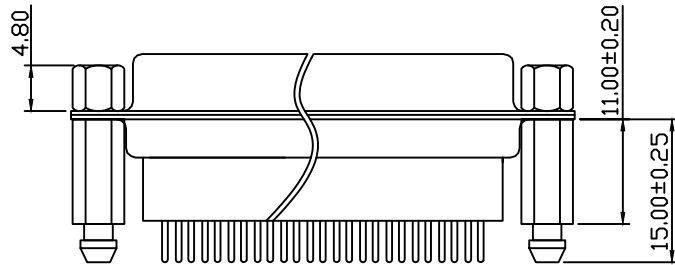
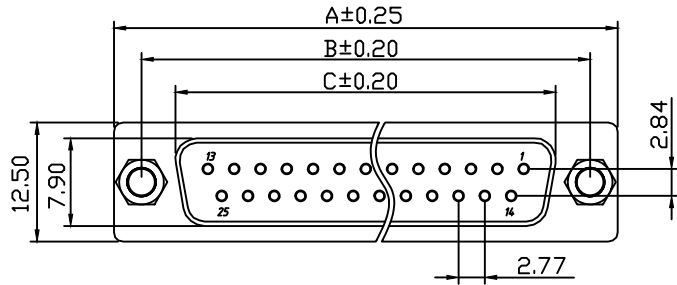

RECOMMENDED PCB LAYOUT
TOLERANCE:±0.05mm

Number of Contacts	DIMENSION		
	A±0.25	B±0.20	C±0.20
09	30.81	24.99	16.33
15	39.14	33.32	24.66
25	53.04	47.04	38.38
37	69.32	63.50	54.84

Material:

Housing:PBT+30% Glass Filled,UL94V-0

Contacts:Brass,Gold Plating Or

Gold Plating On Contact Area,

Tin On Solder Tail.

Shell:Steel,Nickel Plating

Electrical Characteristics:

Current Rating: 5 AMP

Insulator Resistance1000MΩ Min. at DC 500V

Withstanding Voltage: 500V AC (rms) For 1 Minute

Contact Resistance:20MΩ Max. Initial

Operating Temperature:-40°C~+105°C

Order Information:

RHTAY71C-XX-F-B

D-SUB Connector, _____

2 Row Through Hole,After

Lock Screw Rivet Harpoons

XX-No.of 09,15,25,37 Pins _____

Connector Type:F-Female, _____

Housing Color: _____

B-Black L-Blue W-White



NINGBO RHT ELECTRONIC CO.,LTD

UNITS:mm	SHEET SIZE: A4	SCALE:---	DRWN BY PAN
0~3	3~18	18~50	50~120
±0.12	±0.15	±0.3	±0.5

CHK'D BY FENG
APPR BY ZHAN

D-SUB Connector,High Profile,Through Hole,Female, Riveting Later Harpoons After Lock Screw Rivet Harpoons	
THIRD ANGLE PROJECTION	RHTAY71C-XX-F-B

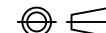

RoHS Compliant

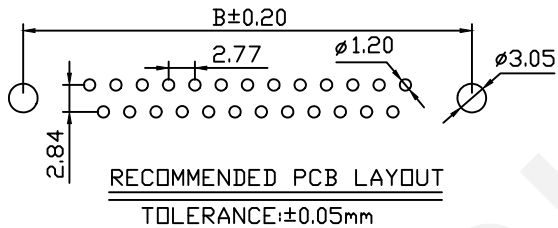
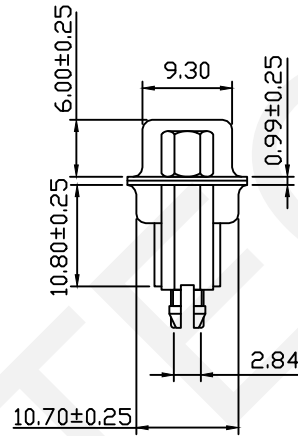
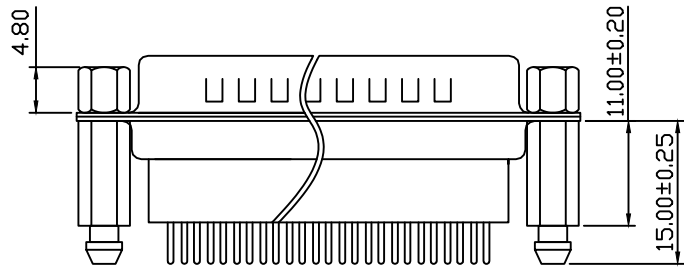
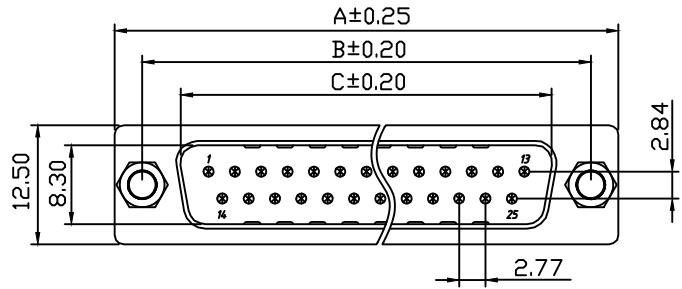

Material:

Housing: PBT+30% Glass Filled, UL94V-0

Contacts: Brass, Gold Plating Or

Gold Plating On Contact Area,

Tin On Solder Tail.

Shell: Steel, Nickel Plating

Electrical Characteristics:

Current Rating: 5 AMP

Insulator Resistance: 1000MΩ Min. at DC 500V

Withstanding Voltage: 500V AC (rms) For 1 Minute

Contact Resistance: 20MΩ Max. Initial

Operating Temperature: -40°C ~ +105°C

Order Information:

RHTAY71C-XX-M-B

D-SUB Connector, _____

2 Row Through Hole, After

Lock Screw Rivet Harpoons

XX-No. of 09, 15, 25, 37 Pins _____

Connector Type: M-Male, _____

Housing Color: _____

B-Black L-Blue W-White

Number of Contacts	DIMENSION		
	A±0.25	B±0.20	C±0.20
09	30.81	24.99	16.92
15	39.14	33.32	25.25
25	53.04	47.04	38.96
37	69.32	63.50	55.42

UNITS:mm SHEET SIZE: A4 SCALE: --- DRWN BY PAN

0~3 3~18 18~50 50~120 CHK'D BY FENG

±0.12 ±0.15 ±0.3 ±0.5 APPR BY ZHAN

D-SUB Connector, High Profile, Through Hole, Male, Riveting Later Harpoons After Lock Screw Rivet Harpoons

THIRD ANGLE PROJECTION

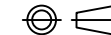

RHTAY71C-XX-M-B



NINGBO RHT ELECTRONIC CO., LTD