

No Locking Pate
B Type Ground Link

Electrical Specification:
 Contact Resistance: $\leq 0.03\Omega$
 Insulation Resistance: $\geq 100m\Omega$
 Withstand Voltage: 500V AC (50Hz)/minute
 Rated Load: 50V DC, 1A
 Insertion And Extraction Force: 4-40N
 Temperature Range: $-30^{\circ}C$ to $+80^{\circ}C$

Order Information:

RHTAYLR-S09-03-F-R-W-N

XLR Jack Series.

03=3 Pin

04=4Pin 05=5 Pin

F=Female

S=Dip Straight Pin

R=Dip Right Pin

N=No Ground Link Terminal

W=With Ground Link Terminal

N=No Locking W=With Locking

RHTECP NINGBO RHT ELECTRONIC CO.,LTD

UNITS:mm	SHEET SIZE: A4			SCALE:---	DRWN BY PAN
0~3	3~18	18~50	50~120	CHK'D BY FENG	
±0.12	±0.15	±0.3	±0.5	APPR BY ZHAN	

XLR Socket	
THIRD ANGLE PROJECTION	RHTAYLR-S09

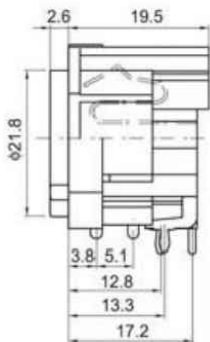
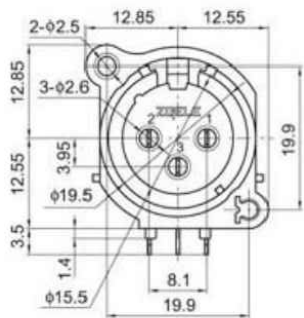

PCB LAYOUT
(VIEWED FROM COPPER SIDE)

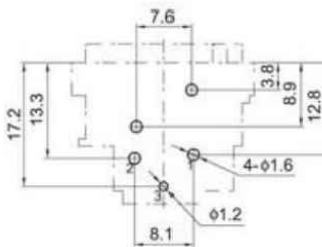

SCHEMATIC LAYOUT

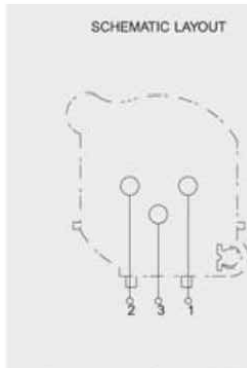

E Type Locking Pate
No Ground Link

Electrical Specification:
 Contact Resistance: $\leq 0.03\Omega$
 Insulation Resistance: $\geq 100m\Omega$
 Withstand Voltage: 500V AC (50Hz)/minute
 Rated Load: 50V DC, 1A
 Insertion And Extraction Force: 4-40N
 Temperature Range: -30°C to $+80^{\circ}\text{C}$

Order Information:

RHTAYLR-S09-03-F-S-N-W

XLR Jack Series.

03=3 Pin

04=4Pin 05=5 Pin

F=Female

S=Dip Straight Pin

R=Dip Right Pin

N=No Ground Link Terminal

W=With Ground Link Terminal

N=No Locking W=With Locking

RHTECP NINGBO RHT ELECTRONIC CO.,LTD

UNITS:mm	SHEET SIZE: A4			SCALE:---	DRWN BY PAN
0~3	3~18	18~50	50~120	CHK'D BY FENG	
±0.12	±0.15	±0.3	±0.5	APPR BY ZHAN	

XLR Socket	
THIRD ANGLE PROJECTION	RHTAYLR-S09

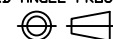

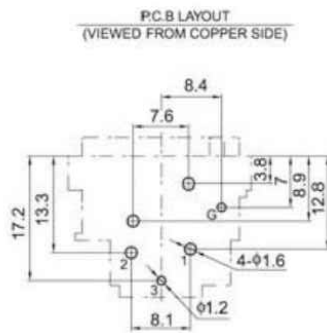
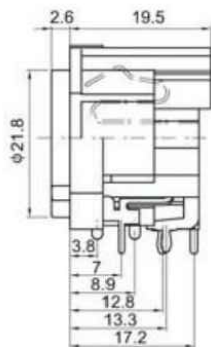
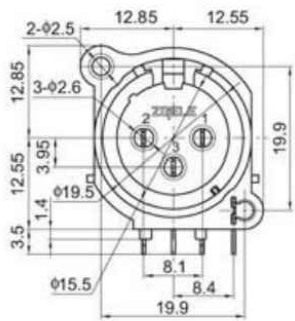

Electrical Specification:
 Contact Resistance: $\leq 0.03\Omega$
 Insulation Resistance: $\geq 100m\Omega$
 Withstand Voltage: 500V AC (50Hz)/minute
 Rated Load: 50V DC, 1A
 Insertion And Extraction Force: 4-40N
 Temperature Range: $-30^{\circ}C$ to $+80^{\circ}C$

Order Information:
 RHTAYLR-S09-03-F-S-W-W

XLR Jack Series.
 03=3 Pin
 04=4Pin 05=5 Pin
 F=Female
 S=Dip Straight Pin
 R=Dip Right Pin
 N=No Ground Link Terminal
 W=With Ground Link Terminal
 N=No Locking W=With Locking

E Type Locking Pate
 B Type Ground Link

RHTECP NINGBO RHT ELECTRONIC CO.,LTD

UNITS:mm	SHEET SIZE: A4			SCALE:---	DRWN BY PAN
0~3	3~18	18~50	50~120	CHK'D BY FENG	
±0.12	±0.15	±0.3	±0.5	APPR BY ZHAN	

XLR Socket	
THIRD ANGLE PROJECTION	RHTAYLR-S09