

Circuit Diagram

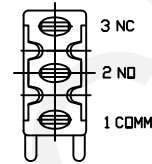
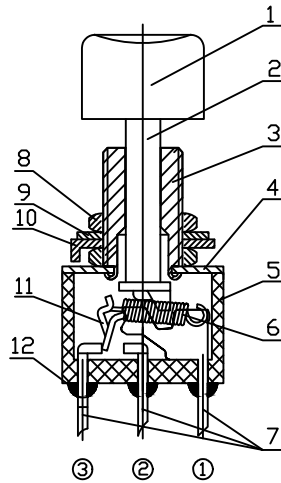

Specification:

Rating:1A 250V AC;3A 125V AC
 Contact Resistance:20mΩ Max
 Insulation Resistance: 1000MΩ/DC500V Min
 Withstanding Voltage:AC1000V/1Min
 Electrical Life:10000 Cycles
 Operating Temperature: -25°C~+85°C

ORDER INFORMATION

RHTGYPS-1C□-A4

Switching Position:
 Function: Without Lock

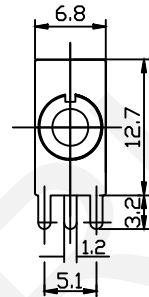
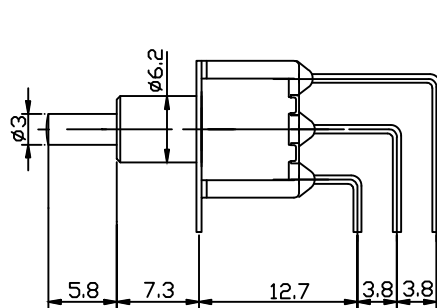

NO.	Parts Name	The Parts Of Material	Electroplating	RoHS
1	Pole	PA46	-----	RoHS
2	Spring	Steel wire	-----	RoHS
3	Bushing	Brass	Plate Nickel	RoHS
4	Supporting Part	Brass	-----	RoHS
5	Sliding Point	Bakelite	-----	RoHS
6	Housing	Bakelite	-----	RoHS
7	Movable Plate	Brass	Plate Silver	RoHS
8	Terminals	Brass	Plate Silver	RoHS
9	Steel Crust	Stainless Steel	-----	RoHS
10	Epoxy Seal	5010A/B	-----	RoHS

NINGBO RHT ELECTRONIC CO.,LTD

UNITS:mm	SHEET SIZE: A4	SCALE:---	DRWN BY PAN
0~3	3~18	18~50	50~120
±0.12	±0.15	±0.3	±0.5

CHK'D BY FENG
 APPR BY ZHAN

Momentary Pushbutton Switch

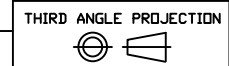

RHTGYPS-1C□-A4

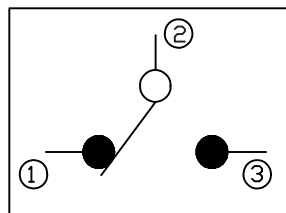

Circuit Diagram

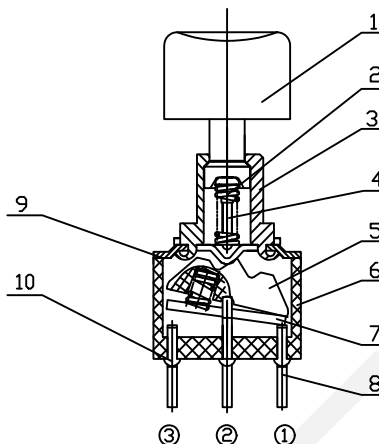

Specification:

Rating:1A 250V AC;3A 125V AC

Contact Resistance:20mΩ Max

Insulation Resistance: 1000MΩ/DC500V Min

Withstanding Voltage:AC1000V/1Min

Electrical Life:10000 Cycles

Operating Temperature: -25°C~+85°C

ORDER INFORMATION

RHTGYPS-1CQ-A4L

Switching Position

Function: L=With Lock

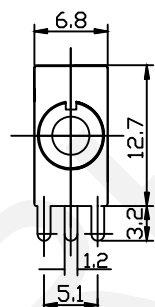
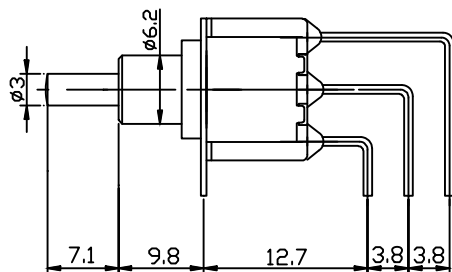

NO.	Parts Name	The Parts Of Material	Electroplating	RoHS
1	Button	PA46	-----	RoHS
2	Pole	PA46	-----	RoHS
3	Bushing	Brass	Nickel Plating	RoHS
4	Steel crust	Stainless Steel	-----	RoHS
5	Housing	Bakelite	-----	RoHS
6	Spring	Steel Wire	-----	RoHS
7	Terminals	Brass	Silver Plating	RoHS
8	Nuts	Brass	Nickel Plating	RoHS
9	Zigzag Washer	Stainless Steel	-----	RoHS
10	Fix Washer	Stainless Steel	-----	RoHS
11	Movable Plate	Brass	Silver Plating	RoHS
12	Epoxy Seal	5010A/B	-----	RoHS



NINGBO RHT ELECTRONIC CO.,LTD

UNITS:mm

SHEET SIZE: A4

SCALE:---

DRWN BY PAN

Momentary Pushbutton Switch

0~3

3~18

18~50

50~120

CHK'D BY FENG

THIRD ANGLE PROJECTION

±0.12

±0.15

±0.3

±0.5

APPR BY ZHAN

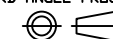

RHTGYPS-1CQ-A4L

1

2

3

4

5

6

7

8

9