

RoHS Compliance

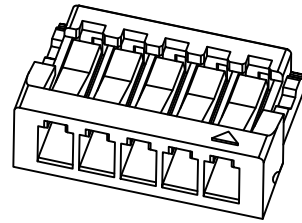

3D View

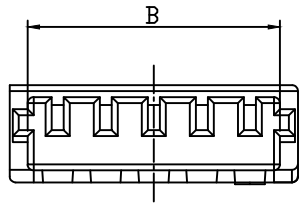
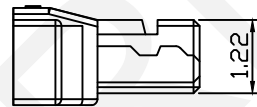
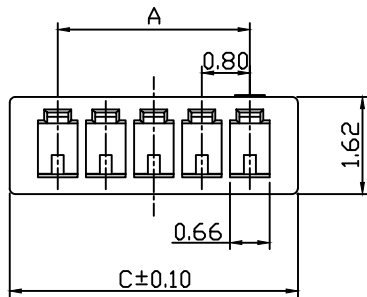
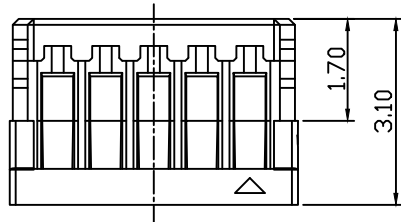

Circuit	Dimension(mm)		
	A	B	C
02	0.80	1.80	2.40
03	1.60	2.60	3.20
04	2.40	3.40	4.00
05	3.20	4.20	4.80
06	4.00	5.00	5.60
07	4.80	5.80	6.40
08	5.60	6.60	7.20
09	6.40	7.40	8.00
10	7.20	8.20	8.80
11	8.00	9.00	9.60
12	8.80	9.80	10.40
13	9.60	10.60	11.20
14	10.40	11.40	12.00
15	11.20	12.20	12.80
16	12.00	13.00	13.60
20	15.20	16.20	16.80

Material:

Housing: Nylon Or LCP, UL94V-0

Electrical Characteristics:

Current Rating: 0.5A AC, DC

Voltage Rating: 30V AC, DC

Temperature Range: -35°C ~ +85°C

Insulation Resistance: 100MΩ/Min

Withstand Voltage: 200V AC/Minute

Contact Resistance: 20mΩ/Max

Order Information

RHTAYL1-0.80-XX-H

Series No. _____

0.80mm Pitch _____

XX-No. of 2~20pin _____

Type: _____

H-Hosing T-Terminal

VM-Vertical SMT Pin

RM-Horizontal SMT Pin

RHTECP NINGBO RHT ELECTRONIC CO.,LTD

UNITS:mm	SHEET SIZE: A4	SCALE:---	DRWN BY PAN
0~3	3~18	18~50	50~120
±0.12	±0.15	±0.3	±0.5
CHK'D BY FENG		APPR BY ZHAN	

0.80mm Pitch SUR
Wire to board connector
THIRD ANGLE PROJECTION
 RHTAYL1-0.80-XX-H

RoHS Compliance

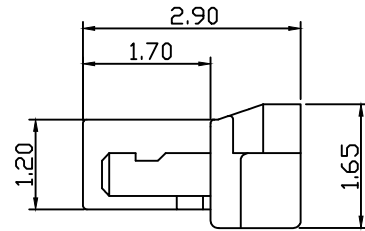
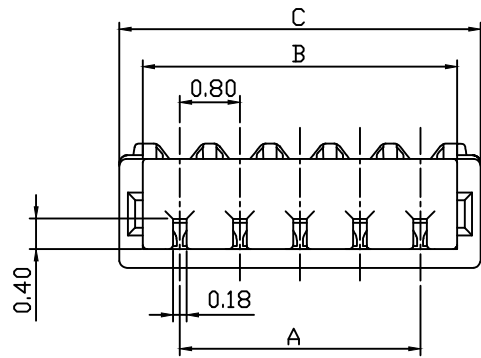

Material:
 Housing: Nylon66,UL94V-0
 Contact : Phosphor Bronze
 Plating : Plated Tin Or Gold Flash Lead Over Nickel
 Applicable Wire Range:AWG#32

Electrical Characteristics:
 Current Rating: 0.5A AC,DC
 Voltage Rating: 30V AC,DC
 Temperature Range:-35°C~+85°C
 Insulation Resistance: 100MΩ/Min
 Withstand Voltage: 200V AC/Minute
 Contact Resistance: 20mΩ/Max

Circuit	Dimension(mm)		
	A	B	C
02	0.80	1.78	2.40
03	1.60	2.58	3.20
04	2.40	3.38	4.00
05	3.20	4.18	4.80
06	4.00	4.98	5.60
07	4.80	5.78	6.40
08	5.60	6.58	7.20
09	6.40	7.38	8.00
10	7.20	8.18	8.80
11	8.00	8.98	9.60
12	8.80	9.78	10.40
13	9.60	10.58	11.20
14	10.40	11.38	12.00
15	11.20	12.18	12.80
16	12.00	12.98	13.60
17	12.80	13.78	14.40
18	13.60	14.58	15.20
19	14.40	15.38	16.00
20	15.20	16.18	16.80

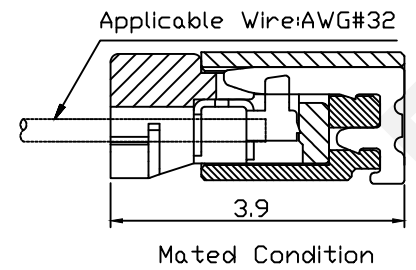
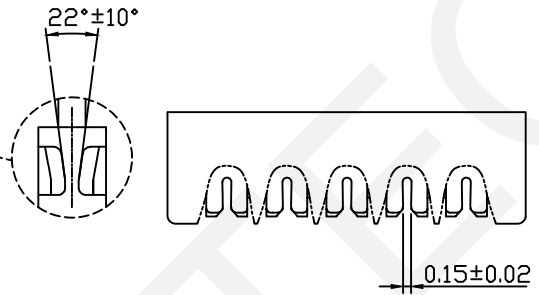
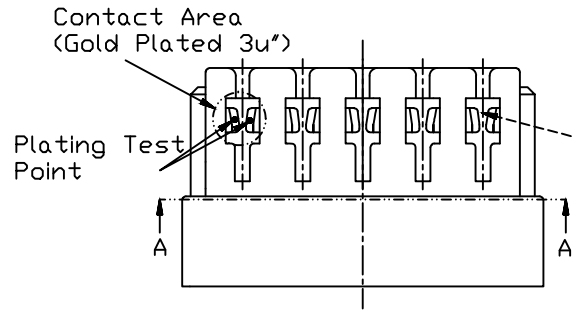

Order Information
RHTAYL1-0.80-XX-H1
 Series No. _____
 0.80mm Pitch _____
 XX-No.of 2~20pin _____
 Type:
 H1-Hosing T-Terminal
 VM-Vertical SMT Pin
 RM-Horizontal SMT Pin

RHTECP NINGBO RHT ELECTRONIC CO.,LTD

UNITS:mm	SHEET SIZE: A4	SCALE:---	DRWN BY PAN
0~3	3~18	18~50	50~120
±0.12	±0.15	±0.3	±0.5

CHK'D BY FENG
 APPR BY ZHAN

0.80mm Pitch SUR
 Wire to board connector
 THIRD ANGLE PROJECTION
 RHTAYL1-0.80-XX-H1

RoHS Compliance

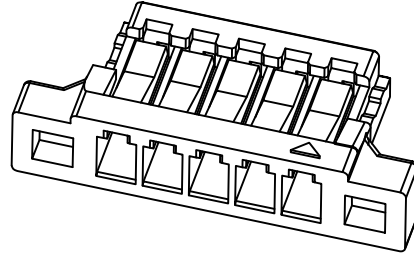
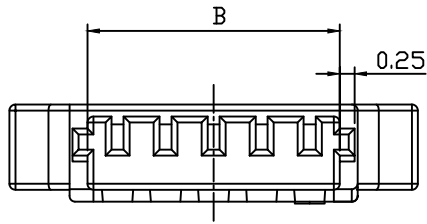

3D View

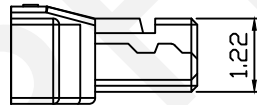
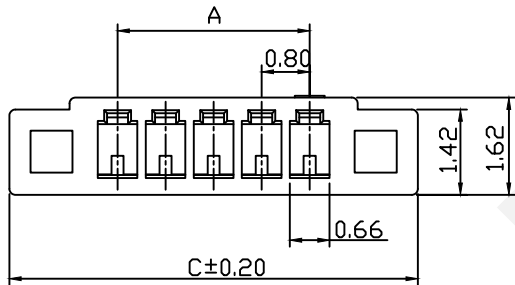
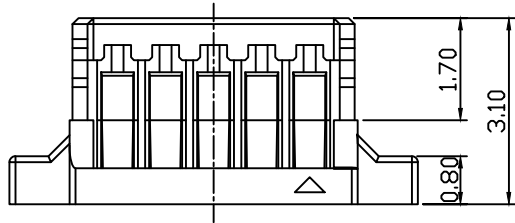

Circuit	Dimension(mm)		
	A	B	C
02	0.80	1.80	4.40
03	1.60	2.60	5.20
04	2.40	3.40	6.00
05	3.20	4.20	6.80
06	4.00	5.00	7.60
07	4.80	5.80	8.40
08	5.60	6.60	9.20
09	6.40	7.40	10.00
10	7.20	8.20	10.80
11	8.00	9.00	11.60
12	8.80	9.80	12.40
13	9.60	10.60	13.20
14	10.40	11.40	14.00
15	11.20	12.20	14.80
16	12.00	13.00	15.60
20	15.20	16.20	18.80

Material:

Housing: Nylon Or LCP, UL94V-0

Electrical Characteristics:

Current Rating: 0.5A AC,DC

Voltage Rating: 30V AC,DC

Temperature Range: -35°C~+85°C

Insulation Resistance: 100MΩ/Min

Withstand Voltage: 200V AC/Minute

Contact Resistance: 20mΩ/Max

Order Information

RHTAYL1-0.80-XX-H2

Series No. _____

0.80mm Pitch _____

XX-No.of 2~20pin _____

Type: _____

H-Hosing T-Terminal

VM-Vertical SMT Pin

RM-Horizontal SMT Pin

 NINGBO RHT ELECTRONIC CO.,LTD

UNITS:mm	SHEET SIZE: A4	SCALE:---	DRWN BY PAN
0~3	3~18	18~50	50~120
±0.12	±0.15	±0.3	±0.5

CHK'D BY FENG
APPR BY ZHAN

0.80mm Pitch SUR
Wire to board connector
THIRD ANGLE PROJECTION
 RHTAYL1-0.80-XX-H2

RoHS Compliance

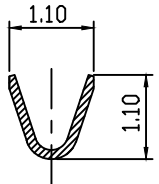
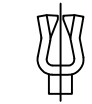
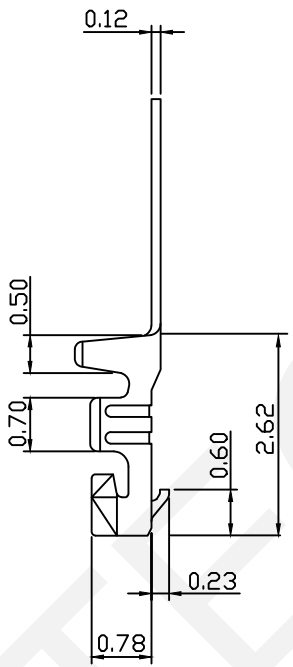
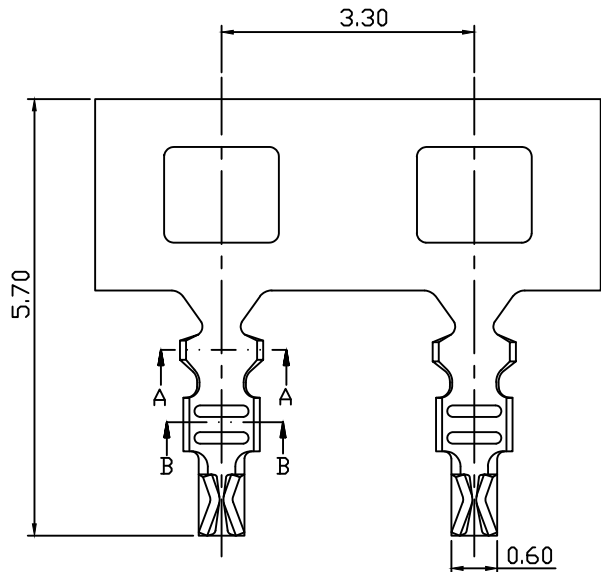

Section A-A

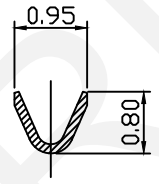

Section B-B

Order Information
RHTAYL1-0.80-T
 Series No. _____
 0.80mm Pitch _____
 Type: _____
 H-Hosing T-Terminal

Material:
 Terminal : Phosphor Bronze
 Plating : Plated Tin Or Gold Flash Lead Over Nickel
 Applicable Wire Range:AWG#32

Electrical Characteristics:
 Current Rating: 1.5A AC,DC
 Voltage Rating: 50V AC,DC
 Temperature Range:-25°C~+85°C
 Insulation Resistance: 100MΩ/Min
 Withstand Voltage: 500V AC/Minute
 Contact Resistance: 20mΩ/Max

Circuit	Dimension(mm)			
	A	B	C	D
02	0.80	1.90	3.78	3.04
03	1.60	2.70	4.58	3.84
04	2.40	3.50	5.38	4.64
05	3.20	4.30	6.24	5.44
06	4.00	5.10	6.98	6.24
07	4.80	5.90	7.78	7.04
08	5.60	6.70	8.58	7.84
09	6.40	7.50	9.38	8.64
10	7.20	8.30	10.18	9.44
11	8.00	9.10	10.98	10.24
12	8.80	9.90	11.78	11.04
13	9.60	10.70	12.58	11.84
14	10.40	11.50	13.38	12.64
15	11.20	12.30	14.18	13.44
16	12.00	13.10	14.98	14.24
17	12.80	13.90	15.78	15.04
18	13.60	14.70	15.58	15.84
19	14.40	15.50	17.38	16.64
20	15.20	16.30	18.18	17.44



NINGBO RHT ELECTRONIC CO.,LTD

UNITS:mm	SHEET SIZE: A4	SCALE:---	DRWN BY PAN
0~3	3~18	18~50	50~120
±0.12	±0.15	±0.3	±0.5
CHK'D BY FENG		APPR BY ZHAN	

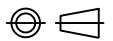
0.80mm Pitch SUR
 Wire to board connector
 THIRD ANGLE PROJECTION

 RHTAYL1-0.80-T

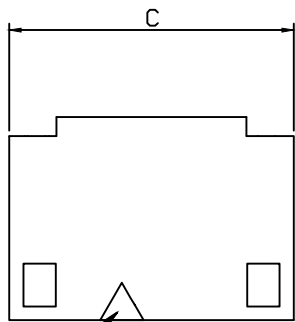
RoHS Compliance

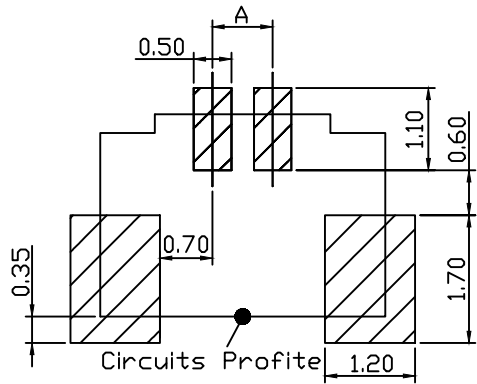

CKT1 MARK



Recommended PCB Layout
Total Tolerance±0.05mm

Order Information
RHTAYL1-0.80-XX-RM

Series No.
0.80mm Pitch
XX-No.of 2~20pin
Type:
H-Hosing T-Terminal
VM-Vertical SMT Pin
RM-Horizontal SMT Pin

Material:

Housing: Nylon Or LCP, UL94V-0

Terminal : Phosphor Bronze

Plating : Plated Tin Or Gold Flash

Lead Over Nickel

Applicable Wire Range: AWG#32

Electrical Characteristics:

Current Rating: 0.5A AC, DC

Voltage Rating: 30V AC, DC

Temperature Range: -35°C~+85°C

Insulation Resistance: 100MΩ/Min

Withstand Voltage: 200V AC/Minute

Contact Resistance: 20mΩ/Max

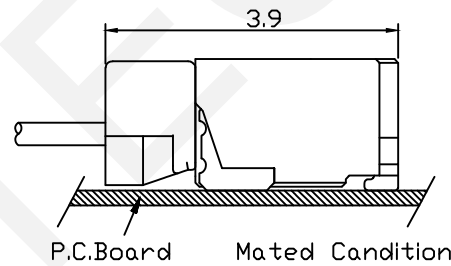
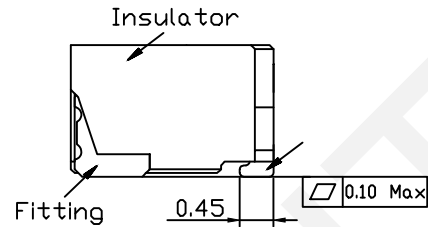
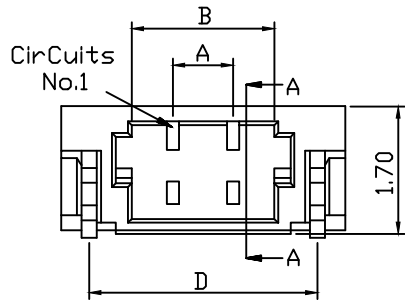

Circuit	Dimension(mm)			
	A	B	C	D
02	0.80	1.90	3.78	3.04
03	1.60	2.70	4.58	3.84
04	2.40	3.50	5.38	4.64
05	3.20	4.30	6.24	5.44
06	4.00	5.10	6.98	6.24
07	4.80	5.90	7.78	7.04
08	5.60	6.70	8.58	7.84
09	6.40	7.50	9.38	8.64
10	7.20	8.30	10.18	9.44
11	8.00	9.10	10.98	10.24
12	8.80	9.90	11.78	11.04
13	9.60	10.70	12.58	11.84
14	10.40	11.50	13.38	12.64
15	11.20	12.30	14.18	13.44
16	12.00	13.10	14.98	14.24
17	12.80	13.90	15.78	15.04
18	13.60	14.70	16.58	15.84
19	14.40	15.50	17.38	16.64
20	15.20	16.30	18.18	17.44

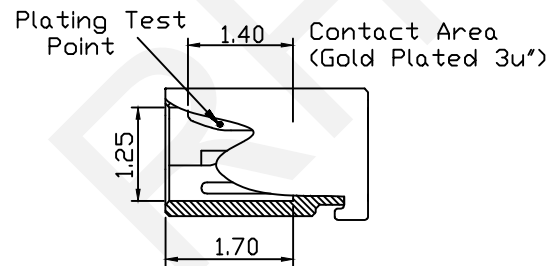
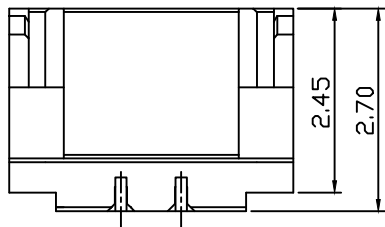

Section A-A



NINGBO RHT ELECTRONIC CO.,LTD

UNITS:mm	SHEET SIZE: A4	SCALE:---	DRWN BY PAN
0~3	3~18	18~50	50~120
±0.12	±0.15	±0.3	±0.5

CHK'D BY FENG
APPR BY ZHAN

0.80mm Pitch SUR Wire to board connector
THIRD ANGLE PROJECTION

RHTAYL1-0.80-XX-VM

RoHS Compliance

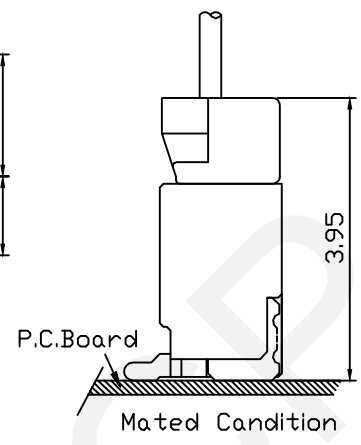
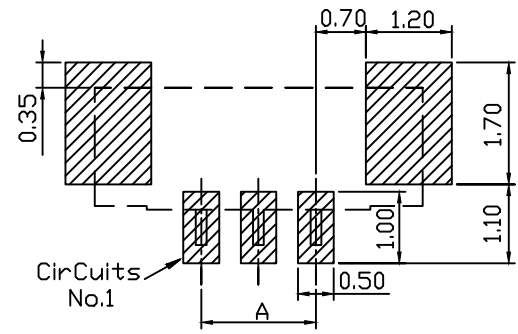
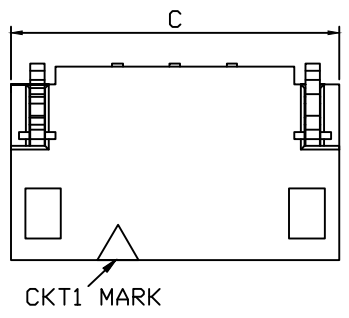

Material:
 Housing: Nylon Or LCP, UL94V-0
 Terminal : Phosphor Bronze
 Plating : Plated Tin Or Gold Flash
 Lead Over Nickel
 Applicable Wire Range: AWG#32

Electrical Characteristics:
 Current Rating: 0.5A AC,DC
 Voltage Rating: 30V AC,DC
 Temperature Range: -35°C~+85°C
 Insulation Resistance: 100MΩ/Min
 Withstand Voltage: 200V AC/Minute
 Contact Resistance: 20mΩ/Max

Circuit	Dimension(mm)			
	A	B	C	D
02	0.80	1.90	3.78	3.04
03	1.60	2.70	4.58	3.84
04	2.40	3.50	5.38	4.64
05	3.20	4.30	6.24	5.44
06	4.00	5.10	6.98	6.24
07	4.80	5.90	7.78	7.04
08	5.60	6.70	8.58	7.84
09	6.40	7.50	9.38	8.64
10	7.20	8.30	10.18	9.44
11	8.00	9.10	10.98	10.24
12	8.80	9.90	11.78	11.04
13	9.60	10.70	12.58	11.84
14	10.40	11.50	13.38	12.64
15	11.20	12.30	14.18	13.44
16	12.00	13.10	14.98	14.24
17	12.80	13.90	15.78	15.04
18	13.60	14.70	15.58	15.84
19	14.40	15.50	17.38	16.64
20	15.20	16.30	18.18	17.44

Recommended PCB Layout
 Total Tolerance ±0.05mm

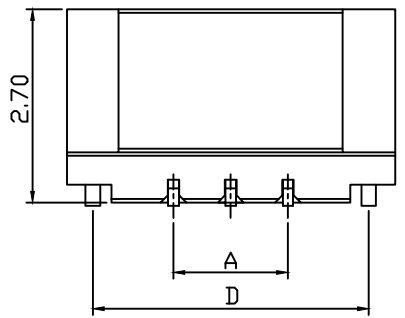
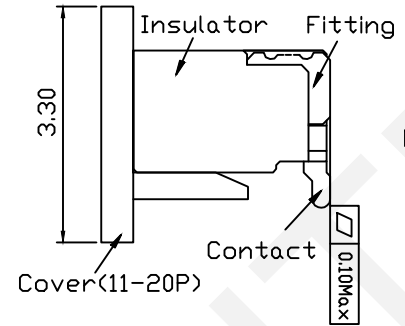
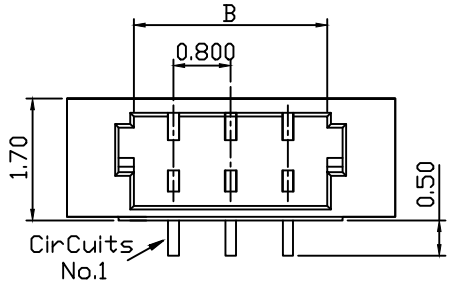

Order Information
 RHTAYL1-0.80-XX-VM

Series No. _____
 0.80mm Pitch
 XX-No. of 2~20pin
 Type: _____
 H-Hosing T-Terminal
 VM-Vertical SMT Pin
 RM-Horizontal SMT Pin

NINGBO RHT ELECTRONIC CO.,LTD

UNITS:mm	SHEET SIZE: A4	SCALE:---	DRWN BY PAN
0~3	3~18	18~50	50~120
±0.12	±0.15	±0.3	±0.5
CHK'D BY FENG		APPR BY ZHAN	

0.80mm Pitch SUR
 Wire to board connector
 THIRD ANGLE PROJECTION
 RHTAYL1-0.80-XX-VM